

Coordinate Measuring Machines Overview MICROCORD



History

The origins of the modern form of Coordinate Measuring Machine (CMM) lie in early 1960s Europe when electronic recording techniques were first applied to the two- and three-dimensional (3D) measuring machines that were needed for inspecting the output of the first generation of Numerically Controlled (NC) machine tools. Even though companies such as Moore in the U.S. and SIP in Switzerland had made Universal Measuring Machines (UMM) for many years these were slow in operation, mainly due to the necessity of manually recording positional readings for each axis, and when the new breed of NC machine tools appeared it was soon found that the UMM, although highly accurate and versatile, could not keep pace with the increased rate of production available, even when inspection was restricted to first-offs and low-rate sampling.

Mitutoyo also developed a Coordinate Measuring Machine, in 1968, called the MICROCORD A1 Series. This made use of vernier scales as the length measuring mechanism on each axis in a similar way to that used for analog calipers. The operator focused on a target point on a workpiece with a microscope fixed to the Z axis ram (the vertical direction moving element) and manually made a note of that point while reading each

vernier scale to determine its 3D coordinates, from which the workpiece dimensions were then calculated. Although such a measuring procedure appears somewhat daunting from today's perspective, this machine attracted the attention of potential customers at the time. However, since the machine's cost was equivalent to that of a family house with land at the time, it was not brought into production.

In time, Mitutoyo developed a scale that produced an electrical signal proportional to displacement, a sensor that automatically triggered this scale unit to send out a signal when a stylus came into contact with a workpiece as well as various processing units that eliminated the need for manual calculation, and then applied these technological advances to the wide range of Mitutoyo coordinate measuring machines that have become popular throughout the world.

At first, Mitutoyo was supplied with scales and processing units by other companies, but during the 1980s Mitutoyo developed all the necessary technologies in-house for manufacturing control units, scales, software programs and probes, etc., and thus became the only domestic manufacturer supplying CMMs for the support of global manufacturing.

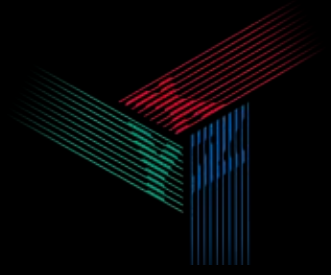

The most common application of a CMM is in final inspection of product components for quality assurance purposes. However, Mitutoyo CMMs are not only used for GO/NG judgment of finished products but also play their part in all aspects of manufacturing where fast and accurate measurement is needed, such as importing digitalized data of a mock-up created by a designer in a 3D CAD system. At first, a CMM had a high hurdle to clear when being considered for investment because it was perceived as a "non-productive facility". However, because of its ever-expanding field of application, the CMM reached the point where potential users started to plan its introduction even ahead of machining equipment.

The reason why a CMM is increasingly used in diverse measurement situations is due to its continuously increasing capability. In the case of Mitutoyo this has been achieved by systematically embodying the requirements of users into its

CMM line-up one by one. Additionally, in order to achieve "Industry 4.0" (the smart factory) for optimizing productivity and cost efficiency by visualizing the production site and product distribution by linking all measuring devices and tools, it is extremely important to control and maintain product quality. As a primary means of ensuring this, the CMM will continue to receive concentrated attention into the foreseeable future regarding user demand for further advancement. Therefore Mitutoyo will continue to work hard in supporting world manufacturing with leading-edge technologies.

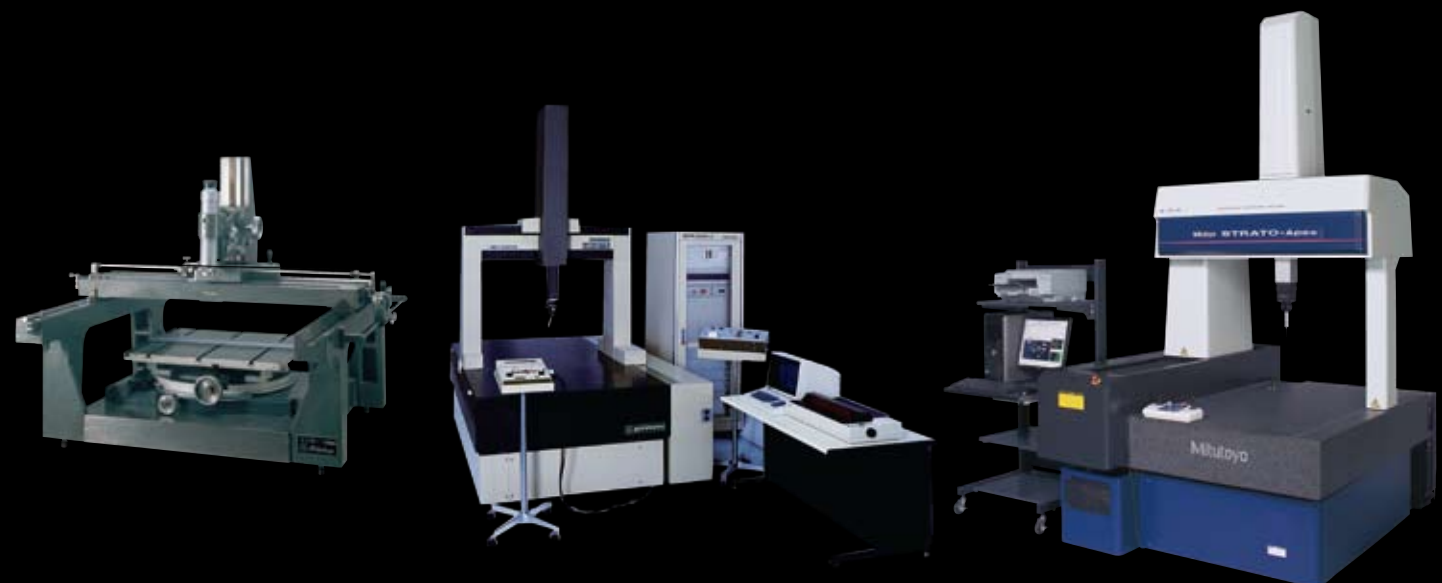

Automatic Measurement Program Generation Software

MiCAT-Planner

MSURF-Planner

— Bringing Part Program Creation Time Close to Zero —

Most Computer Numerical Control (CNC) CMMs are used to create an automatic measurement program (a part program) by means of so-called "Teaching" that copies the sequence of machine moves made while an operator actually measures a part and stores them as a part program to be used whenever the exact same kind of workpiece is measured. This procedure takes a considerable time and cannot be performed until at least one example of the part to be measured has been made. When a wide variety of products in small lots are produced, commensurately more part programs need to be generated. The effort of generating these programs, particular in the case of major manufacturers, means that this task is often handled

by outsourcing to specialists. CMMs and their part programs might well be called the keystone of quality manufacturing. Outsourcing of such a critical activity as part-program generation carries risks: for example, intimate product knowledge may be lost when a third party is involved. The manufacturer may find it difficult to understand the programmers methodology should problems arise in future that require program modification or analysis. This may cause problems with quality management, as a manufacturer may not be able to self-analyze potential issues inherent in the results and hence determine the cause of defectives.

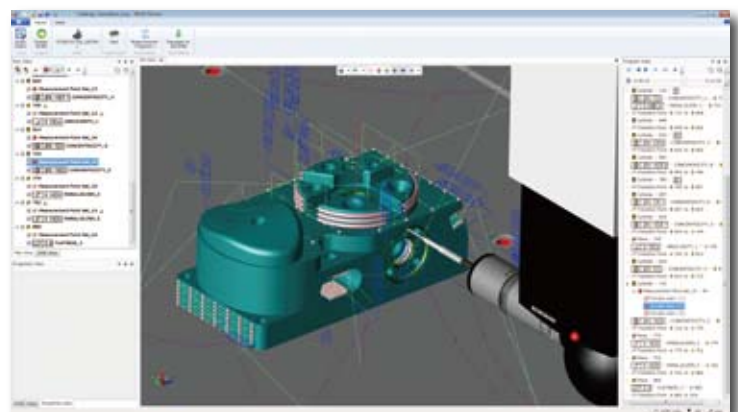

MiCAT-Planner



Software that allows part-program creation by simulation using 3D CAD models, before a part has been manufactured, has recently become available from CMM manufacturers. However, such systems have not yet become widely accepted because they specify data points one-by-one and thus cannot achieve much of a reduction in the man-hours required even when compared with the teaching method.

Mitutoyo has now achieved a significant advance with the launch of MiCAT-Planner. This software package automatically creates a part program from 3D CAD models that include

tolerancing information. This software provides major benefits such as (1) 95% reduction in part-program creation time; (2) enables anyone to create a part program; (3) reduces measurement time by optimizing data points; and (4) no need to learn operating procedures from scratch. This allows the design department of a company to specify machining information and inspection information in parallel, looking forward to the time when a CMM will support global manufacturing quality.

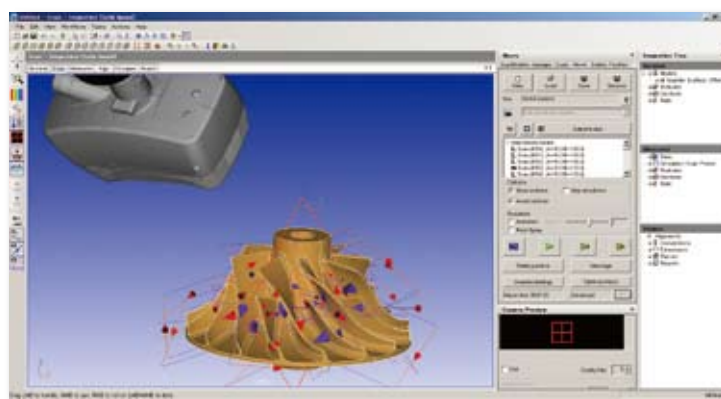

MSURF-Planner

Ultra-high Accuracy CNC Coordinate Measuring Machine LEGEX Series

— A CMM Trusted by Research Institutes throughout the World —

"Achieved an Uncertainty of less than 1 μ m"

Almost alone among the many CMM manufacturers, Mitutoyo has achieved an uncertainty in measurement (not a variation) of less than 1 μ m with a CMM when measuring a length of 500mm. CMMs with this performance are the top-end models from three world-leading CMM vendors and include Mitutoyo's LEGEX series*¹. A CMM system contains a large number of potential error sources such as imperfect axial motion, linear scale error, algorithm error, internal vibration, hysteresis, thermal influences and probing error. To achieve the 1 μ m measurement uncertainty performance mentioned above, the individual sources of error must be made vanishingly small because, in general, they are additive.

To realize this goal Mitutoyo has consistently worked toward development of fundamental technologies, which resulted in achieving a world-leading measurement uncertainty of 0.28 μ m in the first uncertainty term*² for the LEGEX. For example, stability of the main unit was maximized by adopting a fixed-bridge moving-table structure, uncommon in CMMs, to avoid the vibration inherent in moving-bridge designs, small though

it may be. The outstanding performance of the LEGEX series depended on developing a variety of new technologies, such as a proprietary type of glass scale with practically zero thermal expansion and a resolution of 0.01 μ m as the measuring system on each axis.

However, high performance of the CMM itself is not enough without a probing system of equal performance. Mitutoyo had to develop an ultra-high-accuracy scanning probe, the MPP-300, instead of using a commercially available touch-trigger probe for which the repeatability performance alone is often around 1 μ m. Also, the LEGEX series does not use the granite base that is commonly fitted to standard CMMs. Although granite is perfectly suitable for surface plates this well-known natural material is slightly porous and therefore subject to minute secular change because of the effect that humidity variation has on its dimensional stability, which renders it unsuitable for use in CMMs of the highest grade. This is the reason why Mitutoyo decided to use a cast-iron base for the LEGEX, even though the cost was higher.

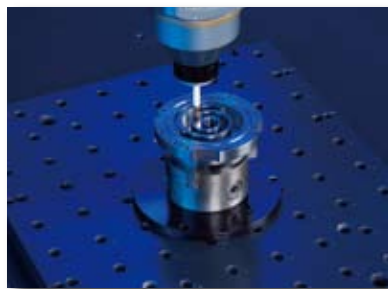



This is just one example of the attention to detail that has gone into developing the LEGEX system but there are other aspects equally as important. For example, it is not enough just to pursue the ultimate in accuracy and stability of mechanical structures and parts, for however much the performance of a CMM is improved the effects of thermal expansion are unavoidable. It is a fact that a 100mm-long steel rod will change in length by about 1µm if the temperature changes by only 1°C. Therefore the LEGEX incorporates a highly effective thermal compensation system that enables its outstanding accuracy to be maintained over the range 19-21°C.

Even after implementing the abovementioned features there were still many factors that could affect measurement accuracy, such as external vibration. In order to maintain measurement uncertainty within 1µm, it was necessary to tackle a wide variety of potential error sources and remove or minimize them one by one.

LEGEX has an active role wherever extremely high measuring accuracy is required, such as in the support of ultra-precision machining of parts such as gears, ball screws, bearings, and similar in the moldmaking, space and aeronautics industries, and has truly pushed Mitutoyo quality to new heights.

The name "LEGEX" is derived from LEGEND and EXCELLENT, which suits a CMM that has earned an excellent reputation as a reference measuring machine in many research institutes and major development divisions of companies across the world.

*1: Result of in-company survey in September 2016

*2: The accuracy of a CMM is commonly expressed in the form of a measurement uncertainty figure given by $A + BL$ (A, B: arbitrary values determined by calibration, L: measured length) where A is called the "first term". The smaller the value of $A + BL$, the higher the measurement accuracy.



LEGEX 574



LEGEX 776



LEGEX 9106

High Accuracy CNC Coordinate Measuring Machine STRATO-Apex Series

— Supporting Ultraprecision Machining Technology —

"What is the guaranteed accuracy of this CMM ?" This is a Frequently Asked Question posed by potential customers but is a little difficult to answer without more information. When this question is addressed to a CMM manufacturer, the CMM accuracy (nominal value in the catalog) is usually sent back in response. However, the customer should be aware that "CMM accuracy in the catalog" is not equivalent to "guaranteed accuracy of the product (part)".

The answer that the customer actually wants depends on whether the question was asked with an eye to the guaranteed quality of the customer's product or merely about the performance of the CMM itself.

Well, suppose the customer asked this question with a view to whether product accuracy can be guaranteed: 'How accurate

does my CMM need to be?'

It used to be said that a measurement should ideally be made with an instrument 10 times more accurate than the tolerance. Thus, in the case of a tolerance of $\pm 0.005\text{mm}$ on a 100mm dimension a CMM should have a measuring uncertainty of 0.0005mm ($\pm 0.5\mu\text{m}$) at this length to be in accord with this statement, and this cannot be met with a standard CMM.

However, the requirements of the marketplace for product quality are becoming more severe from day to day and thus the required accuracy of precision parts is becoming increasingly higher so that we now commonly see much tighter tolerance specifications and the traditional ten-to-one ratio then becomes unrealistic when using a standard CMM.





In view of this situation, if a customer insists on a CMM with ultra-high accuracy to the degree of one-tenth the accuracy of a product then a big investment for a top-class CMM is required, and this may be difficult to recover. In general, it is advisable to strike a balance between cost and performance of equipment. According to our experience, the accuracy of a CMM is sufficient if its uncertainty of measurement is no more than 1/5 or so of a dimensional tolerance. This has been proved to be a realistic value obtained from various inspections. Therefore, in the case of a $\pm 0.005\text{mm}$ tolerance, product quality can be guaranteed if the CMM used has a specified catalog uncertainty of $1\mu\text{m}$ or so. Still, a CMM with such high accuracy

was extremely costly until now but Mitutoyo has developed the STRATO-Apex Series that supports such high-accuracy manufacturing in terms both of accuracy and cost factors. While laying emphasis on cost-reduction, this series has also adopted the same zero-expansion glass scale (as used on the LEGEX) as a key technology and is equipped as standard with the auto-leveling/vibration-damping unit, thereby incorporating features that enable exceptional accuracy to be achieved in a top-end moving-bridge CMM. The name "STRATO" is derived from STRATOSPHERE, signifying that this is a CMM with an ultra-high level of accuracy at a cost comparable with that of a standard-class machine.



STRATO-Apex574



STRATO-Apex9106



STRATO-Apex 163012

CNC Coordinate Measuring Machine CRYSTA-Apex S/EX Series

— Best-selling Machine Supporting Manufacturing in a Wide Range of Industries —

A new concept by which a variety of measurement is performed using a measurement sensor in place of a tool mounted on the machine tool's head has become popular. "On-machine Measurement" indicates the measurement of a workpiece while it is still clamped on the machine tool, which has obvious advantages if that measurement is reliable. However, it should be remembered that this concept has a problem in that it is extremely risky to believe an evaluation result obtained from such measurement without understanding its limitations. Implementation of machining and measurement with the same machine is primarily something like auditing one's work oneself. Unless an audit is performed by a third party, any critical problem could be overlooked.

The basic problem with measuring a part using the same machine tool that produced the part is that any error in positioning accuracy or dynamic accuracy will largely be repeated in both operations and so any error will, in general, go undetected. Furthermore, if the accuracy of the machine tool is always changing then such change will go unrecognized. Also, deformation caused by clamping a part can only be detected when it is released, and so this form error too will go undetected. In order to evaluate a part reliably it is essential to evaluate it using other measuring equipment. Quality control of components incorporated in products on which people's lives depend often mandate that measurement is made by different operators on different CMMs.





In the late 20th century, a CMM was so expensive that its price was several times more than a machine tool. Nowadays, a CNC CMM with a measuring range of 500mm costs several million yen, allowing acquisition at about one-third the price at its first appearance. Since CNC CMMs can guarantee an accuracy of several micrometers or so in a temperature environment of 16 to 26°C without using a temperature controlled chamber, they have become widespread and several tens of thousands are now operating in Japan.

What are the requirements from CMM manufacturers? Reliability, convenience, high accuracy, efficiency, low price, multi-functionality, user-friendliness, etc. The priority assigned to these attributes differs depending on the customer. A customer sometimes may ask for multiple requirements that

are in conflict with each other. The requirements of high speed and high accuracy, or multi-functionality and user-friendliness correspond to such cases. The CRYSTA-Apex/EX is a CNC CMM that was developed by a full-scale development effort to try and meet the above requirements, wherever possible, with only a single machine. This series is Mitutoyo's mainstay product that has sought a best-in-class accuracy guarantee and throughput improvement thanks to a high-speed/high-acceleration drive system working in the wide temperature environment of 16 to 26°C .

The name "CRYSTA" is derived from CRYSTAL. This word represents the desired shining reputation of products manufactured by our customers.



CRYSTA-Apex EX 544T



CRYSTA-Apex S 9106



CRYSTA-Apex S 122010

In-line Type CNC Coordinate Measuring Machine MACH-V/3A/Ko-ga-me Series

— Achieving Numeric Management in the Production Line —

In the production area of a manufacturing operation there are many types of length measuring tools and instruments such as line standards, calipers, micrometers and height gages together with end standards such as gauge blocks, plug gages and snap gages. These tools, although very handy, can only perform single dimensional evaluation at a time and thus may not be able to effectively measure a complex workpiece with many important dimensions to be checked. For example, they cannot evaluate positional deviation and runout.

This being the case, such tasks may be handled by manufacturing a dedicated gage that combines a measuring tool with a fixture. Although it is impossible to measure the circular runout of a round part using only a dial indicator, it is possible to evaluate runout by manufacturing a fixture that allows the dial indicator's contact point to come into contact with the circumference of the part and rotating it around its axis.

However, a dedicated gage to measure more complicated and advanced products such as car engine parts will be so complex that it may cost several million yen. And a dedicated gage like

this must basically be remanufactured if product dimensions or form are changed. Today, where every product life cycle is becoming shorter, the cost required for dedicated gages is ever-increasing. Additionally, measurement using a gage is called "comparative measurement" and always needs a standard such as gauge blocks or a master workpiece (reference workpiece for zero-setting the position of each sensor in the gage).

Because of the higher degree of commonality achieved between parts for the purpose of cost-cutting, multiple companies have globally produced the same part, thereby needing a large number of master workpieces required for dedicated gages. As a result, if there is a difference (variation) between those master workpieces it will cause an issue resulting in a difference in quality between company B in country A and company D in country C. Moreover, there is another issue in that measurement with a gage makes it difficult to feed back corrective action to machine tools since this type of measurement is mainly intended for OK/NG judgment and is not suited for grasping how much a machining point is deviating and in which direction.

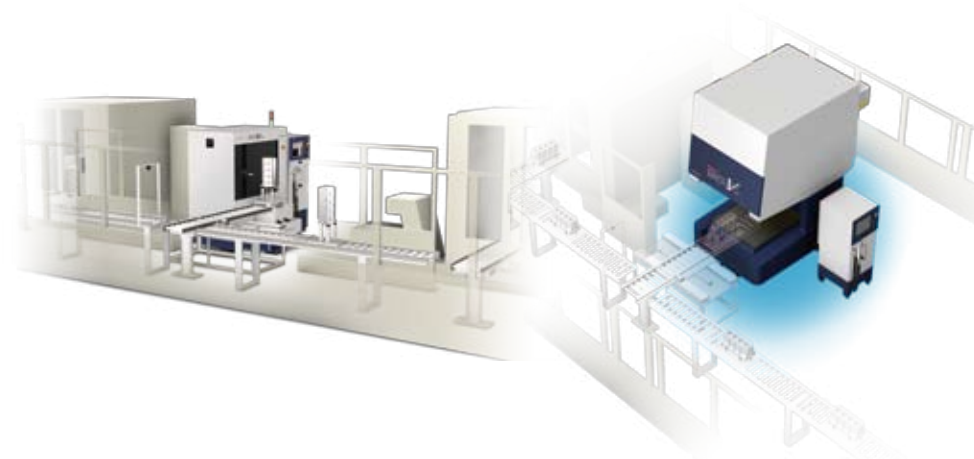



Since the debut of the CMM in the market, it has been mostly used for measurement of complicated components such as car engine parts. Until the latter half of the 1990s, the CMM could only deliver its maximum performance in an inspection room controlled at 20°C and, particularly, the manual CMM was very slow. For these reasons the CMM played a role completely different from that of measuring tools and gages in a production area. For example, it was used for evaluation of a trial product or sampling measurement of several pieces per day from among mass-produced goods. That is why a CMM was seldom used for in-line or line-side measurement.

In order to globally implement high-level quality management of products, however, the "comparative measurement" methodology using dedicated gages had limits on its measurement capability. On the other hand, a general-purpose machine like a CMM allowed "absolute measurement" while supporting multi-product measurement capability. It was clear from the results that installation of a CMM in a production line

or on the line-side made it easier to meet various measurement challenges and also led to cost-cutting of production in the medium-to-long term. Certainly, there were still many problems remaining to install the conventional bridge-type CMM for long continuous operation in a production line and thus a new-concept CMM to resolve these problems needed to be developed.

Therefore Mitutoyo developed and launched the MACH series as a complete in-line compatible CNC CMM. With a superfast drive on all axes and 5-40°C wide-range thermal compensation function (MACH-3A), this series provides absolute measurement combined with easy integration and highly efficient operation in a production line. A further development, the MACH Ko-ga-me series, is a lightweight CNC CMM with a small measuring range but very fast action that is the first of its type in the world. This series not only allows stand-alone installation but also provides a revolutionary solution that enables installation on machine tools and associated equipment.



MACH-3A 653



MACH-V9106



MACH Ko-ga-me

Large Separate Guide Type CNC Coordinate Measuring Machine FALCIO-Apex G Series Crysta-Apex CG Series

— A Reference Machine for Measuring Large Parts —

CMMs are increasingly employed for high-accuracy dimensional evaluation of extremely large components such as aircraft parts, machine tool parts, construction machine parts and car-body molds. However, if a large CMM with a measuring range of 2m or more in bridge width were manufactured with a conventional granite base it would be too big to be transportable on public highways. Therefore, Mitutoyo has adopted the "gantry" structure for CMMs of this class. In this structure, two huge parallel guide rails are installed on the floor

and a bridge structure carrying the probing system runs on them like an electric train on rails. This allows each guide rail to be separately transported and built up on site.

Nevertheless, this structure has one major drawback because of the lack of a highly rigid base. There are several CMM manufacturers in the world which employ this structure where the guide rails are fixed to the floor with several anchor bolts, thus causing the rails to deform according to the contour of the floor.

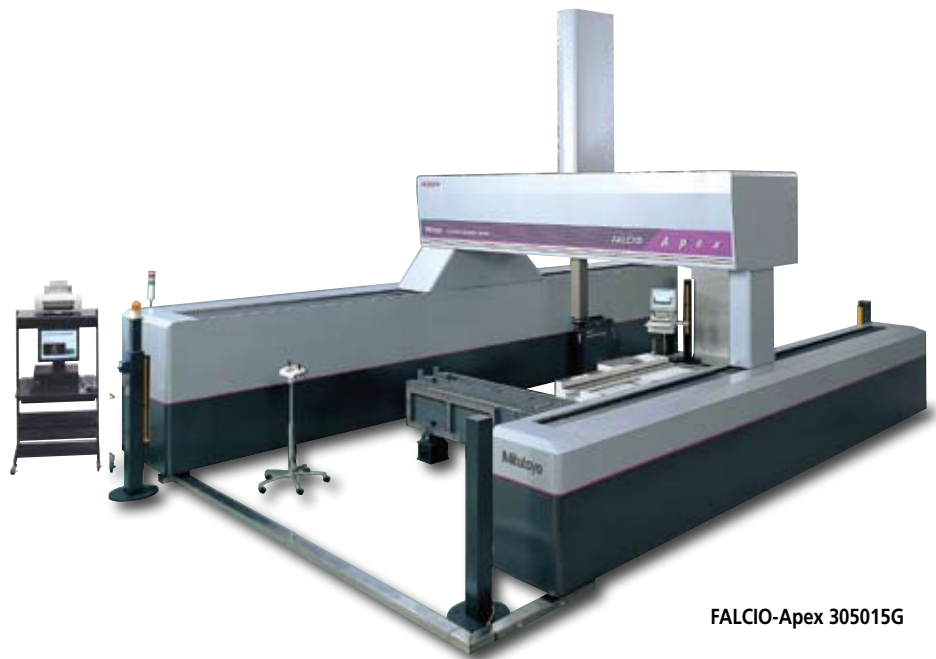

FALCIO-Apex 305015G

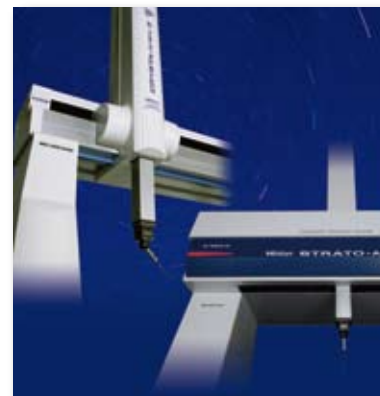

But however robustly the fundamental construction is executed, variations in the floor contour due to unavoidable secular and seasonal change in temperature is unavoidable. This obviously has an adverse effect on the CMM's accuracy. To solve this problem, Mitutoyo employs a particular type of structure where the guide rails are supported at two optimal points so as not to be subject to changes in floor contour, and the support and guide rail are not completely fixed which allows for guide rail

expansion and shrinkage due to temperature changes. Mitutoyo has also developed a unique floor deformation compensation system (MOVAC: Mitutoyo Onsite Volumetric Accuracy Compensation system) to compensate for secular and seasonal change in floor contour. The Crysta-Apex is equipped with this epoch-making system that allows customers themselves to prevent adverse effects on CMM accuracy due to changes in floor contour over time.



Crysta-Apex C306020G

Horizontal Type CNC Coordinate Measuring Machine CARB-Strato/Apex

— Putting a Beautiful Design into Tangible Form —

Car design — flowing form, distinctive character line, flaw-free beautiful coating, etc. These highly desirable attributes begin with design. A sketch of the designer's concept is first converted to 3D CAD data, from which quarter- and full-scale clay models are fabricated, and then design for prototype to mass production is launched. Since the start of this century it has become apparent, particularly in the auto industry, that the full use of computer simulation technology allows virtual engineering of the entire process from product design to manufacture and inspection without fabrication of physical models.

There actually exists a carmaker that has developed a new car without fabrication of clay models by using 3D CAD. On the

other hand, however, there is also at least one carmaker that fabricates clay models in order to put "life" into a car design and for finalizing details. This may be explained by a difference in the way of thinking and working of individual carmakers. Nevertheless, as the 3D printer grows more sophisticated, trial manufacture of parts using a 3D printer is getting started for car interior verification.

In this development process, a CMM is not only used for evaluation of machined parts. A CMM makes the most of its capabilities in various situations such as conversion of a clay model to 3D data and evaluation of moldmaking for car panels in the development, design and manufacturing phases as well as the quality assurance function.





The CARB series is a horizontal-arm CNC CMM which allows the whole car body to be measured on both sides if two machines are mounted horizontally opposed (Dual-arm type). This series delivers both the world's highest moving speed and measuring accuracy in this class and can maintain this accuracy over an extended time period by virtue of its unique 3-point support for the base which is insensitive to changes in the foundation (for the Strato: types up to 6m in the X axis). Taking harsh operating environments into consideration, a dust-proof cover is fitted to all axes (for the Strato this allows a person to walk on the cover on the X-axis base) in addition to a temperature compensation function as standard equipment. This series has further received full attention to safety design for

the dedicated control box with a 3-position dead-man switch, sensors built into the Y-axis bellows to trigger an emergency stop before the Y-axis ram comes into abnormal contact with any object such as a workpiece, area sensors (optional) to trigger an emergency stop when an operator enters the machine operational area during automatic measurement, and others.

The name "CARB" is derived from CAR BODY. This series plays an active role in a variety of fields such as manufacturing construction-machine parts, building materials, electricity generator parts and liquid crystal panel parts as well as automobile parts.

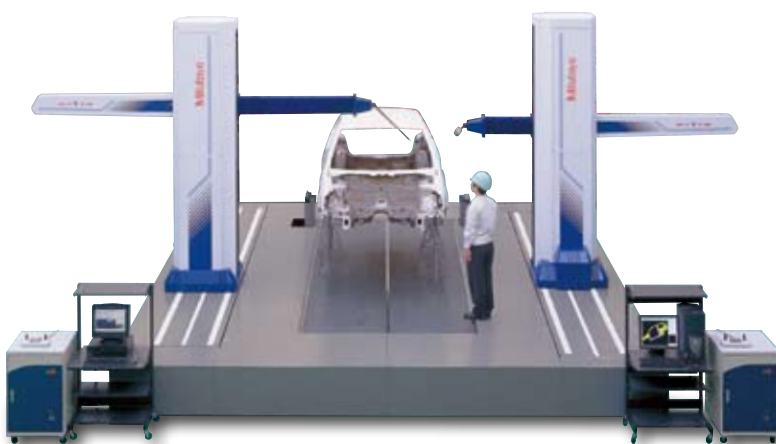

CARBstrato 601624D (Dual type)

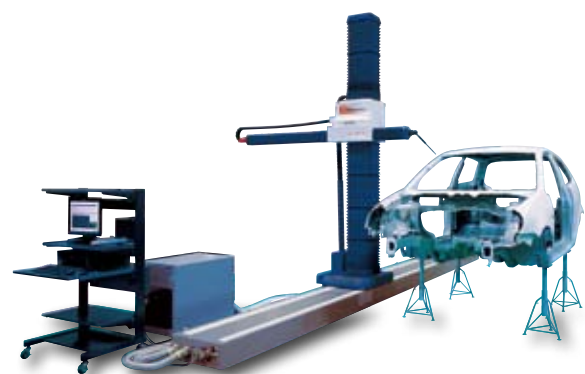

CARBapex 601624 (Single type)

In-line Inspection System MAPVISION Quality Gate Series

— Achieving 100% Workpieces × 100% Items Inspection —

Since about the year 2000, camera-equipped CMMs have become widespread. Some of them obtain the position of a workpiece surface with a projected target, and others obtain 3D data from a workpiece by the light-section method where a slit-like laser beam is shone on the workpiece surface and a CCD camera receives the reflected light, from which the position of each point on the surface is acquired by triangulation. Since the first camera systems were strongly sensitive to the surface color and condition of a workpiece, it was necessary to coat the surface with powder or degloss the surface luster with a solvent if the surface was strongly colored or too glossy.

Recently, a CMM with a cabinet resembling a large projector has rapidly become commonplace, particularly for car body inspection. This is a measuring machine mainly based on the principle of the phase shift method by which the machine

determines a distance from an object by using the phase difference between reflected light from the workpiece and reference light obtained from the same light source while irradiating the workpiece with laser beams modulated in multiple grid patterns. This “light-section” method only allows data acquisition of one section and thus needs to swing the laser beam to acquire plane data. The use of this method enables tens of thousands to hundreds of thousands of plane data points per second to be acquired as coordinate information. The camera-equipped measuring machine performs measurement while being moved around a workpiece with the machine installed on a stand (or tripod) or while rotating a workpiece so as to cover all visible areas. (In each case, all measurement data are combined by various methods.)



The disadvantage of these measuring machines is that setting of a workpiece must be redone when measuring multiple data points although measurement of one point is as quick as several seconds. As an example, it finally takes tens of minutes to measure a large workpiece such as a door panel (including hole positions and surface heights). Even if a robot is used, as data points increase in number, it requires more time to move the robot to each additional point.

In contrast, Mapvision's Quality Gate system offered by Mitutoyo is a mold-breaking system which can measure data points on a workpiece at one stroke with several tens to a hundred small cameras and illumination units arranged in the measuring machine cabinet. The system allows ultra-high-speed measurement in a matter of seconds because there are no moving elements. Preinstalling a number of small cameras and auxiliary illuminators at necessary locations enables all data

points to be measured.

The Quality Gate checks whether the correct parts are mounted in their proper locations as well as measuring hole positions and surface heights, thus enabling evaluation of assemblies such as welded car body parts and even complete chassis. Quality Gate is "100% workpieces/items measurement". The system not only eliminates an influx of defectives into post-process, but also feeds back, at the world's highest speed, data needed for quick convergence and optimization of variations in parts upon start-up of production. It can also reevaluate the parts on the data based on information about defectives at the design/development phase which are turned out later due to prolonged storage and identify individual product in which any defective has been installed, thereby contributing to costcutting by enabling pinpoint response to a defective.



Quality Gate 4200

Manual Type Coordinate Measuring Machine CRYSTA-Plus M Series

— The CMM that is Just Like Using a Regular Gage —

Conventional CMMs are categorized into two kinds: the manual type that is operated while holding and moving the Z-axis ram by hand around a workpiece, and the CNC type that enables automatic measurement under numerical control. The first CMM that appeared on the market was a manual type. Even after the CNC CMM was launched in the 1980s, the mainstay of the industry was still the manual CMM until the first half of the 1990s. As CNC CMMs became cheaper in the latter half of

the 1990s this type became dominant.

However, the manual CMM still plays an active role even now because of advantages such as: (1) capability of measurement without needing to create a part program as does a CNC CMM; (2) simple measurement of only the required points just like using a regular gage; (3) only one-half the cost of a CNC CMM (3 million yen or so); (4) low maintenance cost.

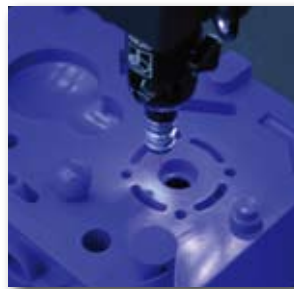



The CRYSTA-Plus M series manual CMM has achieved unparalleled accuracy assurance in the temperature range of 15 to 30°C, thereby allowing production inspection with the simplicity of a gage. This series is equipped with many features in pursuit of operability, such as handy illumination for helping to measure intricate workpiece detail (544/574), fine-feed knobs

arranged at one convenient location when using a microscope (443/544), and a constant force grip for reducing measurement variation among individual operators (776).



Crysta-Plus M443



Crysta-Plus M574



Crysta-Plus M7106

Multi-axis Portable Coordinate Measuring System SpinArm-Apex Series

— A Portable, Compact Machine —

In the 1980s, a CMM based on a completely different concept made its appearance. This CMM, developed for a prosthetic limb maker, was a multijoint articulated arm type without the Cartesian coordinate scales of the conventional bridge-type structure. The conventional bridge type CMM is structured so as to define any given spatial point as its X, Y and Z coordinates relative to an arbitrary reference point using scale units in each of the orthogonal axes. In contrast, a multijoint articulated arm type CMM is structured so as to define a given point in terms of spherical coordinates (radius r and two angles θ , ϕ).

The biggest feature of this CMM is "portability". A conventional CMM cannot measure a workpiece unless the workpiece, however large or heavy, is loaded onto the machine (or set within the measuring range). On the other hand, a fully articulated arm type CMM is lightweight and portable, thus allowing it to be moved close to a workpiece even if it needs a measuring range of 3m or more. The arm type CMM also allows a part being worked to be measured without removal from a machine tool, or process, while it is being worked on. This is a huge advantage from the viewpoint of measurement efficiency.



NEW-STYLE
Coordinate Measuring Machines



The principal driver for development of this type of CMM for the prosthetic limb maker was the need for portability above all other considerations. Although a bridge type CMM cannot measure a workpiece which is larger than its measuring range, an articulated arm type CMM can do this by using the technique of linking measurement results gathered from multiple positions around the workpiece.

At first, Mitutoyo imported and sold foreign-made articulated arm type CMMs. (Software was proprietary to Mitutoyo.) In 2013, Mitutoyo released the in-house developed SpinArm-

Apex CMM series. Around the same time, Mitutoyo successfully developed and manufactured line laser sensors, which had depended on third-party products until then, and non-contact systems equipped with those sensors are now put to use by customers for a wide variety of purposes, such as inspection of molded goods and reverse-engineering procedures.



SpinArm-Apex 186H



SpinArm-Apex 367H



*Not for use and/or export to the United States of America.

SOFTWARE

— The Enabler of Multiple Measurement Technologies —

The principal reason that the performance of CMMs has dramatically improved in recent years is that, quite simply, the software technology has advanced. For example, in evaluation of holes and bores the old software only calculated circle features (hole diameter and center coordinates) from 3 measurement points. The latest software has no limit to the number of measuring points and provides multiple functions which allow you to select a calculation formula from mean circle, circumscribed circle or inscribed circle, and the measuring method as point-to-point or scanning in order to evaluate roundness, positional deviation, tolerance verification, and fit in addition to diameter and center coordinates.

Although there exist several tens of CMM manufacturers in the world, not so many of them develop the associated software.

Software development seems endless and requires an enormous amount of time and energy and in fact most manufacturers are supplied with software from other companies. Mitutoyo started in-house development of software in the 1970s. In the 1980s Mitutoyo also developed the hardware for data processing units, which have become increasingly widespread due to the popularity of manual CMMs. In the 1990s, while the emphasis was changing to CNC CMMs, Mitutoyo installed in-house developed software on commercial PCs which were becoming increasingly cheaper. Since software for evaluation of curved surfaces and gears, as well as conventional dimensional evaluation, was developed and installed on a PC the field of application of the CNC CMM has greatly expanded.

CAT1000P [ON-Off-line teaching program]

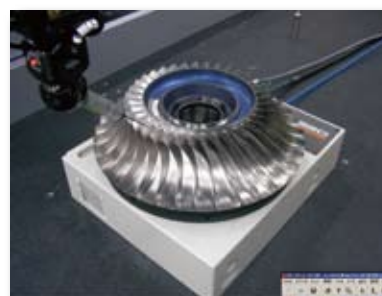
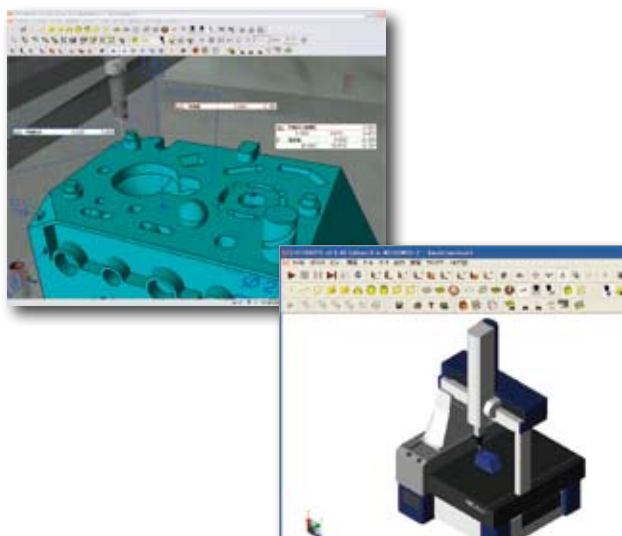

CAT1000S
[Curved surface evaluation program]

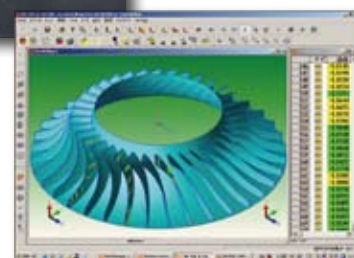

The recent advancement of cooperation with 3D CAD has allowed a CMM not only to perform comparative tolerance verification between measurement data and design data with numeric values or visually, but also to assist correction by feeding measurement data back to manufacturing. Furthermore, with the capability to automatically program the CMM using CAD data, etc., the CMM has enabled a solution for a drastic reduction of effort on jobs that conventionally required much time and manpower through a trial and error process.

The future world will see a drive toward cooperation of labor between facilities and humans with the aim of achieving a

smart factory by connecting all devices together through the Internet (IoT: Internet of things), visualizing a variety of information on such as development, production, quality and distribution and clarifying the cause-and-effect relations between pieces of information. At this time, software will play an increasingly important role. Mitutoyo intends to offer various solutions always with a focus on "quality" in this new era of manufacturing technology. While contributing our energy to software development more than ever for that purpose, Mitutoyo promises to deliver epoch-making solutions using the synergies of our comprehensive technologies of mechanics, electrics, electronics, optics, materials, control and computing.

GEARPAK [gear evaluation program]

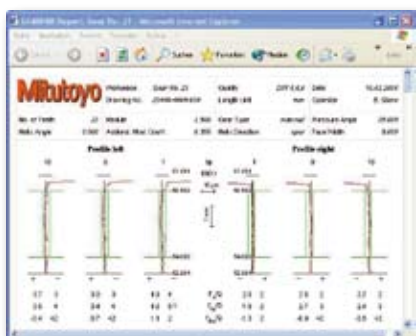

ROUNDPAK
[roundness/cylindricity evaluation program]

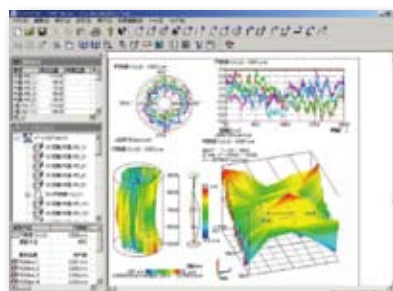

MeasurLink
[measurement data network system]

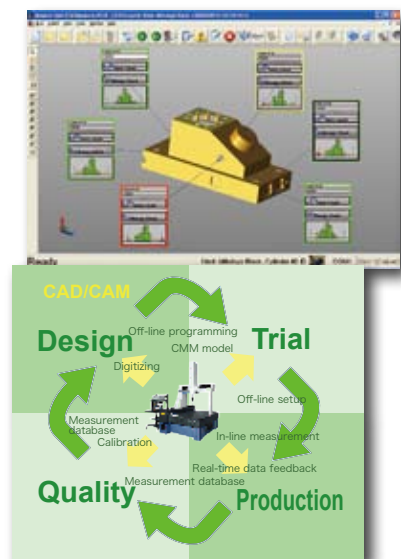

PROBES

— Acquisition of Measurement Data with Interchangeable Sensors —

A major influence on the speed of a CMM is the type of probe used. The first CMMs used what are known as “hard-probes”, which are rigidly fixed solid steel shafts with a cylinder-, cone- or ball-end mounted on the end of the ram, forming a contact point, which is carefully brought into contact with the workpiece at points decided by the operator, at which time the XYZ scale readings on the CMM axes are simultaneously recorded by the operator pressing a foot switch. A data processing unit then performs the simple calculations required to determine the actual coordinates of the surfaces at the points probed. This type of probe, although now obsolescent, still finds use in certain applications on manual CMMs.

In time, alternate types of probe which automatically signal contact between the probe and workpiece were developed so the operator was freed from the task of pressing a footswitch. One variation of the hard probe used electrodes attached to the stylus and workpiece to generate a touch signal by the closing

of the electrical circuit that was formed immediately upon contact of the probe and a conductive workpiece.

However, it was the Touchtrigger Probe launched by Renishaw plc in England that enjoyed explosive popularity and pointed the way to the future. This probe was composed of two elements: a small and light stylus that carried a small contact point on the end, and a probe body that supported the stylus by a spring-loaded kinematic mounting and which was itself rigidly attached to the ram. On contact with a workpiece the stylus was lifted off its mounting which broke an electrical circuit and generated a trigger signal. This was an epoch-making probe that was palm-sized, had high-repeatability and would not scratch a workpiece, but the key attribute it introduced was its “resilience” due to the spring-loading of the contacting element. This meant that the moving elements of the CMM did not have to stop immediately the probe contacted a workpiece, but could travel a small distance afterwards to allow smooth

MPP-310Q



SurfaceMeasure



QVP



and controllable deceleration. It was soon realized that this made possible the development of CMMs operating under automatic powered control. In time, with the advent of the microprocessor, practical CNC operation of the CMM followed. As CMM development shifted from the manual to the CNC type, an automatic rotary head made its debut to meet the need to change probe orientation within a measuring cycle without human intervention. This gave an impetus to the proliferation of the CNC CMM. Recently, various new types of sensor have been developed. For example, high accuracy, scanning, non-contact and so on.

If a commercial probe is not available for a specific use, Mitutoyo develops a dedicated sensor. For example, the detachable scanning probe and vision probe, both launched by Mitutoyo, are among the world's first sensors of their type. And the effective-thread-depth probe and ultra-small contact point probe are sensors far ahead of all others of their type

on the market. Mitutoyo has also succeeded with in-house manufacture of non-contact laser probes that were unopposed on the market and, moreover, Mitutoyo was the first to lower the price of a laser probe, up till then more expensive than that of the CMM itself, to an affordable level.

Even when attempting to develop a new probe we will surely fail unless we are familiar with the control technology for operating it and have the ability to develop analysis software. Mitutoyo has the motto "Create key technologies in house" as one of its business policies. In order to achieve a ground-breaking solution, it is clearly advantageous to be familiar with technologies in as many fields as possible. If any one of those technologies depends on another company, an ideal new product will not be born. Mitutoyo is always ready to develop a solution for a new application.

SURFTEST PROBE



REVO



PH20



Automatic Probe Changer

Peripheral equipment

— Requirements for Providing the Highest Performance —

Upon installation of a CMM in a facility, various types of peripheral equipment are required depending on the model and application. Mitutoyo would like to offer suggestions to meet the intended applications of all customers by making use of its accumulated experience. If an ultra-high-accuracy CMM is due to be introduced, a high-level temperature-controlled

room needs to be prepared. Also, if a general-purpose CMM is installed in a production area in preparation for enabling quicker inspection, a proper inspection room needs to be set up. Mitutoyo is ready to cooperate with suppliers having the experience necessary to meet the above requirements and a track record of offering suggestions for them.

Carrier device



Jig Pallet Manual Carrier System JIGDAS (TRESA Corporation)

Seismic isolation system



(THK CO., LTD)

A CMM which uses the factory air supply should also be supplied with an air dryer (air-server) for top performance. Recently, there have been growing instances where a CMM has been installed in-line. In this case, Mitutoyo can make an optimal proposal for what to do to transport a workpiece, which jigs or fixtures are needed as well as other peripheral equipment to support the measuring machine's operation. We never have the idea that our relationship with a customer

will end with the sale of a measuring machine but are always thinking about how to contribute to the customer's manufacturing efficiency and what is the optimal proposal for that purpose. Occasionally, we may suggest the introduction of a product other than ours. Whenever you face a problem feel free to consult with Mitutoyo and by all means make use of our extensive experience in metrological applications.

Inspection room



Rotary table MRT320



Clamping tools

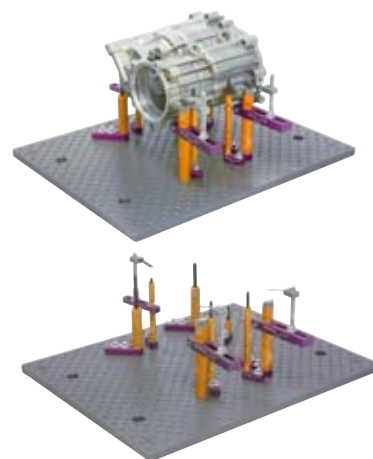

Air-server



(For LEGEX)

Assessment of CMMs to ISO Standards

Performance Assessment Method of Coordinate Measuring Machines

Regarding the performance assessment method of the CMM, a revision of the ISO 10360 series was issued in 2003, and was partially revised in 2009. The following describes the standard inspection method including the revised content.

Table 1 ISO 10360 series

Item	ISO Standard No.	Year of issue
1 Terms	ISO 10360-1:2000	2002
2 Length measurement*	ISO 10360-2:2001	2001
3 Rotary table equipped CMM	ISO 10360-3:2000	2000
4 Scanning measurement	ISO 10360-4:2000	2000
5 Single/Multi-styli measurement**	ISO 10360-5:2002	2002
6 Software inspection	ISO 10360-6:2001	2001

* Revised in 2009 **Revised in 2010

Maximum permissible length measurement error $E_{0,MPE}$ [ISO 10360-2:2009]

Using the standard CMM with specified probe, measure 5 different calibrated lengths 3 times each in 7 directions within the measuring volume (as indicated in Figure 1), making a total of 105 measurements. If these measurement results, including the allowance for the uncertainty of measurement, are equal to or less than the values specified by the manufacturer, then it proves that the performance of the CMM meets its specification.

The result of OK/NG is required to be judged considering the uncertainties.

The maximum permissible error (standard value) of the test may be expressed in any of the following three forms (unit: μm).

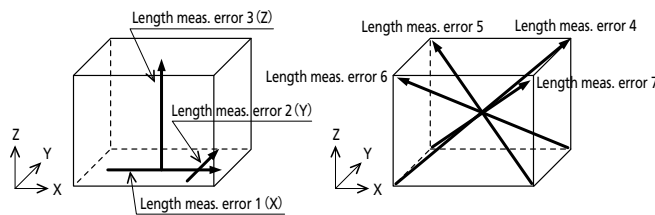

Figure 1 Measuring directions to obtain length measurement error

$$E_{0,MPE} (MPE_e) = A + L/K \leq B$$

$$E_{0,MPE} (MPE_e) = A + L/K$$

$$E_{0,MPE} (MPE_e) = B$$

A: Constant (μm) specified by the manufacturer
 K: Dimensionless constant specified by the manufacturer
 L: Measured length (mm)
 B: Upper limit value (μm) specified by the manufacturer

* ISO 10360-2:2009 specifies measurement in 4 different directions as essential and recommends measurement parallel to each axis, while ISO 10360-2:2001 specified the measurement "in arbitrary 7 directions."

The following error definitions were added in ISO 10360-2:2009.

Maximum Permissible Length Measurement Error / Length Measurement Error when Z-axis stylus offset is 150mm $E_{150,MPE}$ [ISO 10360-2:2009]

In addition to length measurement in 7 directions, ISO 10360-2:2009 specifies measuring in 2 lines over the diagonal YZ or XZ plane with probe offset.

Note: The stylus offset is set at 150mm as default.

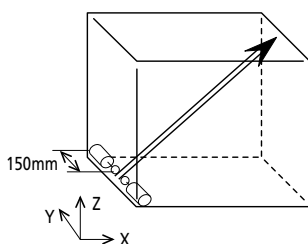

Figure 2 Length measurement error when Z-axis stylus offset is 150mm

Maximum Permissible Limit in Repetitive Length Measurements R_0 , MPL [ISO 10360-2:2009]

Maximum Permissible Limit in Repetitive Length Measurements R_0 , MPL [ISO 10360-2:2009]

After measuring the given length 3 times, evaluate variation in measurement results. Then, calculate the repeatability range R_0 .

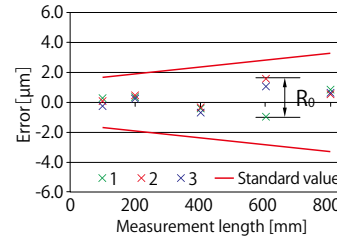

Figure 3 Repeating range of length measurement

Maximum Permissible Rotation Axis Radial-Direction Error MPE_{FR} , Maximum Permissible Rotation Axis Connecting-Direction Error MPE_{FT} , and Maximum Permissible Rotation Axis Axial-Direction Error MPE_{FA} [ISO 10360-3:2000]

The test procedure under this standard is to place two standard spheres on the rotary table as shown in Figure 4. Rotate the rotary table to a total of 15 positions including 0° , 7 positions in the plus (+) direction, and 7 positions in the minus (-) direction and measure the center coordinates of the two spheres in each position.

Then, add the uncertainty of the standard sphere shape to each variation (range) of radial direction elements, connecting direction elements, and rotational axis direction elements of the two standard sphere center coordinates. If these calculated values are less than the specified values, the evaluation test is passed.

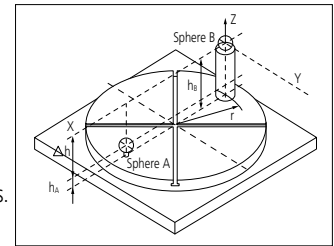

Figure 4 Evaluation of a CMM with a rotary table

Maximum Permissible Scanning Probing Error MPE_{THP} [ISO 10360-4:2000]

This is the accuracy standard for a CMM if equipped with a scanning probe.

Scanning probing error was standardized in ISO 10360-2:2009 for the first time. The test procedure under this standard is to perform a scanning measurement of 4 planes on the standard sphere and then, for the least squares sphere center calculated using all the measurement points, calculate the range (dimension 'A' in Figure 3) in which all measurement points exist. Based on the least squares sphere center calculated above, calculate the distance between the calibrated standard sphere radius and the maximum measurement point or minimum measurement point, and take the larger distance (dimension 'B' in Figure 3). Add an extended uncertainty that combines the uncertainty of the stylus tip shape and the uncertainty of the standard test sphere shape to each A and B dimension. If both calculated values are less than the specified values, this scanning probe test is passed.

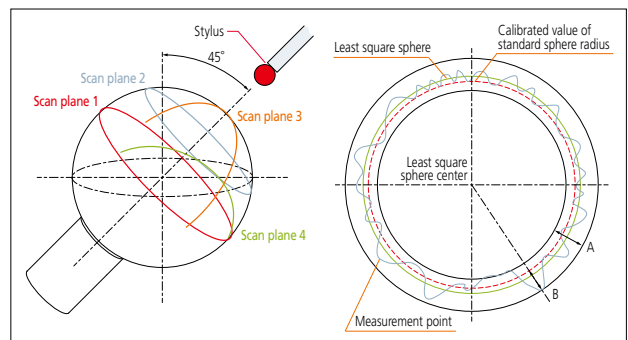

Figure 3 Target measurement planes for the maximum permissible scanning probing error and its evaluation concept

Maximum Permissible Single Stylus Form Error PFTU, MPE [ISO 10360-5:2010]

This measurement was included in the dimensional measurement in ISO 10360-2:2009. However, it is specified as "CMMs using single and multiple stylus contacting probing systems" in ISO 10360-5:2010.

The measurement procedure has not been changed, and the following should be performed.

Measure the defined target points on a standard sphere (25 points, as in Figure 6) and use all the results to calculate the center position of the sphere by a least squares method.

Then, calculate the distance R from the center position of the sphere by a least squares method for each of the 25 measurement points, and obtain the radius difference $R_{max} - R_{min}$. If the radius difference, to which a compound uncertainty of forms of the stylus tip and the standard test sphere are added, is equal to or less than the specified value, it can be judged that the probe has passed the test.

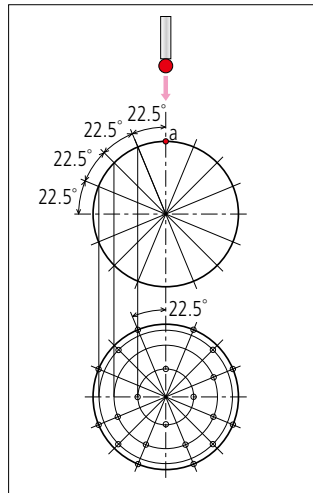

Figure 2 Target points for determining the Maximum Permissible Probing Error

Measurement Uncertainty of CMM

Measurement uncertainty is an indication used for evaluating reliability of measurement results.

In ISO 14253-1:2013, it is proposed to consider the uncertainty when evaluating the measurement result in reference to the specification. However, it is not easy to estimate the uncertainty of the measurement performed by a CMM.

To estimate the uncertainty of the measurement, it is necessary to quantify each source of the uncertainty, and determine how it propagates to the measurement result. The CMM is capable of having all types of settings that determine how the measurement should be performed, such as measurement point distribution, or datum definition, according to the drawing instruction or operator's intention. This feature makes it harder to detect the source of uncertainty influencing the result. Taking the circle measurement as an example, just a difference of one measurement point and its distribution causes the necessity of recalculation of the uncertainty.

Also, there are many sources of uncertainty to be considered with the CMM and their interactions are complicated.

Because of the above, it is almost impossible to generalize on how to estimate measurement uncertainty of the CMM.

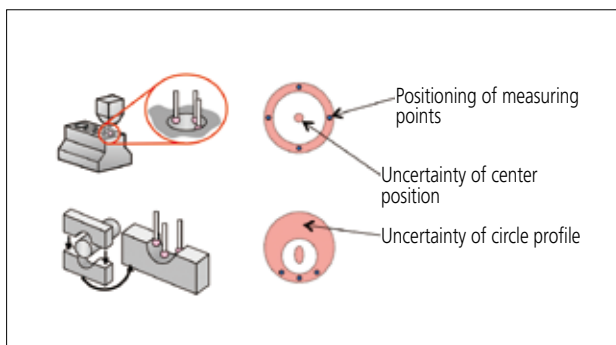

Example of circle measurement by CMM

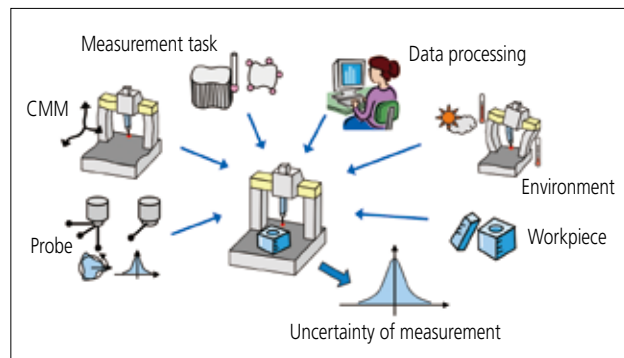

Major contributions that cause measurement uncertainty of the CMM

Measurement uncertainty of the CMM and the Virtual CMM software

The Virtual CMM software enables estimation of complicated measurement uncertainty of a CMM. The software simulates a CMM on a PC based on its machine characteristics and performs virtual (simulated) measurements. The simulated measurements are performed according to the part program created by the operator. The machine characteristics are evaluated from experimental values based on geometrical characteristics of the actual machine, probing characteristics, and temperature environment, etc. The measurement uncertainty of the CMM can be easily estimated by using the Virtual CMM software package.

ISO15530 Part 4 (ISO/TS 15530-4(2008)) defines how to verify the validity of task-specific measurement uncertainty using computer simulations. Virtual CMM conforms to this specification.

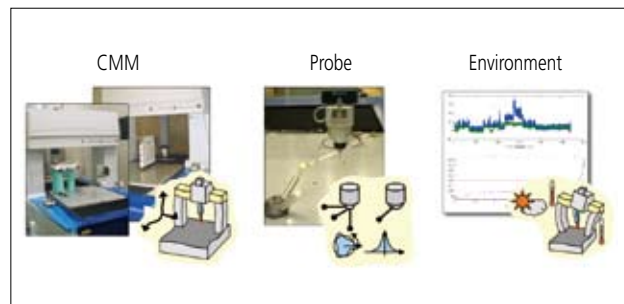

Quantification of CMM uncertainty elements by experiment

Note: Virtual CMM is a software package originally developed by PTB (Physikalisch-Technische Bundesanstalt).

Relevant parts of ISO15530: Geometrical Product Specifications (GPS) – Coordinate measuring machines (CMM): Technique for determining the uncertainty of measurement –

Part 3: Use of calibrated workpieces or measurement standards

Part 4: Evaluating task-specific measurement uncertainty using simulation [Technical Specification]

Maximizing CMM Performance

Operation of the CMM has been simplified for making complicated measurements through the evolution of software and the Graphical User Interface (GUI). Even so, since a CMM is relatively complex, being comprised of a probe and software in addition to the main unit, it is true that detailed knowhow is needed to attain highly reliable measurement data. Depending on whether you have this knowhow or not, measurement results may be unreliable to the extent that an acceptable product is rejected as NG and a NG product is accepted, which may well have a significantly negative impact on your company. The following introduces precautions to be taken to maximize CMM performance to avoid this situation.

Preparation

1. Selection of an appropriate stylus
 - (a) Select an appropriate contact point size.
 - The smaller the diameter, the larger the influence of surface texture (such as roughness or scratches) will be on measurement accuracy..
 - (b) Select an appropriate contact point material
 - An aluminum alloy part should not be measured with a ruby contact point as this alloy will adhere to the ruby (causing material pickup), marring the workpiece surface and reducing measurement accuracy. Use a stylus with a different contact point material such as tungsten carbide.
 - (c) Do not use a longer stylus than required
 - Do not allow the stylus stem to contact the workpiece instead of the contact point (known as shanking).
2. Mounting the workpiece on the measuring table
 - (a) A workpiece shall not be movable by the measuring force applied by the contact point.
 - (b) Do not mount a workpiece so that it may be deformed
 - The most common cause of this is by applying large clamping forces to thin, unsupported sections of a workpiece. Also, a long and thin part may deform under its own weight, so should be supported in a manner as close as possible to that experienced when in service.

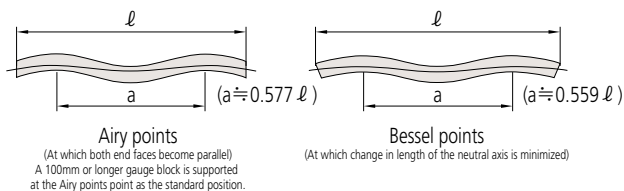

- c) Fix a workpiece so as to prevent deformation (such as twist) due to temperature variation.

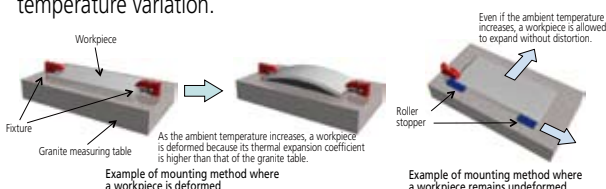

- (d) Firmly mount the reference sphere, probe and stylus without looseness.

3. Cleaning

If dirt and dust adhere to the reference sphere, probe, stylus or workpiece, measurement accuracy may be adversely affected more than supposed. Be sure to properly clean them before measurement. In this case, do not use organic solvent such as alcohol. Otherwise the adhesive joining the contact point to the stylus stem may be dissolved.

Performing measurement

1. Precautions to be taken for data point entry
 - (a) Data points capture and approach direction of the stylus
 - Positively touch the contact point on each target point.
 - The stylus should approach the target surface as close as possible to the normal direction (to prevent the contact point slipping sideways away from the target point).
 - (b) Distribution of data points
 - Taking data points from the widest possible length or area over a feature ensures the highest accuracy. (For example, probe points all around the periphery of a hole, not close together. See below.)

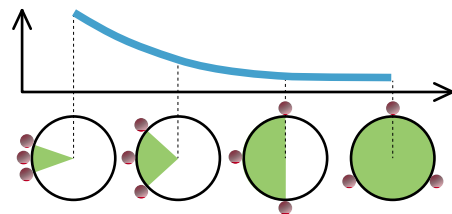

- (c) Number of probed points
 - In order to reduce the influence of the touch-trigger probe's orientation and any outlier points due to dirt and dust, it is desirable to increase the number of data points. However, there is an optimum number of points and this is a compromise between efficiency and accuracy.

2. Coping with drawing instructions that make measurement difficult

- (a) A short reference feature
 - A short measuring length as in the following figure will enlarge measurement error. In this case, evaluate the reference portion with reference to the evaluating portion (in consultation with the customer, see below).

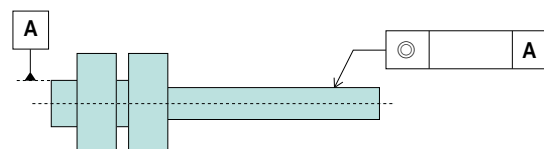

(b) Only a small part of feature is allowed to be measured

- If circle measurement is performed at each portion of R4,500 and R5,500 in the figure below, an excessive error will result. It is more reliable to evaluate whether measurement points are within tolerance by providing a nominal curve for the segment to be measured.

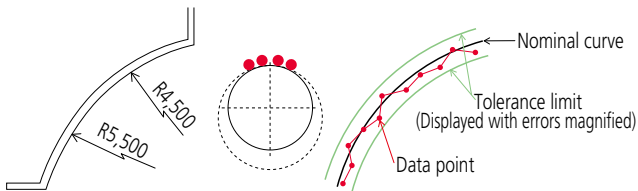

(c) For a virtual reference line

- In the case of the figure below, it is not possible to correctly set the reference for measurement. It is optimal to minimize measurement error using the best-fit function while creating a temporary reference by use of circle 1, and with circle 2 undefined as the reference.

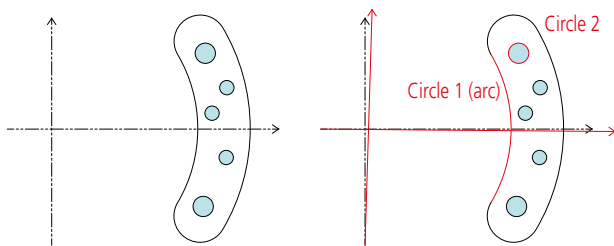

(d) Tapped hole position

- If a tapped hole position is measured with normal circle measurement, its center position will not be stable. Consequently, the hole axis is located by inserting a screwed plug or pin gage. However, this method is time consuming and becomes an error factor as well due to the unavoidable clearance between the hole and gage. The use of the tapped hole macro function to perform cylinder measurement in a spiral fashion allows high-accuracy direct measurement of tapped holes.

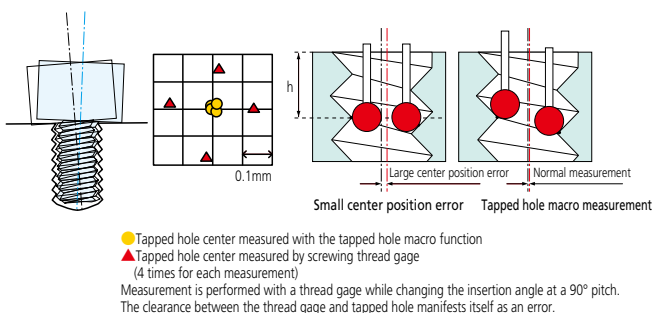

About Data Consistency

In order that a product that has been delivered with CMM measurement data attached will not be returned as NG from a customer having a CMM, it is important to discuss the measuring method with the customer beforehand and that you both agree to:

- (1) Confirm whether it is best to use a CMM or another measuring machine.
- (2) Use the same diameter and length of stylus.
- (3) Mount the product in the same position and with the same clamping force.
- (4) Confirm whether it is acceptable to correct the product form by clamping.
- (5) Firmly mount even a heavy product.
- (6) Use the same reference position for measurement.
- (7) Use the same data entry points and the same number of measuring points.
- (8) Use the same calculation method (mean circle or inscribed circle for circle measurement).
- (9) Use the same substitute method in the case of a difficult measurement.
- (10) Confirm the measurement environments (such as ambient temperature).

Daily Maintenance

A measuring machine is the last link in the chain that assures manufacturing quality, and will sustain the credibility of a manufacturer if it is in efficient working order. It is extremely important to always maintain the high performance of a CMM by performing proper maintenance.

[Routine check items]

- (1) Supplied air pressure [Daily]
- (2) Air filter, mist separator: Check for accumulation of water/oil [daily], and replace elements yearly.
 If moisture or fine dust and dirt adheres to a guideway surface, wipe it off with a soft, lint-free cloth or paper. If stains, such as caused by oil, are not removed, use a volatile solvent (dehydrated alcohol, etc.). [Daily]
- (3) Cleaning of each guideway.
 Wipe off stains with a dry, soft cloth, or with a dedicated cleaner or alcohol-moistened cloth. Absolutely do not use water or oil because it will expand the granite. [Occasionally]
- (4) Measuring table (granite)
 Wipe off stains with a dry, soft cloth, or with a dedicated cleaner or alcohol-moistened cloth. Absolutely do not use water or oil because it will expand the granite. [Occasionally]
- (5) Each axis scale
 Any dirt on the scale will cause miscounting. If oil, including oil mist, adheres to the scale, wipe it off with an alcohol-moistened cloth. [Occasionally]
- (6) Air filter on the control unit
 Clean or replace the air filter depending on the rate of contamination.

Domestic Network

Providing the highest quality services is our mission. In order to support a broad range of customer needs, Mitutoyo is strengthening its network to enable support to be provided even more quickly and effectively. We are expanding our circle of trust with customers through our integrated service system, which ranges from consultations and proposals to after-sales support.



Sendai Sales Office



Utsunomiya Sales Office



Suwa Sales Office



Osaka Sales Office



Fukuoka Sales Office



- Sales
- Service Center
- Calibration Center
- M³ Solution Center

Sales

Sendai Sales Office
TEL (022) 231-6881 FAX (022) 231-6884
Kooriyama Resident Office TEL (024) 931-4331

Utsunomiya Sales Office
TEL (028) 660-6240 FAX (028) 660-6248
Tsukuba Resident Office TEL (029) 839-9139

Isesaki Sales Office
TEL (0270) 21-5471 FAX (0270) 21-5613
Niigata Resident Office TEL (025) 281-4360
Saitama Resident Office TEL (048) 667-1431

Kawasaki Sales Office
TEL (044) 813-1611 FAX (044) 813-1610
Tokyo Resident Office TEL (03) 3452-0481

Atsugi Sales Office
TEL (046) 226-1020 FAX (046) 229-5450
Fuji Resident Office TEL (0545) 55-1677

Suwa Sales Office
TEL (0266) 53-6414 FAX (0266) 58-1830
Ueda Resident Office TEL (0268) 26-4531

Hamamatsu Sales Office
TEL (053) 464-1451 FAX (053) 464-1683

Anjo Sales Office
TEL (0566) 98-7070 FAX (0566) 98-6761

Nagoya Sales Office
TEL (052) 741-0382 FAX (052) 733-0921

Kanazawa Sales Office
TEL (076) 222-1160 FAX (076) 222-1161

Osaka Sales Office
TEL (06) 6613-8801 FAX (06) 6613-8817
Kobe Resident Office TEL (078) 924-4560

Keiji Sales Office
TEL (077) 569-4171 FAX (077) 569-4172

Okayama Sales Office
TEL (086) 242-5625 FAX (086) 242-5653

Hiroshima Sales Office
TEL (082) 427-1161 FAX (082) 427-1163

Fukuoka Sales Office
TEL (092) 411-2911 FAX (092) 473-1470

Service Centers

Techno-Service Business Division
TEL (044) 813-8213 FAX (044) 822-4136

Utsunomiya Service Center
TEL (028) 660-6280 FAX (028) 660-6257

Yokohama Service Center
TEL (045) 938-5718 FAX (045) 938-5721

Suwa Service Center
TEL (0266)53-5495 FAX (0266)58-1830

Nagoya Service Center
TEL (052) 731-7100 FAX (052) 731-6110

Anjo Service Center
TEL (0566) 96-0745 FAX (0566) 96-0747

Osaka Service Center
TEL (06) 6613-8813 FAX (06) 6613-8818

Hiroshima Service Center
TEL (082) 427-1164 FAX (082) 427-1163

Fukuoka Service Center
TEL (092) 411-2909 FAX (092) 482-7894

Seismic monitoring system Service Section
Testing machine Service Section
TEL (045) 938-5718 FAX (045) 938-5721

Overseas Service Support Section
TEL (044) 813-8247 FAX (044) 822-4136

Calibration Centers

Utsunomiya Measurement Standards Calibration Center
TEL (028) 656-1432 FAX (028) 656-8443

Kawasaki Calibration Center
TEL (044) 813-8214 FAX (044) 813-8223

Hiroshima Calibration Center
TEL (0823) 70-3820 FAX (0823) 70-3833

M³ Solution Centers
UTSUNOMIYA
TEL (028) 660-6240 FAX (028) 660-6248

TOKYO
TEL (044) 813-1611 FAX (044) 813-1610

SUWA
TEL (0266) 53-6414 FAX (0266) 58-1830

ANJO
TEL (0566) 98-7070 FAX (0566) 98-6761

OSAKA
TEL (06) 6613-8801 FAX (06) 6613-8817

HIROSHIMA
Please contact to M³ Solution Center FUKUOKA.
Or Please contact to Hiroshima Sales Office.

FUKUOKA
TEL (092) 411-2911 FAX (092) 473-1470

Global Network

Following the establishment of MTI Corporation (U.S.) in 1963, Mitutoyo has been expanding its market throughout the world. Currently, the company has R&D, manufacturing, sales, and engineering service bases in 31 countries, as well as a network of distributors in some 83 countries. Mitutoyo maintains its rock solid status as a leading global manufacturer providing services tailored to each regional society.



Mitutoyo Europe GmbH



Mitutoyo (UK) Ltd.



Mitutoyo France S.A.R.L.



Mitutoyo America Corporation Head Office



Mitutoyo Italiana S.R.L.



Mitutoyo Asia Pacific Pte. Ltd. Regional Headquarters

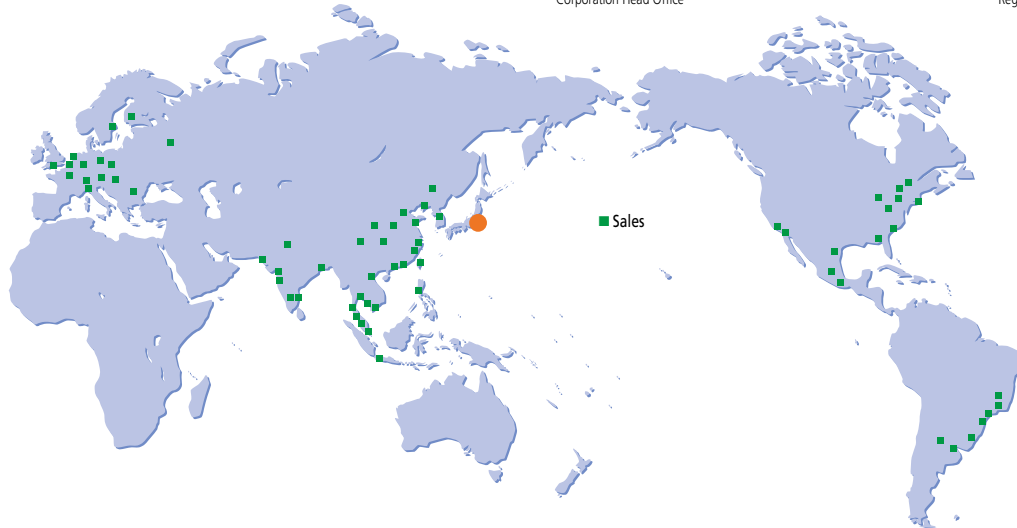

Europe

Europe

- Mitutoyo Europe GmbH
Neuss, GERMANY
- Germany
Mitutoyo Deutschland GmbH
Neuss, GERMANY
- M³ Solution Center Hamburg
Hamburg, GERMANY
- M³ Solution Center Berlin
Berlin, GERMANY
- M³ Solution Center Eisenach
Eisenach, GERMANY
- M³ Solution Center Ingolstadt
Ingolstadt, GERMANY
- M³ Solution Center Leonberg
Leonberg, GERMANY
- Mitutoyo-Messgeräte Leonberg GmbH
Leonberg, GERMANY

U.K.

- Mitutoyo (UK) Ltd.
Hampshire UNITED KINGDOM
- M³ Solution Center Coventry
Warwickshire, UNITED KINGDOM
- M³ Solution Center Halifax
West Yorkshire, UNITED KINGDOM
- M³ Solution Center East Kilbride
East Kilbride, UNITED KINGDOM

France

- Mitutoyo France
Paris, FRANCE
- M³ Solution Center LYON
Saint-Priest Cedex, FRANCE
- M³ Solution Center STRASBOURG
Géispolsheim, FRANCE
- M³ Solution Center CLUSES
Scionzier, FRANCE
- M³ Solution Center TOULOUSE
TOULOUSE, FRANCE

Italy

- Mitutoyo ITALIANA S.r.l.
Corso Europa, ITALY
- M³ Solution Center TORINO
Volpiano (TO), ITALY
- M³ Solution Center CHIETI
Rocca S. Giovanni (CH), ITALY

Netherlands

- Mitutoyo Nederland B.V.
KX Veenendaal, THE NETHERLANDS

Belgium

- Mitutoyo Belgium N.V.
Kruibeke, BELGIUM

Sweden

- Mitutoyo Scandinavia AB
Upplands Väsby, SWEDEN
- M³ Solution Center Alingsas
Alingsas, SWEDEN
- M³ Solution Center Värnamo
Värnamo, SWEDEN

Finland

- Mitutoyo Scandinavia Aktiebolag Finnish Branch
Pirkkala, FINLAND

Switzerland

- Mitutoyo Schweiz AG
Urdorf, SWITZERLAND

Poland

- Mitutoyo Polska Sp.z o.o.
Wroclaw, POLAND

Czech Republic

- Mitutoyo Cesko, s.r.o.
Teplice, CZECH REP

Hungary

- Mitutoyo Hungária Kft.
Budapest, HUNGARY

Romania

- Mitutoyo Romania SRL
OTOPENI-ILFOV, ROMANIA

Russian Federation

- Mitutoyo RUS LLC
Moscow, RUSSIAN FEDERATION

Austria

- Mitutoyo Austria GmbH
Traun, AUSTRIA

Southeast and South Asia

Singapore

- Mitutoyo Asia Pacific Pte. Ltd.
Head Office / M³ Solution Center
SINGAPORE

Malaysia

- Mitutoyo (Malaysia) Sdn. Bhd.
Kuala Lumpur Head Office / M³ Solution Center
Selangor, MALAYSIA
- Penang Branch office / M³ Solution Center
Penang, MALAYSIA
- Johor Branch office / M³ Solution Center
Johor, MALAYSIA

Indonesia

- PT. Mitutoyo Indonesia
Head Office / M³ Solution Center
Bekasi, INDONESIA

Thailand

- Mitutoyo (Thailand) Co., Ltd.
Bangkok Head Office / M³ Solution Center
Bangkok, THAILAND
- Cholburi Branch / M³ Solution Center
Cholburi, THAILAND
- Amata Nakorn Branch / M³ Solution Center
Cholburi, THAILAND

Vietnam

- Mitutoyo Vietnam Co., Ltd.
Hanoi Head Office / M³ Solution Center
Hanoi, VIETNAM
- Ho Chi Minh City Branch Office / M³ Solution Center
Ho Chi Minh City, VIETNAM

Philippines

- Mitutoyo Philippines, Inc.
Laguna, PHILIPPINES

India

- Mitutoyo South Asia Pvt. Ltd.
Head Office / M³ Solution Center
New Delhi, INDIA

East Asia

- MSA Gurgaon technical center Gurgaon, INDIA
- Mumbai Region Head office
Mumbai, INDIA

Pune Office / M³ Solution Center

- Pune, INDIA
- Vadodara office
Vadodara, INDIA
- Bengaluru Region Head office / M³ Solution Center
Bengaluru, INDIA
- Chennai Office / M³ Solution Center
Chennai, INDIA
- Kolkata Office
Kolkata, INDIA

East Asia

Taiwan

- Mitutoyo Taiwan Co., Ltd. / M³ Solution Center
Taipei
Taipei City TAIWAN (R.O.C.)
- Taichung Branch / M³ Solution Center Taichung
Taichung City, TAIWAN(R.O.C.)
- Kaohsiung Branch / M³ Solution Center
Kaohsiung
Kaohsiung City, TAIWAN(R.O.C.)

South Korea

- Mitutoyo Korea Corporation
Head Office / M³ Solution Center
Gyeonggi-do, KOREA
- Busan Office / M³ Solution Center
Busan, KOREA
- Daegu Office / M³ Solution Center
Daegu, KOREA

China

- Mitutoyo Measuring Instruments (Shanghai) Co., Ltd.
Shanghai, CHINA
- Suzhou Office / M³ Solution Center China (Suzhou)
Suzhou, CHINA
- Wuhan Office
Wuhan, CHINA
- Chengdu Office
Sichuan, CHINA
- Hangzhou Office
Hangzhou, CHINA
- Tianjin Office / M³ Solution Center Tianjin
Tianjin, CHINA
- Changchun Office
Changchun, CHINA
- Qingdao Office / M³ Solution Center Qingdao
Shandong, CHINA
- Xi'an Office
Xi'an, CHINA
- Dalian Office / M³ Solution Center Dalian
Dalian, CHINA
- Zhengzhou Office
District,Zhengzhou City, CHINA
- Mitutoyo Leeport Metrology (Hong Kong) Limited
Kwai Chung, NT, HONG KONG
- Mitutoyo Leeport Metrology (Dongguan) Limited / M³ Solution Center Dongguan
Guang Chang Road, Chong Tou Zone
Shandong, CHINA
- Mitutoyo Leeport Metrology (Dongguan) Limited - Fuzhou office
Fuzhou City, CHINA
- Mitutoyo Leeport Metrology (Dongguan) Limited - Changsha office
Hunan Province, CHINA

Americas

U.S.A.

- Mitutoyo America Corporation
Aurora, U.S.A.
- M³ Solution Center-Illinois
Aurora, U.S.A.
- M³ Solution Center-Ohio
Mason, U.S.A.
- M³ Solution Center-Michigan
Plymouth, U.S.A.
- M³ Solution Center-California
City of Industry, U.S.A.
- M³ Solution Center-North Carolina
Huntersville, U.S.A.
- M³ Solution Center-Alabama
Hoover, U.S.A.
- M³ Solution Center-Massachusetts
Marlborough, USA
- M³ Solution Center-Washington
Renton, U.S.A.
- M³ Solution Center-Texas
Houston, U.S.A.

Canada

- Mitutoyo Canada Inc.
Mississauga, Ont. L5N 5N1., CANADA
- Montreal Office
Quebec, CANADA

Argentina

- Mitutoyo Sul Americana Ltda.
Argentina Branch
Buenos Aires - ARGENTINA
- Sucursal Cordoba
Cordoba, ARGENTINA

Mexico

- Mitutoyo Mexicana S. A. de C. V.
Estado de México, MEXICO
- Monterrey Office / M³ Solution Center
Guadalupe, MEXICO
- Tijuana Office / M³ Solution Center
Tijuana, MEXICO
- Querétaro Office / M³ Solution Center
Fraccionamiento Observatorio
- AguaCalientes Office / M³ Solution Center
AguaCalientes Aqs, MEXICO
- Irapuato Office / M³ Solution Center Irapuato
Irapuato, Gto., MEXICO

Brazil

- Mitutoyo Sul Americana Ltda.
São Paulo - SP, BRASIL
- Regional Office
Belo Horizonte - MG
- Rio Grande do Sul / PR, SC
- Rio de Janeiro - RJ
- Santa Barbara D'Oeste - SP
- Norte, Nordeste, Centro Oeste



Whatever your challenges are, Mitutoyo supports you from start to finish.

Mitutoyo is not only a manufacturer of top quality measuring products but one that also offers qualified support for the lifetime of the equipment, backed up by comprehensive services that ensure your staff can make the very best use of the investment.

Apart from the basics of calibration and repair, Mitutoyo offers product and metrology training, as well as IT support for the sophisticated software used in modern measuring technology. We can also design, build, test and deliver bespoke measuring solutions and even, if deemed cost-effective, take your critical measurement challenges in-house on a sub-contract basis.



Find additional product literature and our product catalogue

<http://www.mitutoyo.co.jp/global.html>

Our products are classified as regulated items under Japanese Foreign Exchange and Foreign Trade Law. Please consult us in advance if you wish to export our products to any other country. If the purchased product is exported, even though it is not a regulated item (Catch-All controls item), the customer service available for that product may be affected. If you have any questions, please consult your local Mitutoyo sales office.

Note: Product illustrations are without obligation. Product descriptions, in particular any and all technical specifications, are only binding when explicitly agreed upon. MITUTOYO and MICAT are either registered trademarks or trademarks of Mitutoyo Corp. in Japan and/or other countries/regions. Other product, company and brand names mentioned herein are for identification purposes only and may be the trademarks of their respective holders.

Mitutoyo

Mitutoyo Corporation

20-1, Sakado 1-Chome,
Takatsu-ku, Kawasaki-shi,
Kanagawa 213-8533, Japan
T +81 (0) 44 813-8230
F +81 (0) 44 813-8231
<http://www.mitutoyo.co.jp>