



# A wide range of probes supports various kinds of your measurement applications

## Probes for Coordinate Measuring Machines

Page 4-33

### Scanning Probes

■ **MPP-310Q**  
Ultra High-Accuracy Scanning

● Page No. ▶ 4, 5



■ **SP80**  
High-accuracy Scanning Probe Can Use Very Long Styli

● Page No. ▶ 6, 7



■ **SP25M**  
Compact High-accuracy Scanning Probe

● Page No. ▶ 8, 9



■ **SP600Q**  
High-accuracy Scanning Probe

● Page No. ▶ 10, 11



### Non-contact Probes

■ **SurfaceMeasure**  
Non-contact Laser Probe

● Page No. ▶ 12, 13



■ **QVP**  
Quick Vision Probe

● Page No. ▶ 14, 15

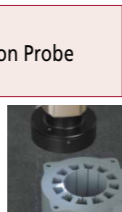

■ **CF20**  
Centering Microscope for Coordinate Measuring Machines

● Page No. ▶ 16, 17



### Special-purpose Probes

■ **SURFTTEST PROBE**  
Surface Roughness Probe

● Page No. ▶ 18, 19



### Touch-trigger Probes

■ **TP7M**  
High-Accuracy Touch-trigger Probe

● Page No. ▶ 20, 21



■ **TP200**  
Compact High-Accuracy Touch-trigger Probe

● Page No. ▶ 22, 23



■ **TP20**  
Compact Touch-trigger Probe

● Page No. ▶ 24, 25



■ **MH20i**  
Touch-trigger Probe with Manual Probe Head

● Page No. ▶ 26, 27



## Probe Heads

■ **PH10M/PH10MQ**  
Motorized Probe Head

● Page No. ▶ 28, 29



Application of the Touch-trigger Probe▶

■ **PH1**  
Manual Probe Head

● Page No. ▶ 30



Application of the Touch-trigger Probe▶

## 5-axis Control System Probes

■ **REVO-2**  
High-speed 5-axis Control Scanning Head

● Page No. ▶ 31



■ **PH20**  
5-axis Control Touch-trigger System

● Page No. ▶ 31



## Probe Changer

■ **ACR3**  
Automatic Probe Changer

● Page No. ▶ 32



## Rotary Tables for CNC CMM

■ **MRT240/MRT320/QS600/800**  
Rotary table

● Page No. ▶ 33

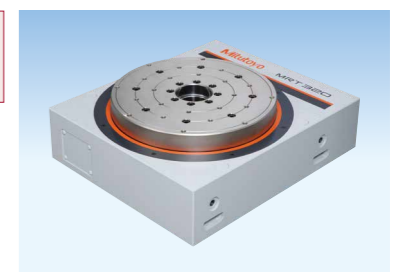

Quick Guide to Styli .....Page 34  
 Product Identification on Styli for Coordinate Measuring Machines .....Page 36  
 Various Styli .....Page 37  
 Attachment Tools.....Page 55  
 Stylus Set .....Page 55  
 Stylus Cleaner .....Page 57  
 Ceramic Master Ball.....Page 58  
 Joystick Box, Safety Laser Scanner.....Page 59

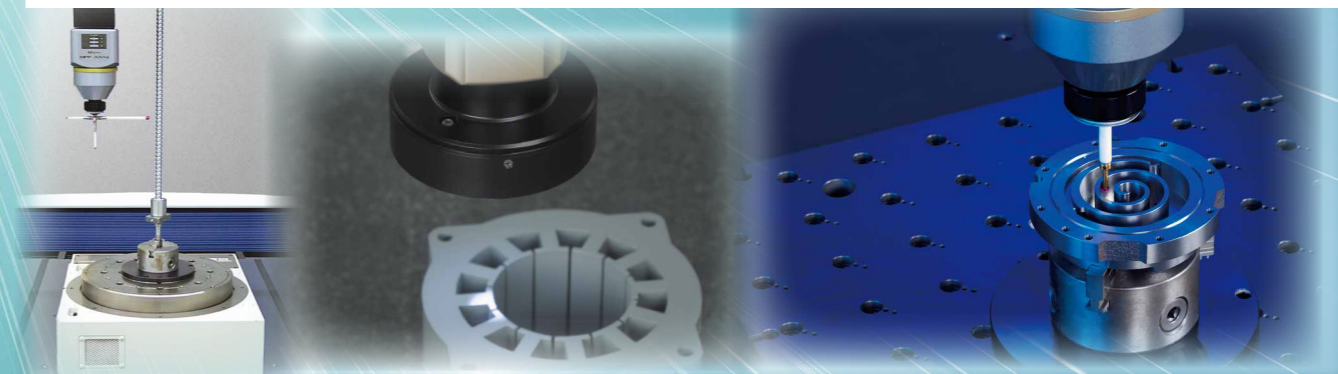

# MPP-310Q Ultra High-Accuracy Scanning



### Fast scanning

The **MPP-310Q** is a multi-functional probe designed for CNC coordinate measuring machines. It can not only perform a continuous path contact-type scanning measurement [a measurement method that implements a collection of a large amount of coordinate data while traveling along a continuous path in contact with the workpiece] at  $V2 \leq 0.3 \mu\text{m}$  (reference value when the LEGEX series is installed), but also high-accuracy point measurement of  $\leq 0.1 \mu\text{m}$  (on the LEGEX CMM series), and data collection from a centering point measurement.

### Omni-directional scanning

The **MPP-310Q** has internal high-accuracy scales with a minimum resolution of  $0.01 \mu\text{m}$  for each direction (X, Y, and Z axes), which makes it possible to read the stylus displacement in any direction.

The air bearing employed in the sliding section of each axis helps enable this probe with minimum directionality.

### Low measuring force

The ordinary touch-trigger probe, even if it needs only a small force to generate a trigger signal the moment the stylus actually comes into contact with the workpiece, may apply several tens to several hundred grams of force in the over-travel period that immediately follows contact. In addition, some scanning probes from other manufacturers employ such a structure that the motor drive mechanism forcibly determines the probing position in order to permit the use of a longer stylus, necessitating the probe to actually produce a greater measuring force.

In contrast, the **MPP-310Q** can reduce its measuring force to a minimum of  $0.03 \text{ N}$  so that it can even measure elastic workpieces such as resins, etc., without damaging them at all.

### Fast scanning

For a scanning measurement, either of the following scanning methods can be selected: one in which scanning progresses while automatically following an unknown geometry (unknown geometry scanning), or one in which scanning progresses based on the locus of the probe tip given beforehand (known geometry scanning). With known geometry scanning it is possible to perform fast scanning at  $120 \text{ mm/s}$ .

Conventionally, it is normal to evaluate geometries such as a line or a circle through point measurement. However, for evaluating the flatness or roundness of an extra precision-machined workpiece, it is better to improve the reliability of the measurement result by evaluating the object at more measurement points.

Naturally, it takes an extended amount of time for a touch-trigger probe to measure such an object point by point if very many points are involved. In contrast, the **MPP-310Q** can, for example, complete a measurement in just a few seconds even if it is required to measure an inside diameter of  $100 \text{ mm}$  using 1000 measurement points. In addition, measurement can be pursued effectively while changing the scanning speed, depending on the measurement accuracy required.

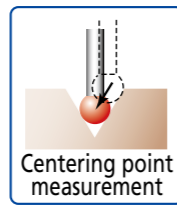

Centering point measurement

### Optional units

A wide variety of optional units, including rotary table for synchronized scanning and the automatic stylus change system, is available.

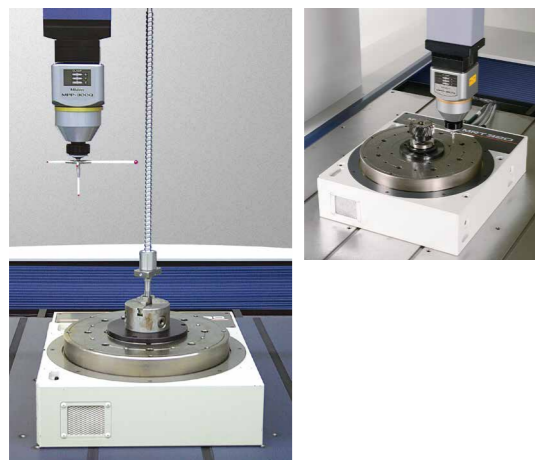

### Dimensions

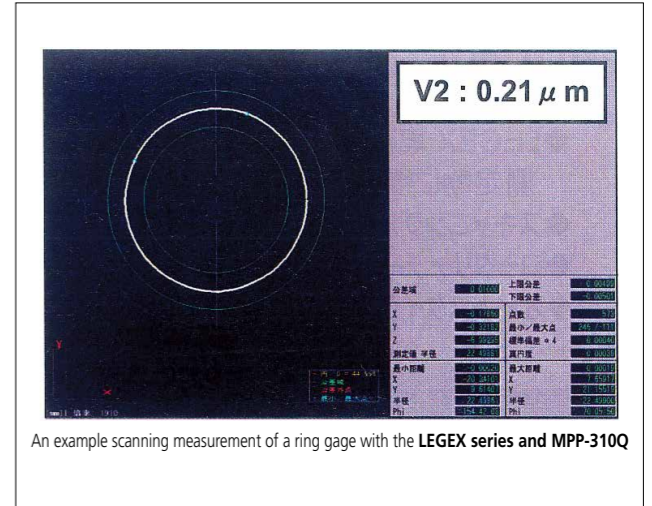
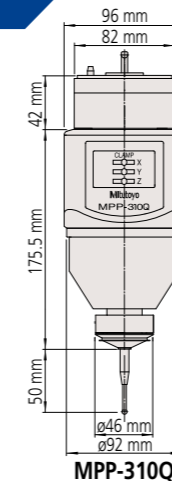

An example scanning measurement of a ring gage with the LEGEX series and MPP-310Q

### Set configuration

Unit	Ref. No.	Description	Qty	Remarks
MPP-310Q(S) Probe set	1	MPP-310Q probe main unit	1	Including one stylus mount assembly
	2	Damping oil	1	Silicon oil (2000CS)
	3	Allen wrench / GXL-20	1	
	4	Allen wrench / GXL-30	1	
	5	Storage box	1	Wooden box for storing MPP-310Q
MPP-310Q System (S)	6	MS4-4R13.5-S	1	
	7	MS4-4R33-S	5	
	8	MS4-EXT30C	2	M4-M4 ceramics Extension L=30 mm
	9	MS4-EXT50C	1	M4-M4 ceramics Extension L=50 mm
	10	MS4-EXT100C	1	M4-M4 ceramics Extension L=100 mm
	11	MS4-stylus knuckle	1	
	12	MS4-stylus center	1	
	13	stylus tool	2	For attaching/detaching M4 stylus
	14	MPP-310Q Hardware Guide	1	English
	15	EXT CONTOUR cable A	1	
	16	EXT CONTOUR short cable	1	
	17	AC cable	1	For overseas specification
	18	MPP-310 Clamp unit	1	Desktop unit

Note: Some items cannot be ordered separately.

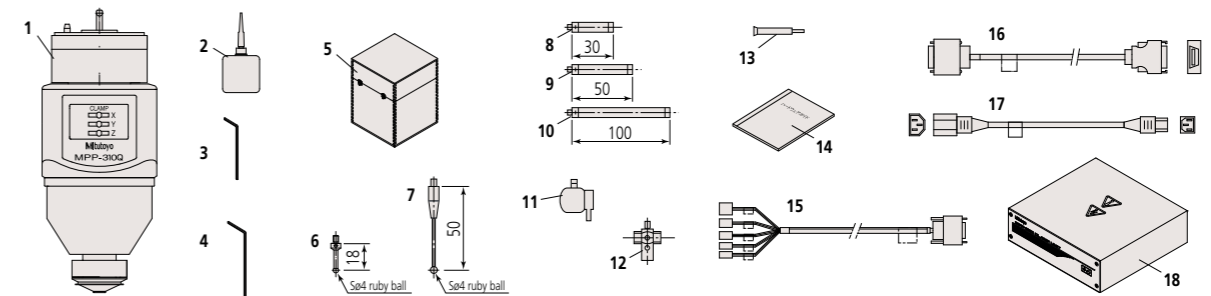

### MPP-310Q Specifications

MPP-310Q	Measuring range	$\pm 1 \text{ mm}$
	Resolution	$0.01 \mu\text{m}$
	Scanning error $MPE_{THP}$ (JIS B 7440-4: 2003)	$1.1 \mu\text{m}$ (60 sec) (LEGEX500/700/900: when the $\phi 4 \times 18 \text{ mm}$ stylus is used.)
	Single stylus shape error $P_{FTU,MPE}$ (JIS B 7440-5: 2013)	$0.4 \mu\text{m}$ (LEGEX500/700/900: when the $\phi 4 \times 18 \text{ mm}$ stylus is used.)
	Spring rate	$0.2 \text{ N/mm}$
	Max. stylus length	$200 \text{ mm}$ for both vertical and horizontal *1
	Max. stylus mass	$75 \text{ g}$ *1
	Stylus mount	M4 thread
	Max. tracing speed	$120 \text{ mm/s}$ [for known geometry scanning]
	Air flow rate	$30 \text{ NL/min}$
	Probe head	N/A
	Applicable models	CNC CMM*2
	Automatic stylus change system (optional)	No. of mountable stylus modules

\*1 Increase in stylus length or stylus mass may reduce accuracy.

\*2 Note that some probes are subjected to the limitation of mounting or unable to mount.

### Optional units Automatic Stylus Changer

#### Dimensions

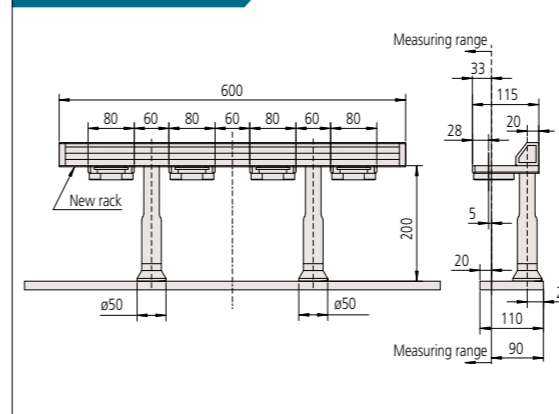

#### Detail

Unit	Ref. No.	Description	Qty	Remarks
Automatic stylus change system	1	Auto-stylus change rack	1	Supplied with 4 ports for replacement.
	2	Stylus mount assembly	3	Used for installing a rack on the CMM base.
	3	Auxiliary plate	1	
	4	MS4-4R13.5-S	3	
	5	MS4-stylus center	3	
	6	Reference sphere	1	For re-calibration

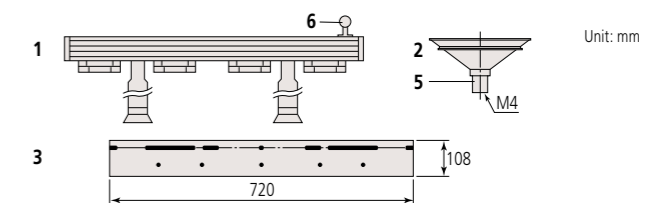

# SP80 High-accuracy Scanning Probe with Long Stylus Carrying Capacity



### High accuracy achieved even with very long styli

The **SP80** scanning probe is designed to achieve high measurement accuracy even when using styli up to 500 mm (in both the horizontal and vertical directions) in length. It is a multi-function probe for CNC coordinate measuring machines that undertakes not only scanning measurement (a measurement method that collects a large amount of coordinate data while traveling along a path in contact with the workpiece) but also high-accuracy point measurement as well as data collection from a centering point measurement.

### Fast scanning

For scanning measurement, either of the following scanning methods can be selected: one in which scanning progresses while automatically following an unknown geometry (unknown geometry scanning), or one in which scanning progresses based on the locus of the probe tip given beforehand (known geometry scanning). With known geometry scanning it is possible to perform fast scanning at 120 mm/s. Conventionally, it is normal to evaluate geometries such as a line or circle through point measurement. However, for evaluating the flatness or roundness of an extra precision-machined workpiece, it is better to improve the reliability of the measurement result by evaluating the object at more measurement points. Naturally, it takes an extended amount of time for a touch-trigger probe to measure such an object point by point. In contrast, the **SP80** can, for example, complete a measurement in just a few seconds, even if it is required to measure an inside diameter of 100 mm using 1000 measurement points. In addition, any measurement can be pursued effectively while changing the scanning speed, depending on the measurement accuracy required.

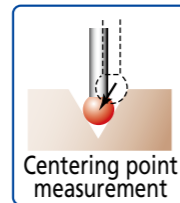

### Optional units

A wide variety of optional units, including rotary table MRT320 for synchronized scanning and the automatic stylus change system, is available.

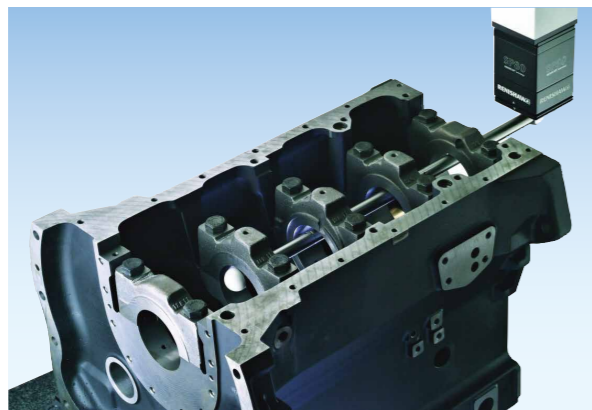

## SP80 Specifications

SP80	Measuring range	±2.5 mm
	Scanning error	MPE <sub>THP</sub> ≤ 2.0 μm (CRYSTA-Apex V700/900: when the ø4x50 mm stylus is used.)
	Spring rate	1.8 N/mm
	Max. stylus length	500 mm *1
	Max. stylus mass	500 g *1
	Stylus mount	M5 thread
	Max. scanning speed	120 mm/s [for known geometry scanning]
	Probe head	N/A
	Applicable models	CNC coordinate measuring machines *2

\*1 Increase in stylus length or stylus mass may reduce accuracy.

\*2 Note that some probes are subjected to the limitation of mounting or unable to mount.

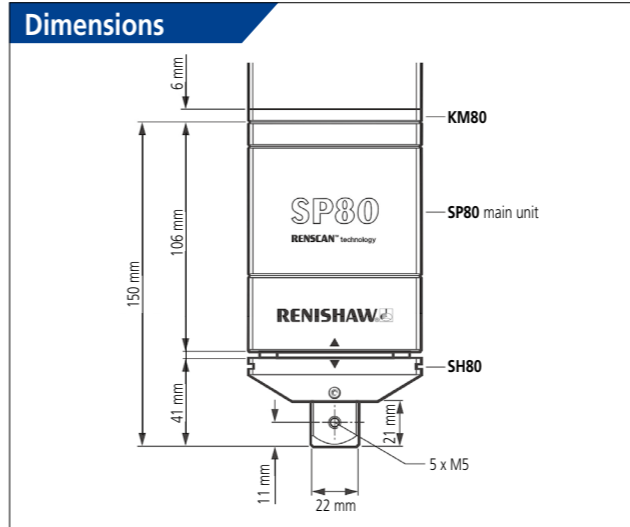

## Set configuration

### SP80 main unit

Description	Mass (kg)	Remarks
SP80 Probe kit #1	2.6	One SP80 main unit, SH80, KM80, and ø8X60 mm stylus

### Parts for SP80

Description	Qty
SP80 adapter	1
SP80 Probe cable	1
SP80 EXT cable	1
IU 80	1
SP80 Power Supply BOX	1
OPT200S-MPP2	1
OPT200 attachment	1
Control ROM (MAIN)	1
Control ROM (OPT)	1

Note: Some items cannot be ordered separately.

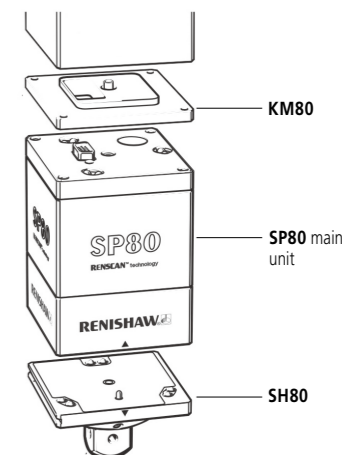

## Optional units Automatic Stylus Changer

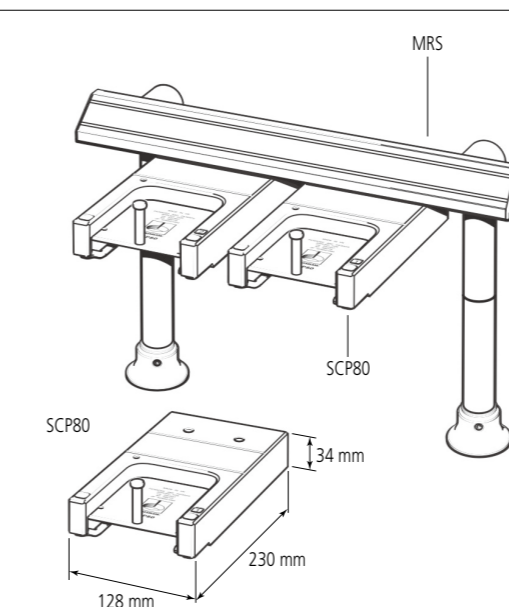

### SP80 stylus change set 1 (600 mm-rail specifications)

Description	Unit
MRS kit #2	1
SH80	1
SCP80	2
Rack plate (auxiliary plate)	1
ACR3 attachment screw	1

### SP80 stylus change set 2 (1000 mm-rail specifications)

Description	Unit
MRS kit #3	1
SH80	3
SCP80	4
Rack plate (auxiliary plate)	1
ACR3 attachment screw	1

# SP25M Compact High-accuracy Scanning Probe



### Compact high-accuracy scanning probes

The **SP25M** is a compact high-accuracy scanning probe with an outside diameter of  $\phi 25$  mm. This is a multi-functional probe designed for CNC coordinate measuring machines that can not only perform a continuous path contact-type scanning measurement [a measurement method that implements collection of a large amount of coordinate data while traveling along a continuous path in contact with the workpiece], but also high-accuracy point measurement and data collection from a centering point measurement.

### Fast scanning

For a scanning measurement either of the following scanning methods can be selected: one in which the scanning progresses while automatically following an unknown geometry (unknown geometry scanning), and one in which scanning progresses based on the locus of the probe tip given beforehand (known geometry scanning). With known geometry scanning it is possible to perform fast scanning at a maximum of 120 mm/s. Conventionally, it is normal to evaluate geometries such as a line or a circle through point measurement. However, for evaluating the flatness or roundness of an extra precision-machined workpiece, it is better to improve the reliability of a measurement result by evaluating the object at more measurement points. Naturally, it takes an extended amount of time for a touch-trigger probe to measure such an object point by point if very many points are involved. In contrast, the **SP25M** can, for example, complete a measurement in just a few seconds even if it is required to measure an inside diameter of 100 mm using 1000 measurement points. In addition, it can pursue any measurement effectively while changing the scanning speed, depending on the measurement accuracy required.

### Enhancing the setup and measurement efficiency through automatic change of probe orientations

Since the **SP25M** can be mounted on a probe head such as the **PH10M/PH10MQ** that automatically changes the probe orientation, it can greatly reduce the preparation time for measurement and for actual measurement in comparison to a conventional-type scanning probe whose position is fixed downward. In addition, the use of other probes, as advantaged by the probe change system, makes it possible to realize full automation in measuring various forms of machined parts.

### Optional units

An automatic stylus change system is available.

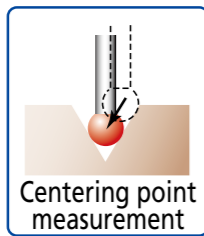

Centering point measurement

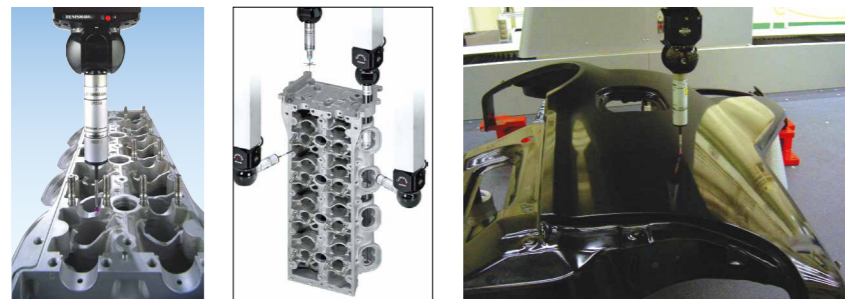

### SP25M Specifications

SP25M	Measuring range	$\pm 0.5$ mm
	Scanning error	$MPE_{TP} \leq 2.3 \mu\text{m}$ (CRYSTA-Apex V700/900: when the $\phi 4 \times 50$ mm stylus is used.)
	Spring rate	0.2~0.6 N/mm
	Amount of over travel	XY: $\pm 2$ mm Z: +1.7 mm/-1.2 mm
	Max. stylus length	200 mm (When SM25-3 or SH25-3 is used.)*
	Stylus mount	M3 threaded
	Max. scanning speed	120 mm/s [for known geometry scanning]
	Probe head	Essential: <b>PH10M/PH10MQ</b>
	Applicable models	CNC coordinate measuring machines

\* Increase in stylus length or stylus mass may deteriorate the accuracy.

### Dimensions

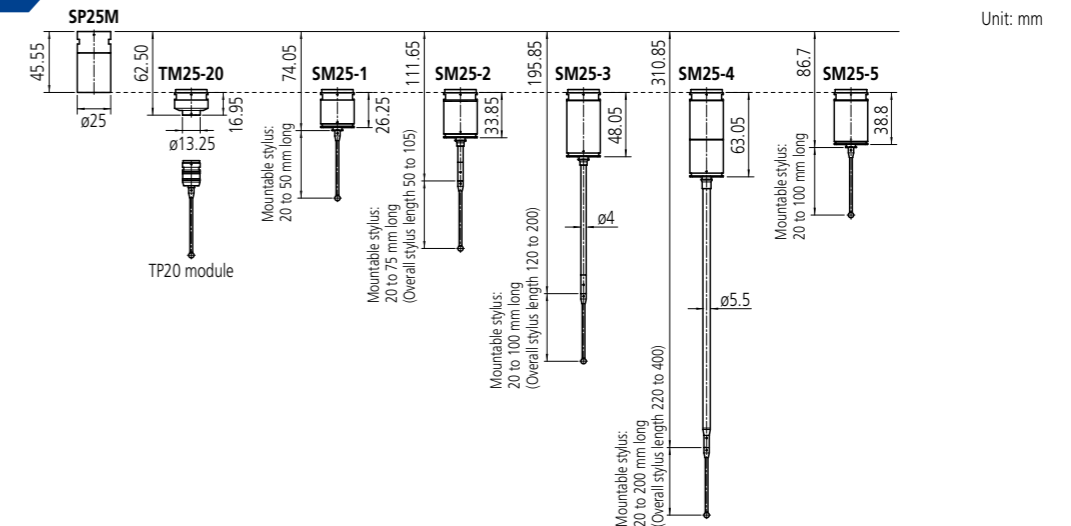

Unit: mm

### Configuration



Description	Remarks
<b>SP25M</b> full combination kit	A complete set of SP25M, SM25-1/2/3, SH25-1/2/3, and TM25-20
<b>SP25M</b> probe kit #1	A complete set of SP25M, SM25-1, and SH25-1
<b>SP25M</b> probe kit #2	A complete set of SP25M, SM25-2, and SH25-2
<b>SP25M</b> probe kit #3	A complete set of SP25M, SM25-3, and SH25-3
<b>SP25M</b> probe kit #4	A complete set of SP25M, SM25-4, and SH25-4
<b>SP25M</b> probe kit #5	A complete set of SP25M, SM25-5, and SH25-5
<b>SM25M</b> scanning module kit #1	A complete set of SM25-1 and SH25-1
<b>SM25M</b> scanning module kit #2	A complete set of SM25-2 and SH25-2
<b>SM25M</b> scanning module kit #3	A complete set of SM25-3 and SH25-3
<b>SM25M</b> scanning module kit #4	A complete set of SM25-4 and SH25-4
<b>SM25M</b> scanning module kit #5	A complete set of SM25-5 and SH25-5
Stylus holder SH25-1	
Stylus holder SH25-2	
Stylus holder SH25-3	
Stylus holder SH25-4	
Stylus holder SH25-5	
TM25-20 TP20 adapter kit	A set of TP20 standard force module and TM25-20
TM25-20 TP20 adapter	

Note: TTP module (TP20module) will be supported for MCOSMOS V2.4 or later releases.

### Optional units Auto module changer/Automatic Stylus Changer

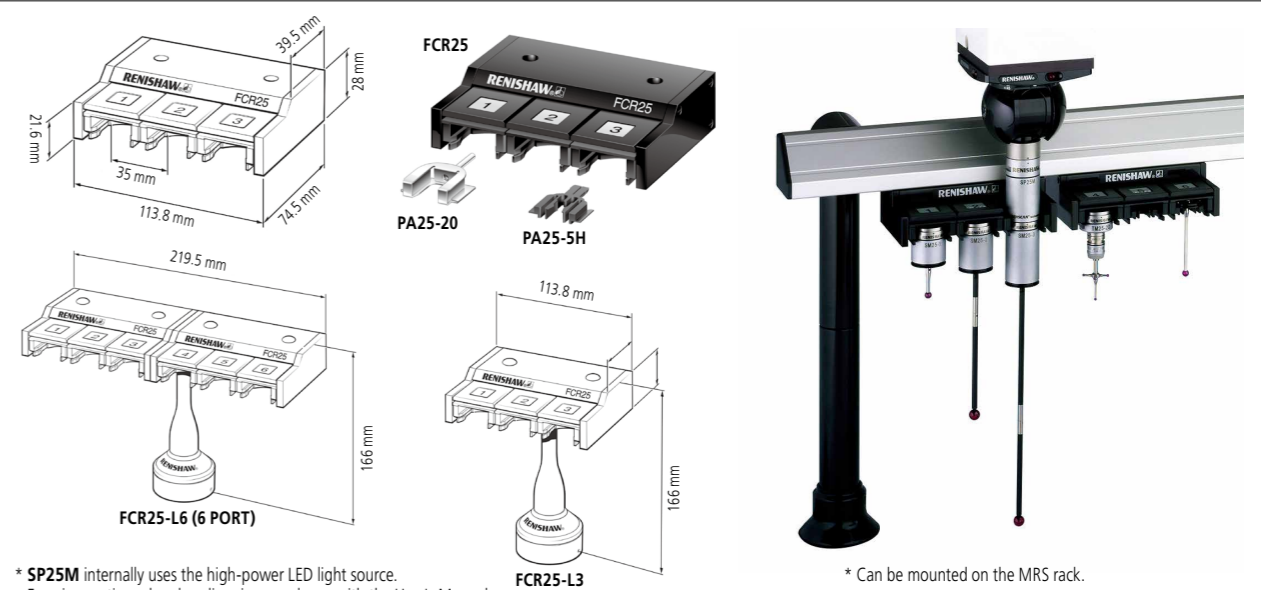

\* **SP25M** internally uses the high-power LED light source. Exercise caution when handling, in accordance with the User's Manual.

\* Can be mounted on the MRS rack.

# SP600Q High-accuracy Scanning Probe

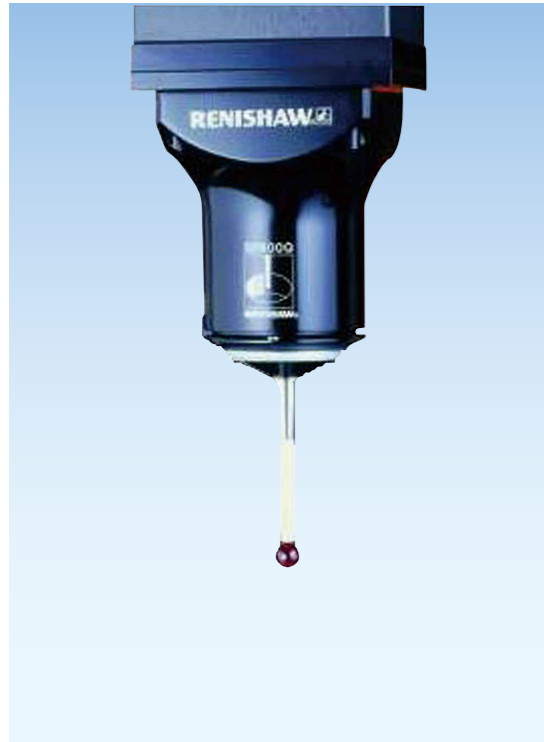

### Compact high-accuracy scanning probes

**SP600Q** is a high-accuracy scanning probe which can be mounted on the CRSTA-Apex V500 series. It performs not only scanning measurement (measurement method that collects a large amount of coordinate data while traveling along a path in contact with the workpiece), but also high-accuracy point measurement. Direct-mount of this probe on the Z spindle of CRYSTA-Apex V500 allows more effective usage of measurement space.

### Fast scanning

For a scanning measurement either of the following scanning methods can be selected: one in which the scanning progresses while automatically following an unknown geometry (unknown geometry scanning), and one in which scanning progresses based on the locus of the probe tip given beforehand (known geometry scanning). With known geometry scanning it is possible to perform fast scanning at a maximum of 120 mm/s. Conventionally, it is normal to evaluate geometries such as a line or a circle through point measurement. However, for evaluating the flatness or roundness of an extra precision-machined workpiece, it is better to improve the reliability of a measurement result by evaluating the object at more measurement points. Naturally, it takes an extended amount of time for a touch-trigger probe to measure such an object point by point if very many points are involved. In contrast, the **SP600Q** can, for example, complete a measurement in just a few seconds even if it is required to measure an inside diameter of 100 mm using 1000 measurement points. In addition, it can pursue any measurement effectively while changing the scanning speed, depending on the measurement accuracy required.

### Optional units

An automatic stylus change system is available.

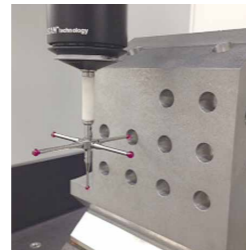

### Dimensions

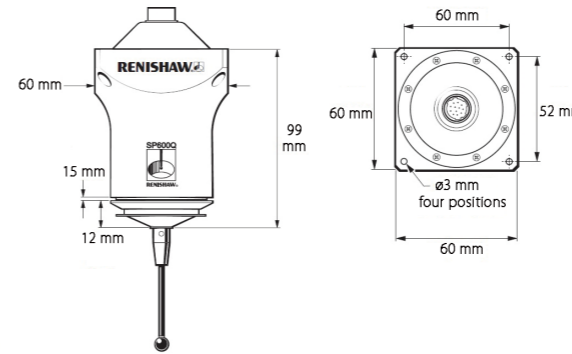

### Set (No. 06ADV933) configuration

Description	Part No.	Qty
<b>SP600Q</b> Probe kit	<b>06ADV597</b>	1
Spacer A for <b>SP600Q</b>	<b>06ADU577</b>	1
Spacer B for <b>SP600Q</b>	<b>06ADU578</b>	1
<b>SP600Q</b> Head cable	<b>06ADU687</b>	1
SP600 IF cable	<b>06AAS624A</b>	1
ø4L50 stylus (MS4-4R33C)	<b>06ABQ149</b>	1
L50 Extension (MS4-EXT50C)	<b>06ABN849</b>	1
Stylus center (MS4-stylus center)	<b>06ABN857</b>	1
Knuckle joint (MS4-stylus knuckle)	<b>06AAD460</b>	1
<b>SP600Q</b> User's Manual	<b>99MCA562A</b>	1

### SP600Q Specifications

<b>SP600Q</b>	Measuring range	±1 mm (X, Y, Z)
	Min. reference displacement	0.15 mm
	Spring rate	1.2 N/mm
	Measuring force	0.17~1.18 N (18~120 gf) Varies depending on the probe displacement.
	Max. stylus mass	Max. 20 g *1
	Max. stylus length	Max. 200 mm *1
	Stylus mount	M4 thread
	Probe head	Unnecessary
	Applicable models	CNC coordinate measuring machine *2

\*1 Increase in stylus length or stylus mass may reduce the accuracy.

\*2 Note that some probes are subjected to the limitation of mounting or unable to mount.

### Optional units Stylus Changer SCR600

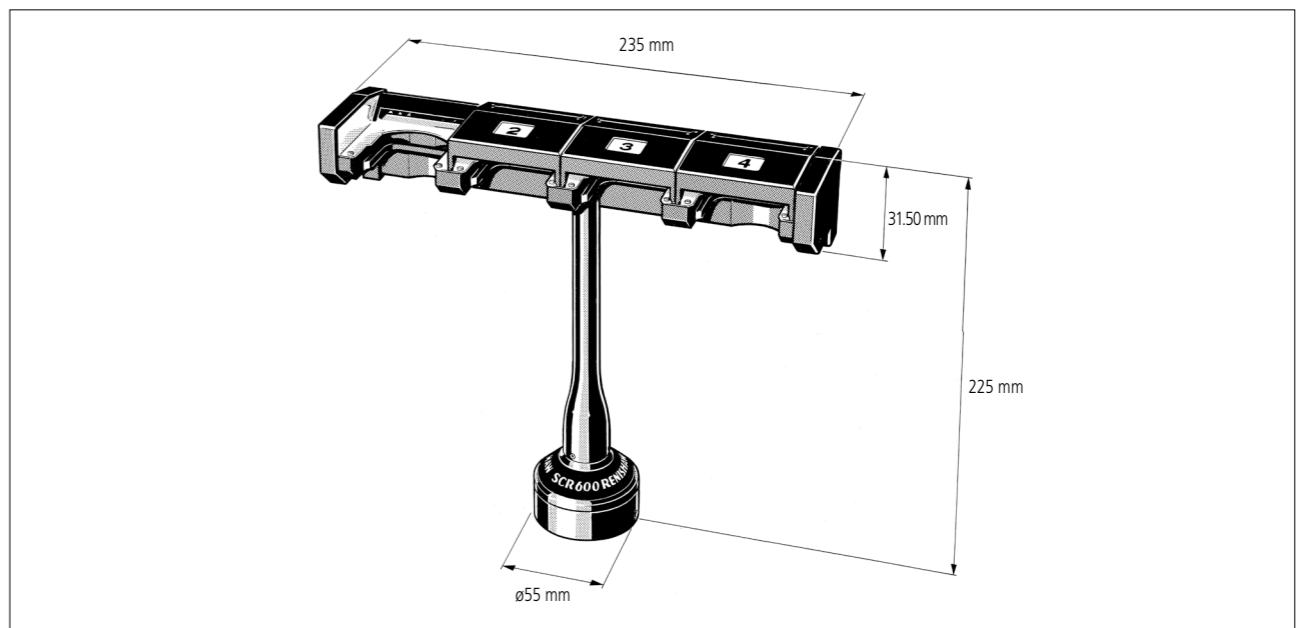

# SurfaceMeasure Non-contact Laser Probe



### High-speed scanning

SurfaceMeasure is a probe that captures coordinates data from a workpiece by shining a laser on the surface. This method allows ultra-fast data acquisition of 300,000 points/sec\*.  
\* When SurfaceMeasure 1110 is used

### Advantage of non-contact measurement

Non-contact measurement makes it possible to measure elastic bodies such as resin and thin-walled parts which are not suitable for contact measurement.

### Powder-sprayless measurement

By automatically adjusting the laser intensity and camera sensitivity according to the environment and the workpiece material, the SurfaceMeasure has achieved powder-sprayless measurement, providing a simpler and more comfortable laser-scanning environment.

### Application examples

Obtained point-cloud data can be used for various purposes with optional software, such as editing, surface generation, comparing with CAD data, creating CAD data, etc.

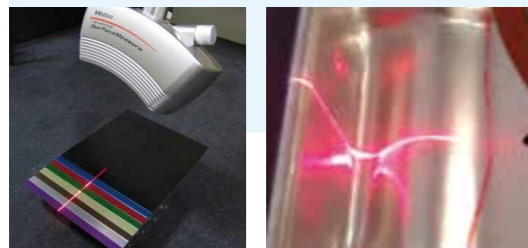

Measurement of color sample plate

Measurement of shiny workpiece



403

1110

201FS

## SurfaceMeasure

Item/Model	SurfaceMeasure 403	SurfaceMeasure 1110	SurfaceMeasure 201FS
Laser irradiation method	Beam expansion		Flying spot
Max. scan width	40 mm	110 mm	23 mm
Max. scan depth	30 mm	100 mm	15 mm
Working distance	66 mm	156.5 mm	57.5 mm
Scanning error *1	8 μm	9 μm	-
Probing dispersion value*2 (95%) P form.Sph.D95% Tr.OOS	- *3	36 μm	8.0 μm
Max. Acquisition rate	60,000 points/sec	300,000 points/sec	25,000 points/sec.
Mass	430 g	440 g	500 g
Laser Class	ENIEC	Class2 [ IEC 60825-1: 2014/ EN 60825-1: 2014+A11:2021 ]	
	JIS	Class2 [ JIS C 6802: 2014 ]	
	Laser Type	Semiconductor	
Line Laser	Wave length	660 nm	
	Output	4 mW	2.5 mW

\*1 According to Mitutoyo's test procedure. (1 σ /sphere measurement, probe alone)

\*2 According to ISO10360-8:2013 test procedure. (probe alone)

\*3 Please contact your local Mitutoyo office.

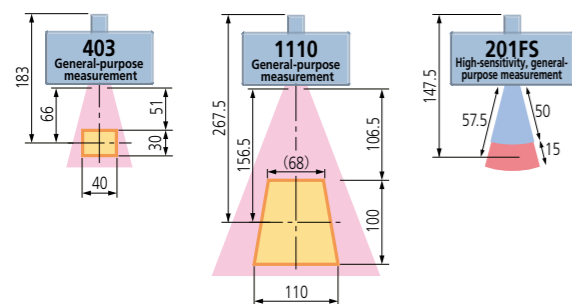

## MSURF-S/MSURF-I

### Scanning (MSURF-S)

Scanning paths can be created by simply defining three items: the scanning starting point, the scanning length, and the scanning width. These three items can be easily defined by using the joystick while checking the camera preview.

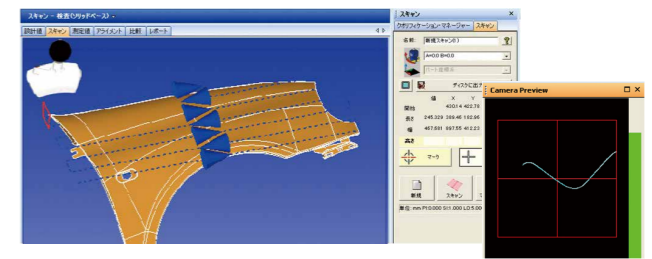

### • MSURF PLANNER (optional)

MSURF PLANNER software automatically generates measurement macros (surface shape, element shape) for line laser probes from 3D CAD data. The optimized measurement path (movement path, number of probe head rotations, etc.) helps increase productivity.

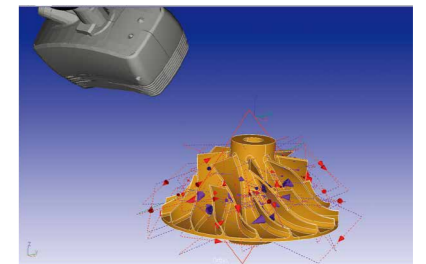

Automatic generation of measurement macros by MSURF PLANNER

Since MSURF-S can be started from MCOSMOS, automatic measurements that merge "contact" and "non-contact" measurements can be executed.

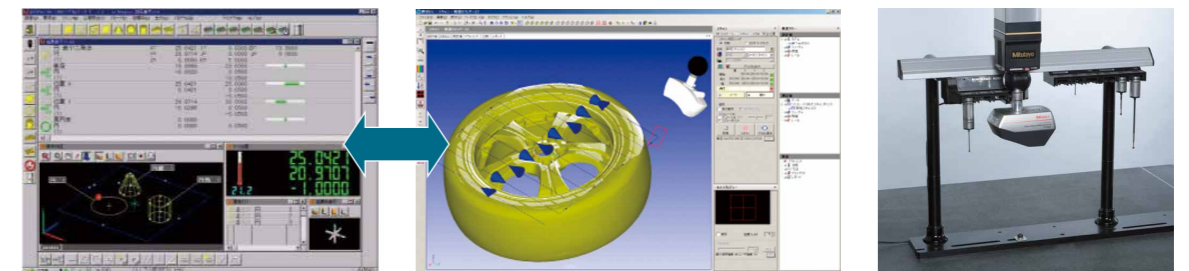

\* If the work coordinate system created in MCOSMOS is used, positioning by the software programs designed for processing point-cloud data is not required.

\* Note: If ACR3 is not used, the probe must be manually changed.

### Inspection (MSURF-I)

#### • Planar shape comparison

Point-cloud data or mesh data can be compared with CAD data, and the planar shape errors displayed on a color map.

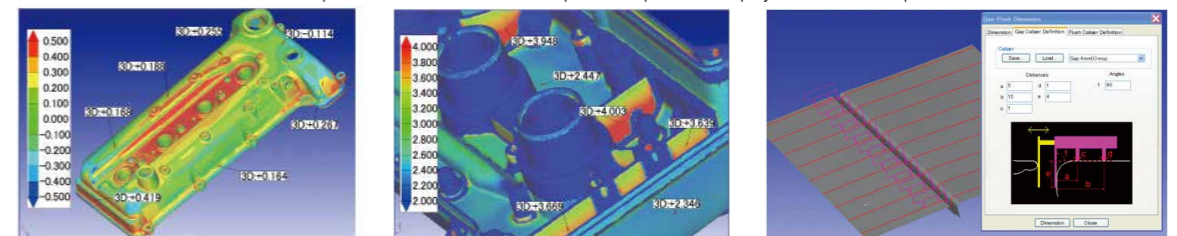

Color map of errors

Color map of wall thickness

Evaluation of steps and gaps

#### • Comparison of cross-sectional shapes

Point-cloud data / mesh data and CAD data can be cut at the specified position to compare cross-sectional shapes or compute angles, distances, radii, etc.

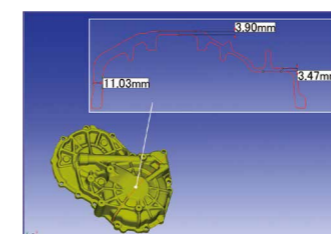

Cross-sectional evaluation (dimension computation)

#### • Feature-by-feature comparison

Various features can be detected from point-cloud data or mesh data and compare them to the design data.

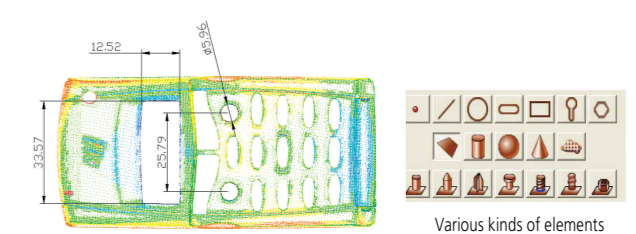

Various kinds of elements computation

# QVP Quick Vision Probe



### Provides image measuring capability for coordinate measuring machines

The **QVP** probe performs form measurement by image processing micro geometry that cannot be measured by a contact type probe, or elastic bodies that are easily deformed by slight measuring forces. Although the method of microscopic measurement with a centering microscope mounted on the coordinate measuring machine has been used since coordinate measuring machines came into use in the industry, they have an inherent disadvantage in that the operation of identifying positions is dependent on the operator's eye, resulting in possible measurement errors. Even with a CNC coordinate measuring machine manual measurement must be performed sometimes, such as with an installed centering microscope. The **QVP** probe is a vision probe dedicated for coordinate measuring machines and was developed based on Mitutoyo's state-of-the-art technology, in order to enable full automation of image measurement with a CNC coordinate measuring machine.

### Automatic detection of workpiece edge

The **QVP**-captured image will have various automatic edge detections performed by the dedicated software, VISIONPAK, and then various calculation processes (calculation of dimensions and geometrical deviations) will be performed by the general-purpose measurement program, Geopak.

### Standard provision of white LED illumination

Since the **QVP** is equipped with the standard co-axial light running through the lens system as well as white-light LED ring illumination, which is bright and has a long service life, no auxiliary illumination is required. The light volume can be set to between 0 and 100% in 1% increments.

### Use with an Automatic Probe Changer

The **QVP** can also be mounted on an automatic probe changer, allowing full-automatic measurement with both contact and non-contact probes.



## QVP Specifications

<b>QVP main unit</b>	CCD size	1/3 inch (BAW)			
	Optical tube magnification	0.375x			
	Illuminating function	Co-axial	White light LED source (built-in): Power dissipation 5 W or less		
		Ring	White light LED source: Power dissipation 10 W or less		
	Mass	Automatic-joint type: 315 g, shank type: 390 g			
<b>Objective</b>	Optical magnification	0.375x	1.125x	1.875x	3.75x
	Observation range (mm)	9.6x12.8	3.2x4.3	1.9x2.6	1x1.3
	Working distance (mm)	61	72.3	61	51
	Magnification	ML1x	ML3x	ML5x	ML10x
		Optional	Standard	Optional	Optional
Numerical Aperture (N.A.)	0.03	0.09	0.13	0.21	
Depth of focus (μm)	306	34	16.3	6.2	
<b>QVP I/F BOX</b>	Mass	80 g	55 g	60 g	95 g
	Supply voltage	AC100 to 240 V			
	Frequency	50/60 Hz			
	Power capacity	30 W			
	Mass	3800 g			

## Dimensions

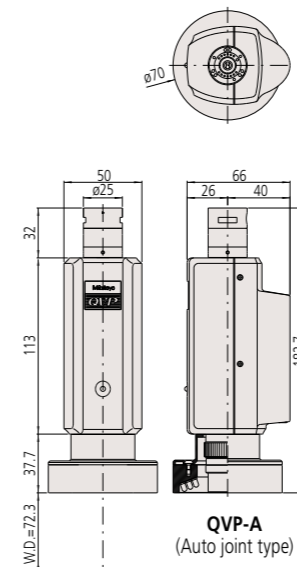

Unit: mm

## Optional accessories



- Objective ML1X (375-036-2)
- Objective ML5X (375-034-1)
- Objective ML10X (375-039)



- Calibration gage (02AQC310)
  - Gage for sharing the coordinates between the QVP and contact-type probe

- Calibration chart (02AKN020)
  - Gage for calibrating a single QVP unit



## Data processing unit

### Dedicated data processing software VISIONPAK

VISIONPAK operates under the Microsoft Windows operating system and is a general-purpose measurement program for coordinate measuring machines. It displays the image window when it detects a workpiece edge. After detecting an edge, it undertakes various calculations with the regular general-purpose measurement programs.

### Wide variety of image processing functions

With its powerful image processing functions (tools), it can detect various forms of edges at high speed. It can measure in the height direction by means of its auto-focus function, and save the captured image as the image data (bitmap format).

### Outlier removal function

In ordinary micro-form measurement it is often difficult to remove burrs and dusts from the objective workpiece, resulting in an inevitable measurement error. In contrast, VISIONPAK can recognize, for example, the obstruction as an "outlier" and bypass it during measurement.

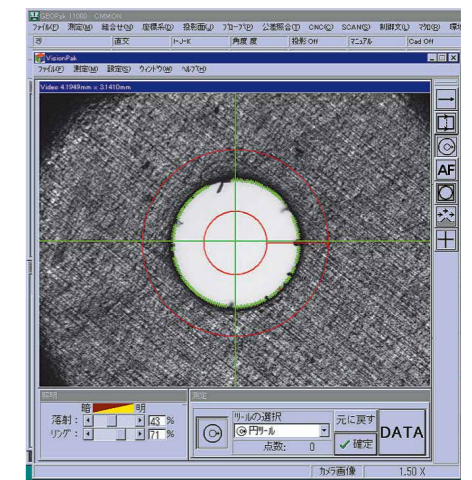

## VISIONPAK Image Processing Tool



### Simple tool

Used for detecting a single point on the edge pointed to by the arrow.

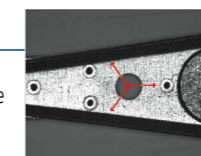

### Manual tool

Used for detecting an optional position pointed to (clicked on) by the mouse.

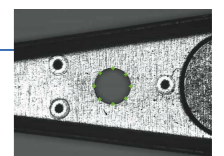

### Box tool

Used for multiple-point line measurement of an edge caught in the box

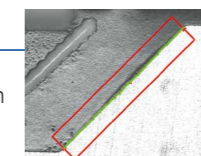

### Centroid tool

Used for detecting the center of gravity of an optional form.



### Circle tool

Used for multiple-point measurement of a circle for the objective circular edge. As with the box tool, it can collect data that is free from the effect of burrs and dust.

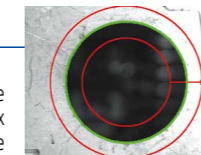

### Edge self-tracing tool

By simply specifying the start point and measurement interval, the objective edge can be detected while automatically tracing an unknown geometry.

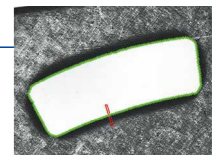



# CF20 Centering Microscope for Coordinate Measuring Machines



### Use the coordinate measuring machine as a large microscope

The **CF20** is a centering microscope that enables measurement of small holes and elastic bodies which are difficult for a touch-trigger probe to measure. With the CF20 the coordinate measuring machine can be used as a large microscope.

### Optional accessories to implement various evaluations

To cope with the size and form of a workpiece to be observed and measured, lenses of various magnifications and reticles for form comparison are provided.

### CCTV Monitor System for CMM with CF20 (optional)

CCD camera (optional) to be installed on model **CF20**. The image can be viewed on the monitor of the PC on which the dedicated software is installed. This is a great aid in relieving eye stress, especially if several hours of work must be done.

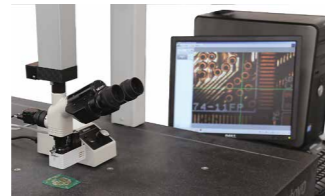

CCTV Monitor System for CMM with CF20 (optional)

### Objectives (optional)

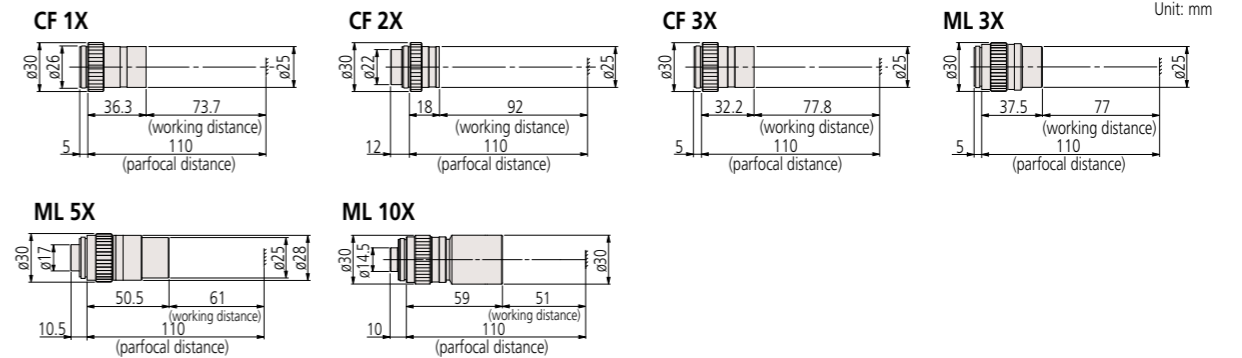

Code No.	Description	Numerical Aperture (N.A.)	Working distance W.D. (mm)	Resolution R (μm)	Depth of focus of single objective lens ±D.F. (μm)	Mass (g)
375-031	CF 1X	0.03	73.7	9.2	306	45
375-032	CF 2X	0.06	92	4.6	76	35
375-033	CF 3X	0.07	77.8	3.9	56	35
375-037-1	ML 3X	0.09	77	3.06	34	55
375-034-1	ML 5X	0.13	61	2.12	16.3	60
375-039	ML 10X	0.21	51	1.31	6.2	95

\* Values for resolution and depth of focus of a single objective lens are calculated based on the reference wavelength ( $\lambda = 0.55 \mu\text{m}$ ).  
\* The real field of view (mm) can be obtained from Field number/Objective magnification.

### CF20 monocular set dimensions

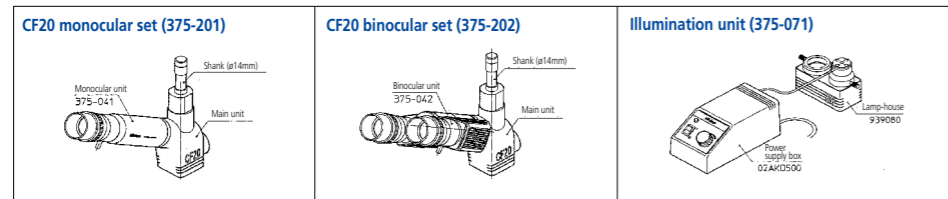
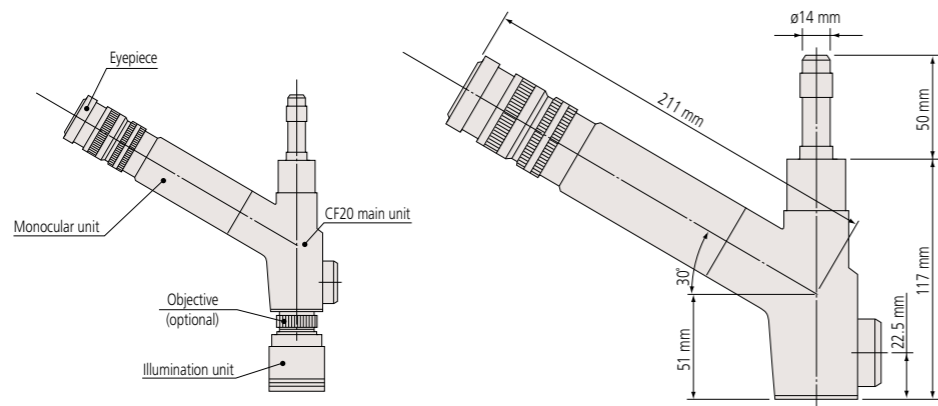

### CF20 main unit

Description	Specification	Objective	Accessory
<b>CF20 monocular set (375-201)</b>	CF10X eyepiece, field number 22 Cross hair and concentric circle reticle	-	1. Illumination unit (375-071) 2. Spare lamp (162151) 3. Lens cap 4. Tools
<b>CF20 binocular set (375-202)</b>	CF10X eyepiece, field number 22 / Cross hair and concentric circle reticle (right) Pupil distance adjustment: 51 - 76 mm	-	5. Power cable 6. User's Manual 7. Storage box

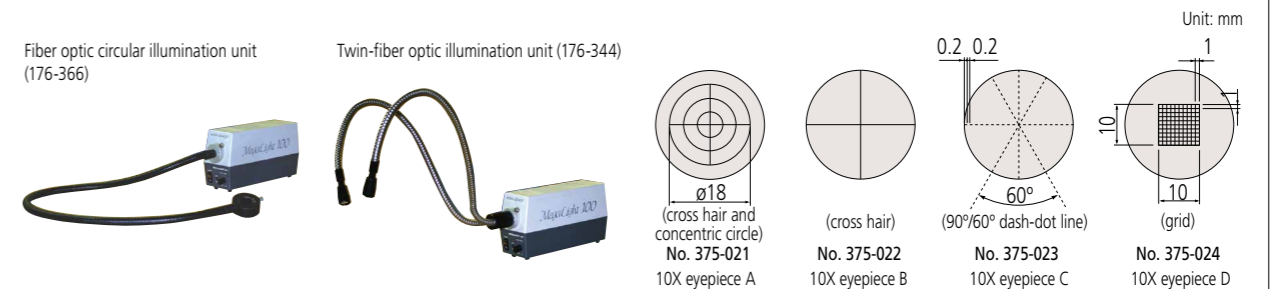

### CCTV Monitor System for CMM with CF20 [Code No. 320-055]

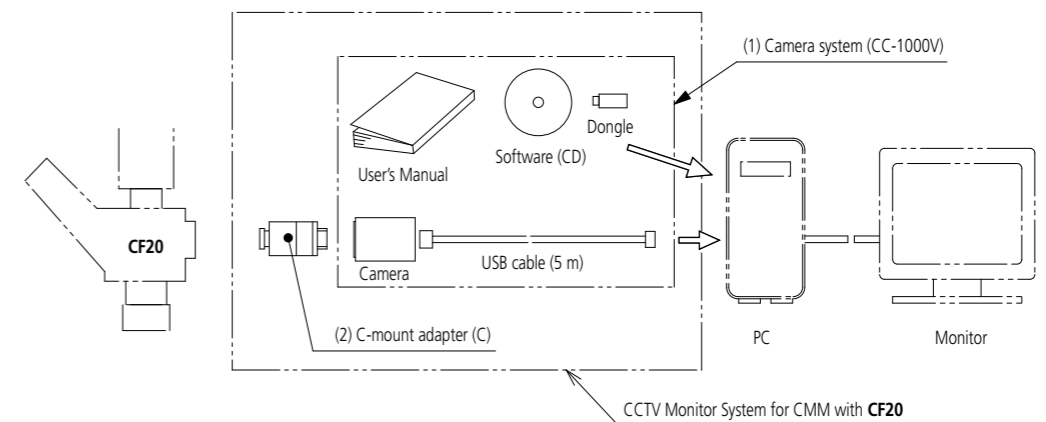

Ref. No.	Description	Qty
1	Camera system	1
2	C-mount adapter (C)	1

# SURFTTEST PROBE Surface Roughness Probe



### Roughness measurement function added to CNC CMM

The **SURFTTEST PROBE** is a probe that can measure surface roughness while mounted on a CNC coordinate measuring machine.

This probe uses a skid-type roughness detector that allows roughness measurement using a linear drive inside the probe. Dedicated software SURFPAK-SP is used for roughness measurement and analysis.

### Batch processing from dimensional measurement to roughness measurement

This probe allows contact roughness measurement without changing a workpiece setup on a CMM. If a SURFTTEST probe is mounted on the PH10M/PH10MQ, roughness measurement of tilted surfaces is enabled by changing the probe orientation. The CMM can also use other CMM probes along with a SURFTTEST probe, thus allowing fully automatic measurement from dimensions to surface roughness using the Auto Probe Changer ACR3, etc.

### Options

Thanks to the knowhow accumulated in the portable surface roughness tester SJ series, several types of surface roughness detectors are available to suit various types of workpiece. A cleaning unit (option) is also available to clean the roughness detector should it become contaminated with coolant, etc. This allows improvement in reliability of roughness measurement.

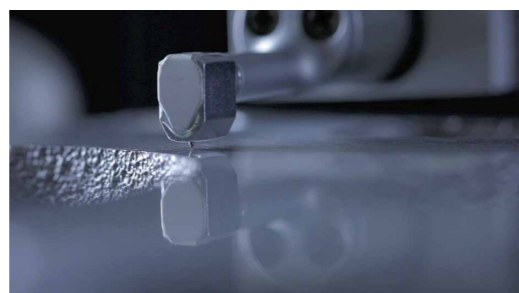
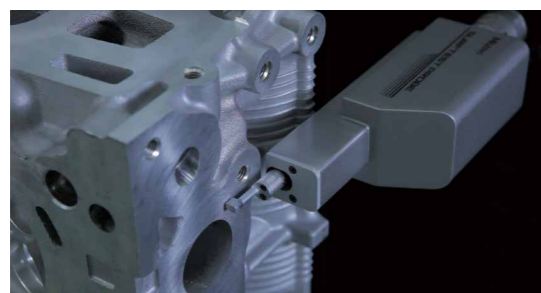

### SURFPAK-SP

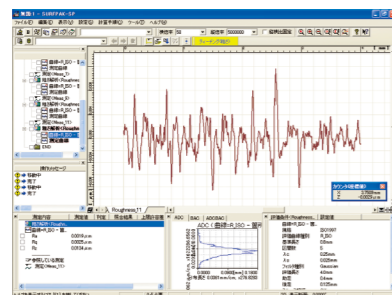

SURFPAK-SP is a software program specific to the **SURFTTEST** surface roughness probe for a CMM, and allows surface roughness analysis conforming to standards such as ISO, JIS, ANSI and VDA. Working with MCOSMOS, fully automatic dimensional measurement and surface roughness measurement are enabled.

### SURFTTEST PROBE Specifications

SURFTTEST PROBE	Measuring range	AUTO, 25, 100, 360 μm
	Drive range	17.5 mm
	Measuring speed	0.25, 0.5, 0.75 mm/s
	Stylus tip radius	2 μm
	Measuring force	0.75 mN

### Dimensions

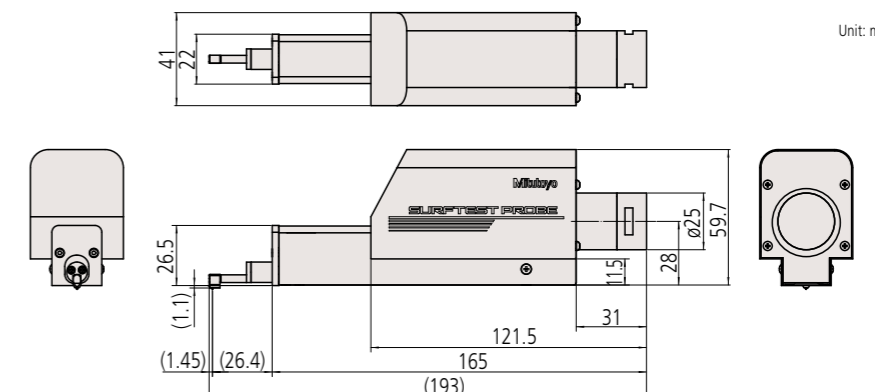

### Configuration

Description	Qty
<b>SURFTTEST PROBE Set</b>	
SURFTTEST PROBE main unit	1
Storage box	
SURFTTEST PROBE Interface unit	1
USB CBL	1
Hardware guide	1

### Optional units

#### Essential options

① Roughness detector	<b>178-270</b> (0.75 mN, 60° R2 μm)
	<b>178-280</b> (4 mN, 90° R5 μm)
② Roughness specimen	<b>178-601</b> (mm)
	<b>178-602</b> (inch/mm)

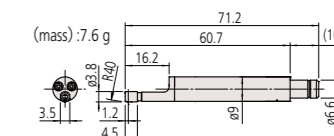
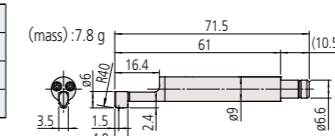

#### Option

Part No.	Name
<b>178-270</b>	Roughness detector (0.75 mN, 60° R2 μm)
<b>178-280</b>	Roughness detector (4 mN, 90° R5 μm)
<b>178-281</b>	Roughness detector (4 mN, 90° R10 μm)
<b>178-272</b>	Small hole detector (0.75 mN, 60° R2 μm)
<b>178-282</b>	Small hole detector (4 mN, 90° R5 μm)
<b>178-273</b>	Extra small hole detector (0.75 mN, 60° R2 μm)
<b>178-283</b>	Extra small hole detector (4 mN, 90° R5 μm)
<b>178-274</b>	Deep groove detector (0.75 mN, 60° R2 μm)
<b>178-284</b>	Deep groove detector (4 mN, 90° R5 μm)
<b>178-275</b>	Gear-tooth surface detector (0.75 mN, 60° R2 μm)
<b>178-285</b>	Gear-tooth surface detector (4 mN, 90° R5 μm)

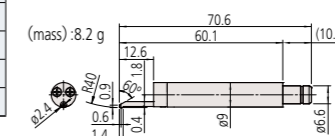
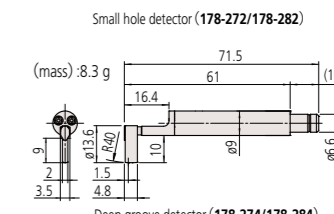
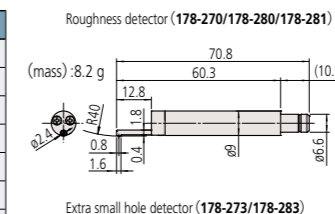

#### Optional parts

Part No.	Name
<b>02AQJ101</b>	Cleaning unit
<b>02AQJ207</b>	Calibration stage
<b>02AQJ210</b>	Support magnet (ACR3)

# TP7M High-Accuracy Touch-trigger Probe



### High-accuracy touch-trigger probes

This is a high-accuracy touch-trigger probe with a maximum repeatability of  $2\sigma \leq 0.25 \mu\text{m}$ .

### Enhancing the setup and measurement efficiency through automatic change of probe orientations

Since the **TP7M** can be mounted on a probe head, such as the **PH10M/PH10MQ** that automatically changes the probe orientation, it can greatly reduce the preparation time for measurement and for actual measurement in comparison to a conventional-type scanning probe with a position that is fixed downward. In addition, the use of other probes, as advantaged by the probe change system, makes it possible to realize full automation in measuring various forms of machined parts.

### Suitable for use with long styli

The **TP7M** can mount a stylus up to 150 mm long\*. In combination with the longest extension of 200 mm equipped for the **PH10M/PH10MQ**, it can reach a position at a maximum distance of 350 mm.

\* This maximum length may vary with the coordinate measuring machine main unit being used and/or the material/diameter of the stylus itself.



## TP7M Specifications

<b>TP7M</b>	Measuring direction	$\pm X, \pm Y, \pm Z$	
	Standard stylus	$\varnothing 4 \times 18 \text{ mm}$	
	Repeatability ( $\sigma$ )	0.125 $\mu\text{m}$ or less (When the standard stylus is used.)	
	Directionality (XY: 2D)	$\pm 0.25 \mu\text{m}$ or less	
	Required force to generate trigger signal	XY	0.02 N (When the 50 mm stylus is used.)
		Z	0.15 N (When the 50 mm stylus is used.)
	Amount of over-travel	XY	$\pm 16^\circ$
		Z	$\pm 5 \text{ mm}$
	Required force to achieve over-travel	XY	0.49 N (When the 50 mm stylus is used.)
		Z	2.94 N (When the 50 mm stylus is used.)
	Maximum stylus length	150 mm*	
	Stylus mounting method	M4 thread	
Mass of a single unit	85 g		
Durability	10,000,000 times		
Probe head	Essential: PH10M/PH10MQ		
Applicable models	CNC coordinate measuring machines		

\* Increase in stylus length or stylus mass may deteriorate the accuracy.

## Dimensions

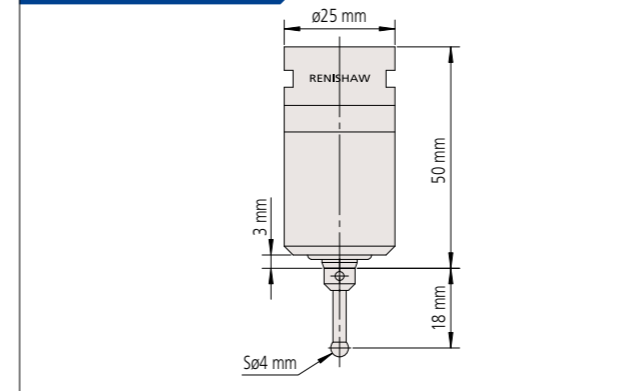

## TP7M Set

Ref. No.	Description	Qty
1	TP7M main unit	1
2	Joint key S10	1
3	M4 Stylus tool	2

# TP200 Compact High-Accuracy Touch-trigger Probe

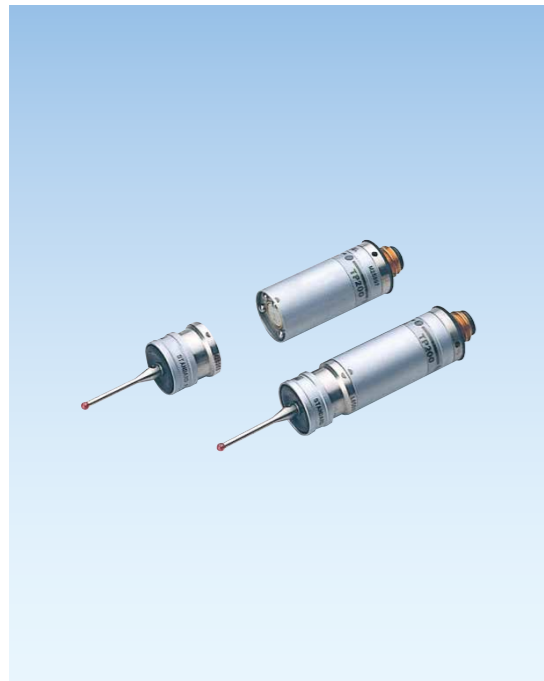

### Compact high-accuracy touch-trigger probes

This touch-trigger probe has an outside diameter as small as  $\phi 13.5$  mm, which greatly contributes to probing complex portions of a workpiece. With the combined use of an appropriate probe extension it can probe even deeper locations.

### Enhancing the setup and measurement efficiency through the automatic change of probe orientations

Since the TP200 can be mounted on a probe head, such as the PH10M/PH10MQ that automatically changes the probe orientation, it can drastically reduce the time required to prepare for measurement and for actual measurement in comparison to a conventional-type scanning probe with a position that is fixed downward.

### Automatic stylus change

If the measurement cannot be performed by merely changing the probe orientation (such as when it is impossible to measure without replacing the normal stylus with one that has a different diameter or unique form), this automatic stylus change via the stylus change system allows fully automatic measurement to be completed without being interrupted mid-course. In addition, working with other probes, as advantaged by the probe change system, makes it possible to realize full automation in measuring various forms of machined parts.

### Dimensions

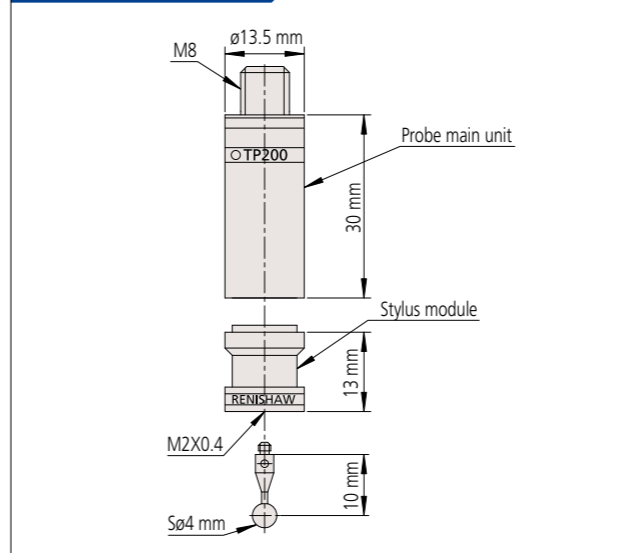

### Set configuration

Unit	Ref. No.	Description	Qty	Remarks	
Touch-trigger probe TP200 set 06AAL268	A complete set of TP200 probe	1	TP200 probe	1	
		2	Stylus module (standard)	1	Standard measuring force (at over-travel)
		3	Cleaning tool	1	For cleaning the stylus module
		4	Twin-ended wrench	1	For attaching/detaching the probe (S1)
		5	Double-ended wrench	1	For attaching/detaching the probe (S9)
	Stylus set for TP200 06AAL252	6	Stylus tool	1	For attaching/detaching the stylus (S7)
		7	MS2-4R10	1	Standard stylus $\phi 4 \times 10$ (M2)
		8	MS2-6R10	1	$\phi 6 \times 10$ (M2)
		9	MS2-4R20	1	$\phi 4 \times 20$ (M2)
		10	MS2-EXT40G	1	Extension 40 mm Carbon fiber
		11	MS2-EXT50G	1	Extension 50 mm Carbon fiber
		12	Carbon extension attachment tool	1	
		13	Wooden box	1	Stylus storage box
		14	User's Manual	1	

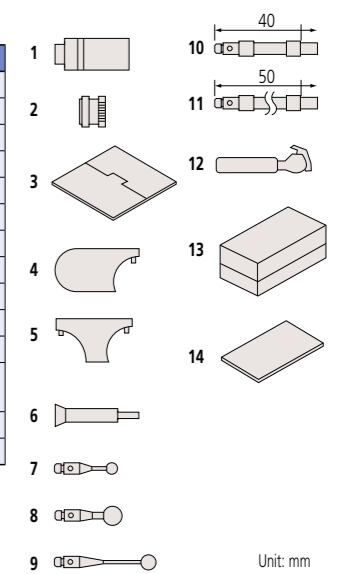

Note: Some items cannot be ordered separately.

### TP200 Specifications

TP200	Measuring direction	$\pm X, \pm Y, \pm Z$
	Repeatability ( $2\sigma$ )	0.3 $\mu\text{m}$ or less (with 10 mm stylus), 0.4 $\mu\text{m}$ or less (with the 50 mm stylus)
	Directionality (XY: 2D)	$\pm 0.4$ $\mu\text{m}$ or less (with 10 mm stylus), $\pm 0.8$ $\mu\text{m}$ or less (with the 50 mm stylus)
	Directionality (XYZ: 3D)	$\pm 0.65$ $\mu\text{m}$ or less (with 10 mm stylus), $\pm 1$ $\mu\text{m}$ or less (with the 50 mm stylus)
	Required force to generate trigger signal	XY 0.02 N (STANDARD/LOW FORCE), where a 50 mm stylus is used.
		Z 0.07 N (STANDARD/LOW FORCE), where a 50 mm stylus is used.
	Amount of over-travel	XY $XY \pm 14^\circ$
		Z +4.5 mm (with 0.07 N), +3 mm (with 0.15 N)
	Required force to achieve over-travel	XY 0.35 N (STANDARD FORCE) 0.1 N (LOW FORCE)
		Z 1.5 N (STANDARD FORCE) 1 N (LOW FORCE)
		Maximum stylus length
	Maximum stylus mass	STANDARD FORCE : 4.5 g, LOW FORCE : 1.5 g
	Stylus mounting method	M2 thread
	Mass of a single unit	22 g
	Durability	10,000,000 times
	Probe head	Essential: PH10M/PH10MQ/MIH/PH1
	Applicable models	CNC coordinate measuring machines
	Note:	Any stylus less than $\phi 1$ mm should be used with the LOW FORCE module. Not suitable for use in strong magnetic fields.
SCR200 (optional)	Stylus module replacement accuracy	Repeated positioning accuracy: 1.0 mm or less (through automatic change), when a 50 mm stylus is used. *2.0 mm or less at a manual replacement: when a 50 mm stylus is used.
	Number of stylus modules that can be mounted	Maximum 6 units

\*  $\phi 1$  mm stylus should be used with the LOW FORCE module as well.

### Optional accessories Stylus module automatic changer SCR200

#### Automatic stylus change system kit (Code No. 06AAL540)

No.	Description	Qty	Specification (use)	Mass (kg)
1	Stylus module (low measuring force)	1	For ball stylus less than $\phi 1$	0.01
2	Stylus module (standard)	3	Standard measuring force (at over-travel)	0.04
3	SCR200 kit	1	With a rack mount kit	0.93
4	PL63	1	PI200-SCR200 connection cable	0.15

\* Depending on the stylus to be equipped, the stylus and SCR200 may interfere.



# TP20 Compact Touch-trigger Probe



### Compact touch-trigger probes

This touch-trigger probe has an outside diameter as small as  $\phi 13.2$  mm, which greatly contributes to probing complex portions of a workpiece. With the combined use of an appropriate probe extension it can probe even deeper locations.

### Enhancing the setup and measurement efficiency through the automatic change of probe orientations

Since the TP20 can be mounted on a probe head such as the PH10M/PH10MQ that automatically changes the probe orientation, it can drastically reduce the time required to prepare for measurement and for actual measurement in comparison to a conventional-type scanning probe that has a position fixed downward (when it is mounted on the CNC coordinate measuring machine).

### Automatic stylus change

If the measurement cannot be achieved by simply changing the probe orientation (such as when it is not possible to make measurements without replacing the normal stylus with one having a different diameter or unique form), automatic stylus change via the stylus change system allows fully automatic measurement to be completed without mid-course interruption. In addition, the use of other probes as advantaged by the probe change system makes it possible to realize full automation in measuring various forms of machined parts (when it is mounted on the CNC coordinate measuring machine).



### Dimensions

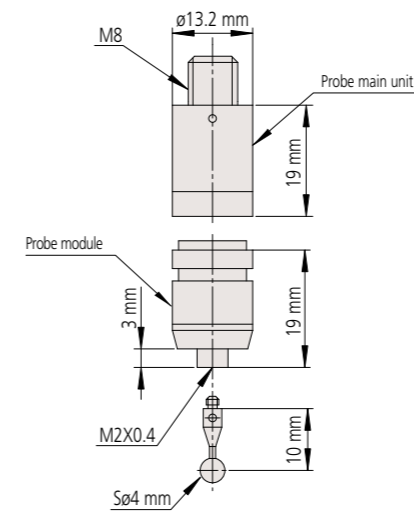

### Set configuration

	Ref. No.	Description	Qty	Specification (use)
Touch-trigger probe TP20 set 06AAV547	1	TP20 probe main unit	1	
	2	Probe module [STANDARD]	1	Measuring force (small)
	3	Probe module [MEDIUM]	1	Measuring force (medium)
	4	Cleaning tool	1	For cleaning stylus module
	5	Single-ended wrench	1	For attaching/detaching probe
	6	Double-ended wrench	2	For attaching/detaching probe
	7	Stylus tool	1	For attaching/detaching stylus
	8	User's Manual	1	
	9	Certificate	1	
				Total mass including package

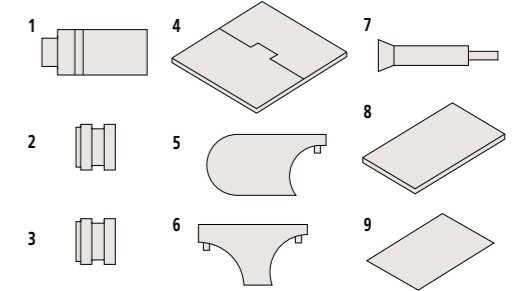

Note: Some items cannot be ordered separately.

### Optional accessories

#### Stylus module

- Standard force module
- Medium force module
- EM1 (Standard force module with extension)
- EM2 (Standard force module with extension)

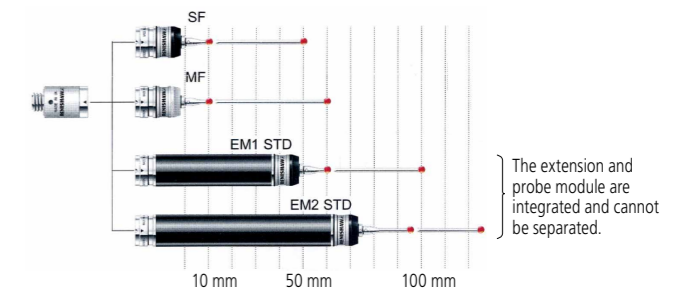

### TP20 Specifications

TP20	Measuring direction	$\pm X, \pm Y, +Z$
	Repeatability ( $2\sigma$ )	0.35 $\mu\text{m}$ or less (with the STANDARD FORCE 10 mm stylus)
	Directionality (XY: 2D)	$\pm 0.8 \mu\text{m}$ or less (with the STANDARD FORCE 10 mm stylus), $\pm 2.5 \mu\text{m}$ or less (with the 50 mm stylus)
	Directionality (XYZ: 3D)	$\pm 1 \mu\text{m}$ or less (with the STANDARD FORCE 10 mm stylus), $\pm 4 \mu\text{m}$ or less (with the 50 mm stylus)
	Required force to generate trigger signal	XY 0.08 N (STANDARD FORCE), with 10 mm stylus 0.1 N (MEDIUM FORCE), with 25 mm stylus
		Z 0.75 N (STANDARD FORCE) 1.9 N (MEDIUM FORCE)
Amount of over-travel	XY $\pm 14^\circ$	
	Z +4.0 mm (STANDARD FORCE) +3.7 mm (MEDIUM FORCE)	
Required force to achieve over-travel	XY 0.2 to 0.3 N (STANDARD FORCE) 0.2 to 0.4 N (MEDIUM FORCE)	
	Z 3.5 N (STANDARD FORCE) 7 N (MEDIUM FORCE)	
Maximum stylus length	50 mm (STANDARD FORCE)* 60 mm (MEDIUM FORCE)*	
Stylus mounting method	M2 thread	
Mass of a single unit	22 g (probe body: 13 g, probe module: 9 g)	
Durability	1,000,000 times	
Probe head	Essential: PH10M/PH10MQ/MIH/PH1	
Applicable models	Manual/CNC coordinate measuring machines	
Note:	Not suitable for use in strong magnetic fields.	
MCR20 (optional)	Probe module replacement accuracy	Repeatability positioning accuracy: 1.0 $\mu\text{m}$ or less (through automatic change), when a 10 mm stylus is used. *2.0 $\mu\text{m}$ or less at a manual replacement: when a 50 mm stylus is used.
	Number of stylus modules that can be mounted	Maximum 6 units

\* Increase in stylus length or stylus mass may deteriorate the accuracy.

### Probe module automatic changing system MCR20

MCR20 set	1	1.3 kg	Accessories	
			• $\phi 2 \times 30$ mm stylus	1
			• Probe module (standard force)	2
			• Mounting kit	1

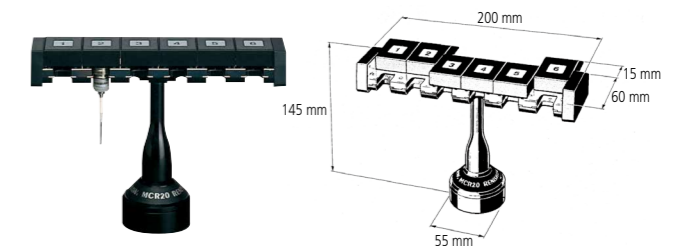

# MH20i Touch-trigger Probe with Manual Probe Head



### Touch-trigger probe with manual probe head

This series of touch-trigger probes has a manually operable probe head for coordinate measuring machines. The probe module has an outside diameter as small as  $\phi 13.2$  mm, which greatly aids in probing complex portions of a workpiece. Other probe modules employing an extension either 50 mm long or 70 mm long are also provided.

### Capable of positioning its orientation

The probe head of the **MH20i** has a structure that not only permits its position (probe orientation) to be manually changed but also provides a maximum of 168 orientations (at a positioning repeatability  $\sigma \leq 1.5 \mu\text{m}$ ). Even for measurement of a complex three-dimensional form that requires repeated changes in the probe orientation, preliminary registration of required positions can eliminate re-calibration after each positional change, thereby broadly improving the measurement efficiency.

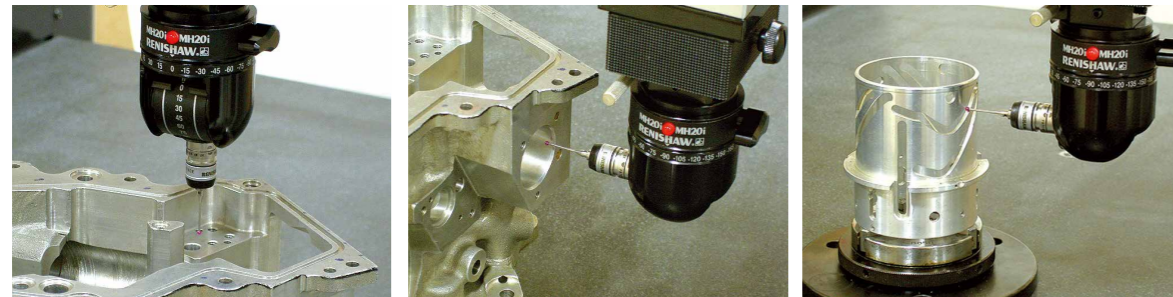

## MH20i Specifications

MH20i	Measuring direction	$\pm X, \pm Y, +Z$
	Position change	Manually for A axis (vertical direction): 0 to 90° (at 15° increments), and for B axis (horizontal direction): $\pm 180^\circ$ (at 15° increments)
	Repeated positioning accuracy	$\sigma \leq 1.5 \mu\text{m}$
	Repeatability ( $2\sigma$ )	0.35 $\mu\text{m}$ or less (with the STANDARD FORCE 10 mm stylus)
	Directionality (XY: 2D)	$\pm 0.8 \mu\text{m}$ or less (with the STANDARD FORCE 10 mm stylus), $\pm 2.5 \mu\text{m}$ or less (with the 50 mm stylus)
	Directionality (XYZ: 3D)	$\pm 1 \mu\text{m}$ or less (with the STANDARD FORCE 10 mm stylus), $\pm 4 \mu\text{m}$ or less (with the 50 mm stylus)
	Required force to generate trigger signal	XY 0.08 N (STANDARD FORCE), with the 10 mm stylus 0.1 N (MEDIUM FORCE), with the 25 mm stylus
		Z 0.75 N (STANDARD FORCE) 1.9 N (MEDIUM FORCE)
	Amount of over-travel	XY $\pm 14^\circ$
		Z +4.0 mm (STANDARD FORCE) +3.7 mm (MEDIUM FORCE)
	Required force to achieve over-travel	XY 0.2 to 0.3 N (STANDARD FORCE) 0.2 to 0.4 N (MEDIUM FORCE)
		Z 3.5 N (STANDARD FORCE) 7 N (MEDIUM FORCE) 10 N (EXTENDED FORCE)
	Maximum stylus length	50 mm (STANDARD FORCE)* 60 mm (MEDIUM FORCE)*
	Stylus mounting method	M2 thread
	Mass of a single probe unit	250 g
	Durability	1,000,000 times
	Probe head	N/A
	Applicable models	Manual/CNC coordinate measuring machines
	Note	Not suitable for use in strong magnetic fields.

\* Increase in stylus length or stylus mass may deteriorate the accuracy.

## Dimensions

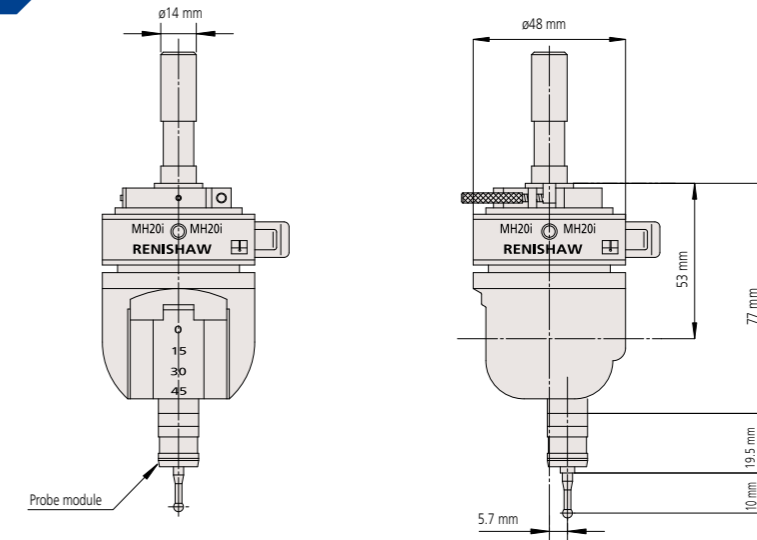

## Set Configuration

Unit	Ref. No.	Description	Qty	Mass (kg)	Remarks
MH20i single unit Code No. 06ABN436	1	MH20i	1	0.25	
	2	Probe module	1	0.01	STANDARD TYPE
	3	Cleaning tool	1	0.05	For cleaning the stylus module
	4	MS2-stylus tool	1	0.003	For attaching/detaching the stylus
MH20i set Code No. 06ABN470	5	Positioning shank	1	0.15	
	6	Stylus	1	0.001	$\phi 4 \times 10$ (standard stylus)
	7	Allen key (2 mm)	1	0.001	
	8	Allen key (3 mm)	1	0.001	
	9	User's Manual	1	0.1	

Note: Some items cannot be ordered separately.

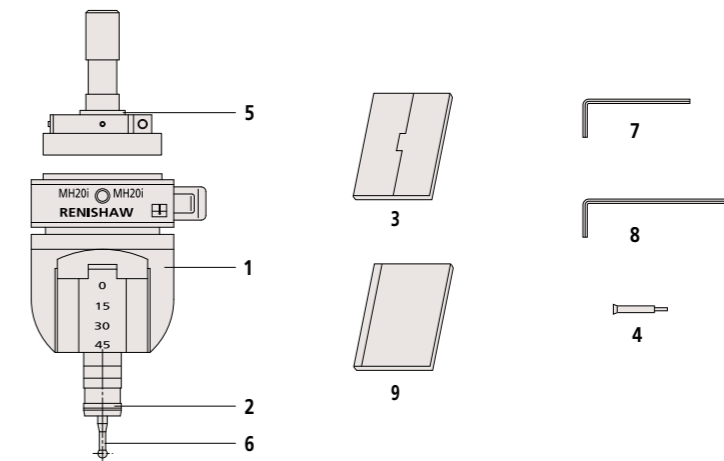

## Optional accessories Stylus modules

- Standard force module
- Medium force module
- EM1 (Standard force module with extension)
- EM2 (Standard force module with extension)

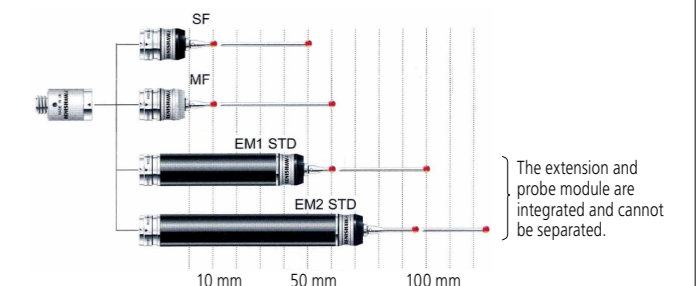

The extension and probe module are integrated and cannot be separated.

# PH10M/PH10MQ Motorized Probe Head



### Enhancing measurement efficiency through automatic probe indexing

This probe head can automatically control the position of a probe attached at the end. Automatic position change can be performed by simply specifying the angle through the supplied control box or the dedicated software during teaching and setting it to recall the position from memory.

Moreover, this automatic position change allows for measurement to be completed in much less time than the automatic stylus change method, reducing the total number of man-hours required to perform measurement with the coordinate measuring machine.

### High-accuracy indexing to 720 positions

Since the PH10M/PH10MQ can set the attached probe to a maximum of 720 different positions, even one stylus can function as if 720 styli are attached. In addition, since this probe head has a repeatability to the same position as high as  $2\sigma \leq 0.4 \mu\text{m}$ , it does not require re-calibration for measurement in which the same position must be repeatedly called.

### Possible to mount various kinds of probe

This head can mount various probes including, but not limited to, a touch-trigger probe, scanning probe, vision probe, laser probe, and thread depth measuring probe. Furthermore, these probes can be easily interchanged by means of the probe changer (optional), which enables fully automatic measurement on a wide range of measurement objects.

\* Note that some probes are not compatible with this automatic probe change.



## PH10M/PH10MQ Specifications

PH10M/PH10MQ	Position change	Horizontal direction	$\pm 180^\circ$ (at $7.5^\circ$ increments, 48 positions)
		Vertical direction	0 to $105^\circ$ (at $7.5^\circ$ increments, 15 positions)
	Repeated positioning accuracy	$2\sigma \leq 0.4 \mu\text{m}$ (when the PAA1+TP20+L10 mm stylus is used.)	
	Extension	PEM1, PEM2, PEM3, PAA1, PAA2, PAA3 More than one extension cannot be joined for use. However, combined use of PAA+PECF1, PAA1+PECF2, and PAA1+PECF3 are permitted. Use on an extension is not permitted for the SurfaceMeasure/QVP.	
	Applicable models	CNC coordinate measuring machines	
	Durability	1,000,000 times	

### PH10M dimensions

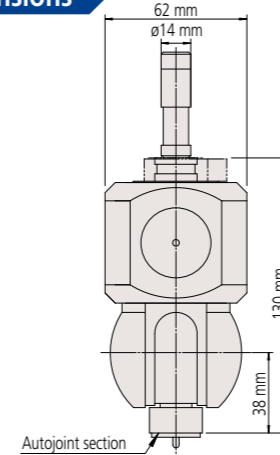

### PH10MQ dimensions

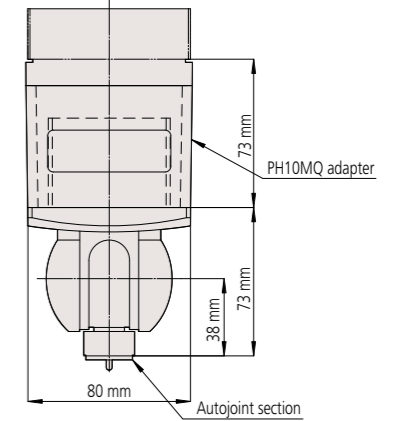

## Extensions

Model	Dimension	Remarks
PAA1	32 mm	For TP200/TP20
PECF1	50 mm	For TP200/TP20
PECF2	100 mm	For TP200/TP20
PECF3	200 mm	For TP200/TP20
PAA3	300 mm	For TP200/TP20
PEM1	50 mm	For SP25M/TP7M
PEM2	100 mm	For SP25M/TP7M
PEM3	200 mm	For TP7M

## Set configuration

No.	Description	Qty	Remarks
1	PH10M head set	1	
	PH10M head		
	Joint key S10		
	Allen key (nominal 1.5)		
2	PH10MQ head set	1	
	PH10MQ head		
	Joint key S10		
3	HCU-1	1	Controller for positioning the probe head
	PHC10-2 (RS232C)	1	Interface with the machine-side CPU (for error display)
4	PHC10-2 (RS232C)	1	Interface with the machine-side CPU (for error display)
5	PAA1	1	Adapter for mounting the TP200 onto the PH10M
6	User's Manual	1	User's Manual for PH10M head

Note: Some items cannot be ordered separately.

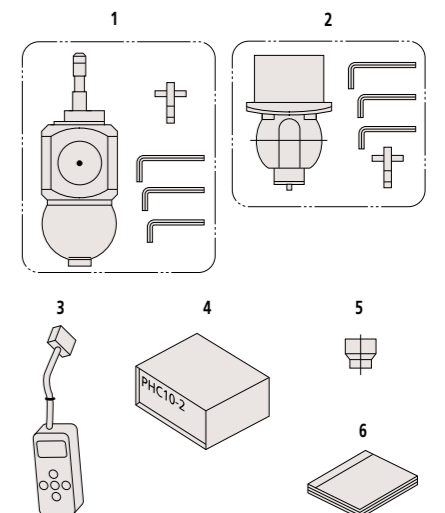

# PH1 Manual Probe Head



### Manual probe head

Manual probe head for use with the TP200 and TP20.

### Easy position change

The operator can change the probe orientation by hand.

### Extension

It is possible to insert a probe extension that is a maximum of 200 mm long.



## PH1 Specifications

PH1	Position change	Horizontal direction	360° (at 15° increments) Possible in a non-stop manner, if the head is rotated along with the $\phi 14$ mm shank unit.
		Vertical direction	$\pm 115^\circ$ (non-step)
	Mountable probe	TP200, TP20	
	Extension	PECF1, PECF2, PECF3	
	Applicable models	Manual/CNC coordinate measuring machines	

## Dimensions

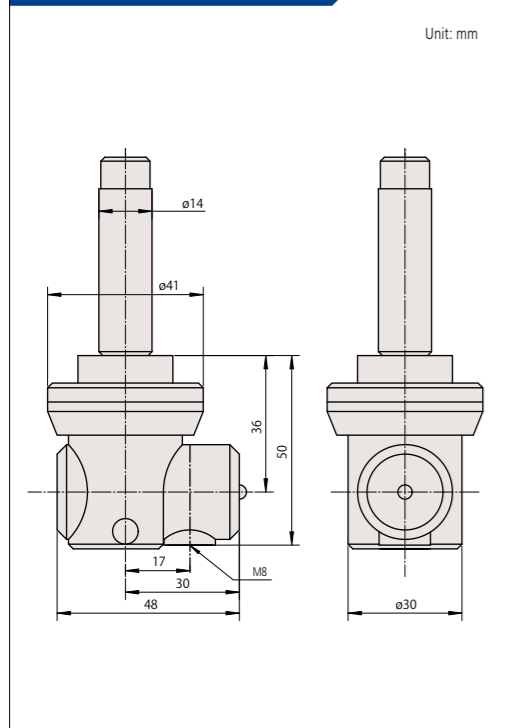

## Optional accessories Extensions

PECF1	
PECF2	
PECF3	



An example connection of PECF3

# REVO-2 High-speed 5-axis Control Scanning Head



### Ultra-high-speed 5-axis scanning

This scanning head allows ultra-high-speed scanning at up to 500 mm/s. With simultaneous control of a total of 5 axes (3 axes <X, Y and Z> on a CMM and 2 axes <A and B> on REVO-2), the CMM can perform non-step scanning of complex forms on a workpiece. Various measurement operations specific to REVO-2 are also available. The use of a rotary encoder allows unlimited angle positioning (at a resolution of 0.08 sec). This enables easy access to a complicated workpiece, leading to a reduction of programming and measuring time periods. The REVO-2 probe is only available on the dedicated CRYSTA-Apex EX 1200R series.



## REVO-2 Specifications

REVO-2	Rotation angle (Pitch angle)	Vertical (A-axis)	$-5^\circ \sim +120^\circ$ (0.08 sec)
		Horizontal (B-axis)	$\infty$ (0.08 sec)
	Maximum stylus length		500 mm (Distance from probe rotation center to stylus tip)*

\* An increase in the length and mass of a stylus may reduce the accuracy.

# PH20 5-axis Control Touch-trigger Probe System



### Effective measurement of a complex workpiece using stylus movement

The PH20 head can position a touch-trigger probe at any angle, allowing unique "head touch" probing. This system has the advantage of measuring tilted surfaces and small, deep holes. There is no fear of interference from the stylus shank during measurement of a deep hole.

5-axis operation reduces the time required for probe rotational movements and supports "head touch" operation for quick point measurement.

The system also supports the module changer using TP20 standard modules.

By combining optional software, a measurement program can be created on a PC using 3D CAD data.



## PH20 Specifications

PH20	Rotation angle (Pitch angle)	Vertical (A-axis)	$-115^\circ \sim +115^\circ$ (0.08 sec)
		Horizontal (B-axis)	$\infty$ (0.08 sec)
	Maximum stylus length		50 mm*

\* An increase in the length and mass of a stylus may deteriorate the accuracy.



# ACR3 Automatic Probe Changer



### The need for an automatic probe changer

The **ACR3** is an automatic probe changer for use with the **PH10M/PH10MQ**. It is essential for fully automatic measurements where the currently employed probe does not have the capability of automatic stylus change but the stylus diameter or length must be occasionally changed, and where the contact-type probe and non-contact type probe are switched as required.

### Dimensions

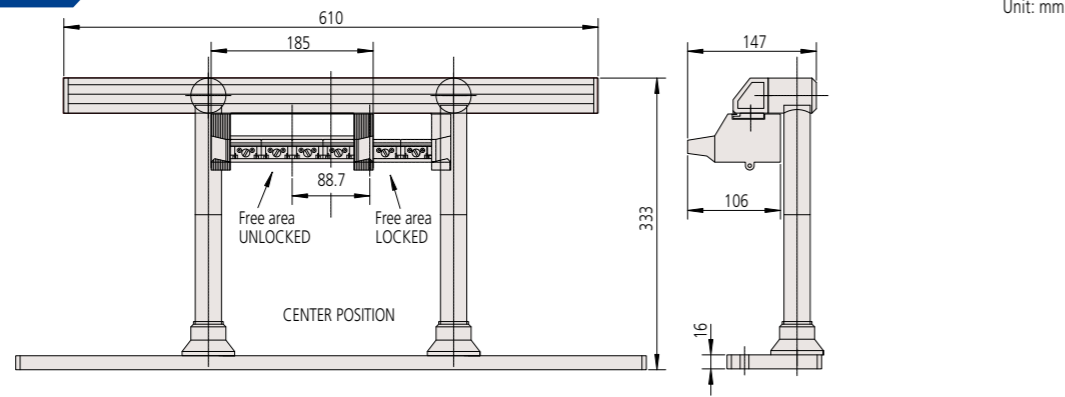

### Set configuration

Unit	Ref. No.	Description	Qty	Remarks
ACR3 4-port system	1	ACR3	1	4-port rack
	2	MRS KIT2	1	Rack base
	3	Auxiliary plate	1	For fixture
	4	ACR3 attachment	1	Attachment
	5	User's Manual	1	
	6	Control ROM	1	Adaptive to ACR3
ACR3 8-port system	1	ACR3	2	4-port rack
	2	MRS KIT2	1	Rack base
	3	Auxiliary plate	1	For fixture
	4	ACR3 attachment	1	Attachment
	5	User's Manual	1	
	6	Control ROM	1	Adaptive to ACR3

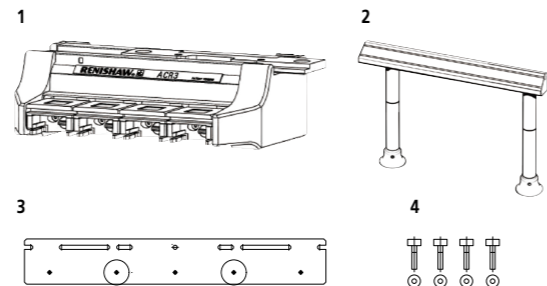

# Rotary Tables for CNC CMM



These optional rotary tables allow highly-accurate and efficient measurements of workpieces like rotationally symmetrical parts (gears, impellers and cylindrical cams). When used with a scanning probe, synchronized scanning measurements can be performed, enabling various contour measurements and advanced measurements.

### MRT240

Compact and light weight but capable of supporting a workpiece of up to 40 kg. Can also be used with shop-floor type CNC coordinate measuring machine, MISTAR555.

### MRT320

A  $\phi 60$  mm through hole on the center of the table allows measurements of long axial workpieces like long drive shafts.

### Q5600/Q5800

Suitable for measurements of large workpieces.

### Specifications

Model		MRT240	MRT320	Q5600	Q5800
Dimensions [mm]	Depth	327	470	1000	1200
	Width	250	400	720	920
	Height	105	150	160	
Table diameter [mm]		240	320	600	800
Mass [kg]		20	120	370	530
Max. load [kg]		40	100	1700	3000
Accuracy	indexing accuracy [°]	±0.00019		0.0006	
Max. drive speed [rpm]		6	9	5	4

### Customized special applications

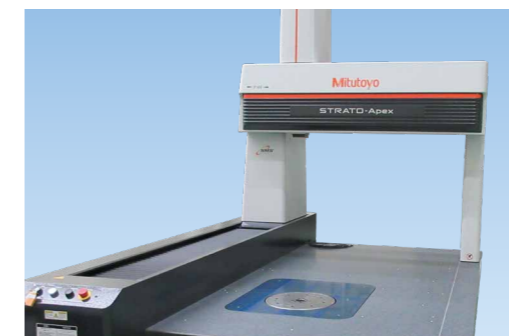

Embedded in measuring table



Air suspension

# Quick guide to styli

The choice of stylus has an important effect on the accuracy of measurement obtainable from a CMM. Here is a quick guide on how to select a stylus.

The stylus is the part of a probe that makes contact with a workpiece, generally consisting of a stem and a ball tip. The probe functions by bringing the ball into contact with a workpiece to acquire a measurement from the resulting signal. The form and dimensions of a stylus need to be selected depending on the workpiece. In any case, it is important that a stylus has high rigidity and its tip shape is a practically perfect sphere.

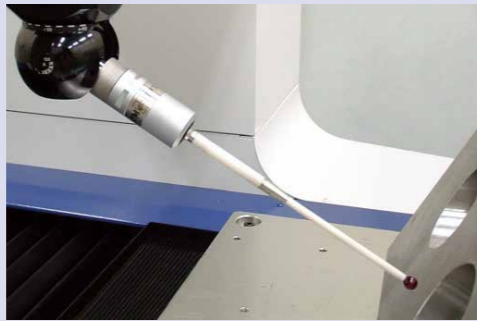

## ■ Selection of a stylus

It is recommended that a stylus be selected on the basis of the following factors to ensure the high accuracy of measurement.

### 1. Choose the shortest stylus possible.

The longer a stylus, the more it will flex, and lower accuracy will result. We recommend using the shortest possible stylus for measurement, regardless of the configuration of the stylus.

### 2. Reduce the number of joints wherever possible.

The combination of styli and use of extensions will increase the possibility flexure. We recommend using as few parts as possible to make up the stylus.

### 3. Use a ball tip as large as possible.

The use of a larger ball increases the clearance between the ball and stem, thus reducing the possibility of contact between the stem and workpiece (shanking). A larger ball also reduces the influence of the surface finish of a workpiece on measurement accuracy.

## ■ Material

A stylus uses an appropriate material for its shaft, ball and other accessories according to the application. The following introduces the features and merits of commonly used materials.

### 1. Stem

To minimize flexure, the stem needs to be as stiff as possible. Mitutoyo offers the following materials:

 ■ Tungsten carbide  
This material provides excellent rigidity for small stem diameters, thus being optimal for most standard applications. Consideration should be given to the stylus mass in the case of large stem diameter and long stylus length.

 ■ Stainless steel  
Non-magnetic stainless steel stems offer the best stiffness to mass ratio.

 ■ Ceramic  
Because it is light and has the same level of rigidity as stainless steel, ceramic is mainly used with a stylus with a large ball size and a long axis. It has excellent thermal stability and is not affected by the temperature environment, thereby allowing higher accuracy measurement.

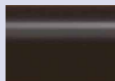
 ■ Carbon fiber  
Carbon fiber is a material appropriate for long styli since the mass of a carbon fiber stylus is approximately 20% of that of a carbide stylus. Thanks to excellent thermal stability, a carbon fiber stylus is little affected by the operating environment.

## 2. Ball Tip

Selection of the most suitable ball tip material involves taking the measuring procedure and workpiece material into account.

 ■ Ruby  
A ruby ball provides a particularly hard, smooth surface, featuring high compressive strength and excellent mechanical wiping. Ruby is appropriate as a ball material for scanning diverse workpieces, but may cause abrasion during the scanning measurement of aluminum and cast iron. When measuring aluminum and cast iron, it is advisable to use other ball materials as listed below.

 ■ Silicon nitride  
Silicon nitride, which is similar to ruby, is a ceramic material that provides high hardness and strong resistance to abrasion. Since silicon nitride will not fuse with aluminum, it will not cause adhesive wear like ruby. Since silicon nitride will not fuse with aluminum, it will not cause adhesive wear like ruby. However, it is recommended that a silicon nitride ball be used only for aluminum workpieces due to a marked susceptibility to abrasion on steel surfaces.

 ■ Zirconia  
Zirconia is a ceramic material that demonstrates a particularly outstanding hardness and has hardness and abrasion characteristics equivalent to a ruby. It is ideal for scanning cast iron parts.

## ■ Calibration

Even if a stylus appropriate for a workpiece is selected, an accurate measurement result will not be obtained unless the probe to be used is calibrated prior to measurement, which involves probing a master reference sphere in a defined sequence so that the CMM software can establish the ball tip and probe/stylus characteristics.

■ Calibration mechanism  
The CMM calculates the center position and diameter of each stylus ball using the specific probe calibration program. This program uses CMM measurements made of the reference sphere with each configured stylus ball to determine the true diameters of the balls and stores the measured data in the software. The precise diameter of the reference sphere is known from a previous calibration measurement and is also stored for use in the calculations. As a workpiece may be measured from every direction, a stylus is calibrated with measurements at multiple points on the reference sphere. A scanning system needs to obtain a large number of points for calibration. With these procedures observed, the effective diameter for each stylus ball and the center positions of the stylus balls in the machine coordinate system are set to enable accurate measurement.

## ■ Notes on using styli

- Inaccuracies can occur depending on the stylus length and mass and the drive speed and acceleration of the probe. Due consideration should be given to the type of probe when setting measuring speed for long and/or heavy styli for scanning measurements.
- A disk stylus consists of the center section of a sphere and is used to measure edges and undercuts on a workpiece. This type of stylus is actually used only for X- and Y-direction measurement due to its shape. It cannot be used for Z-direction measurement. Also, this stylus must be used in conjunction with a stylus changer.
- There are restrictions on the use of a cylinder stylus, again because of its shape.
- For details about restrictions, contact a Mitutoyo sales office.
- Styli are classified in M2 to M5 series, which refers to the fixing thread size of a probe.  
The use of a conversion adapter, etc. may allow a stylus with a different thread size to be mounted. In this case, refer to the instruction manual of the probe on which to mount the stylus to select the stylus configuration compatible with the probe specification. Contact your local Mitutoyo sales office if you have any questions about the mounting method.

Product Identification on Styli for Coordinate Measuring Machines

From each Mitutoyo styli the approximate form can be identified (see below).

1 Ball styli

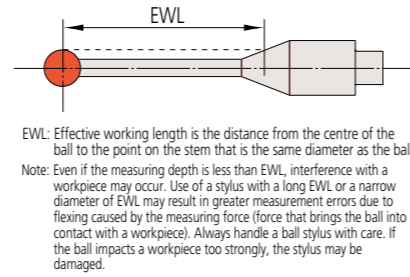
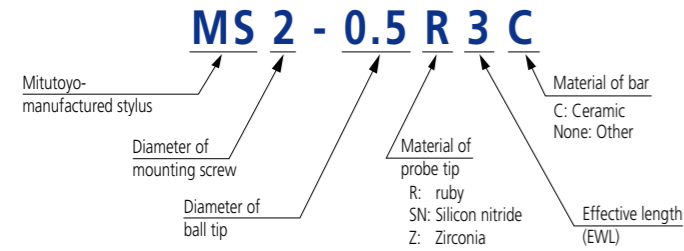

2 Cylindrical styli

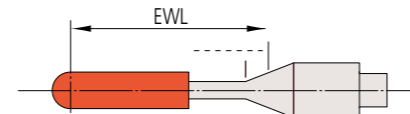
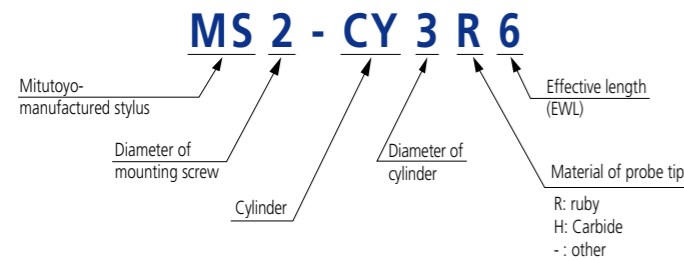

3 Disc styli

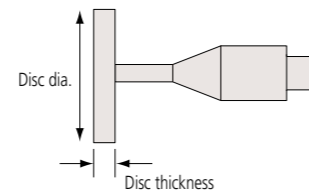
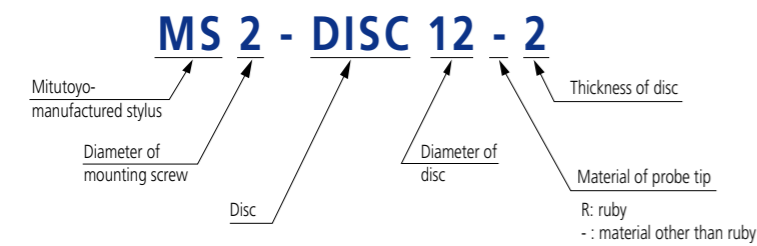

4 Cross-styli

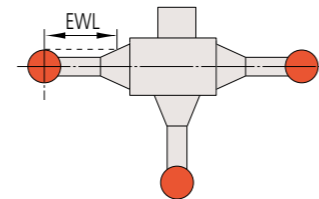
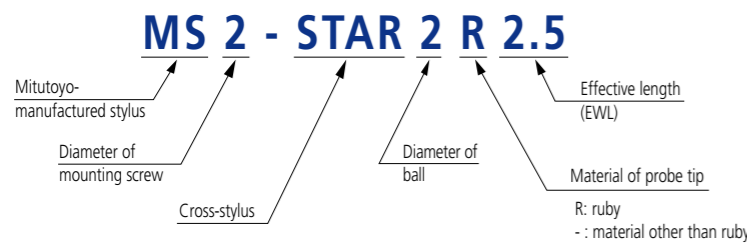

5 Other accessories

- ① Point stylus MS2-PO ("H" will be added when the probe tip is carbide.)
- ② Extension MS2-EXT10 (the figure at the end represents the length. "G" is appended if the bar is carbon fiber, and "C" is appended if the bar is ceramic.)
- ③ Stylus knuckle MS2-stylus knuckle (an adapter for turning the stylus to the optional angle.)
- ④ Stylus center MS-stylus center (an adapter to allow the styli to be mounted so they can be oriented in directions crossing each other.)

Stylus (Mounting Thread M2)

Code No.	06ABN751
Description	MS2-0.3R2

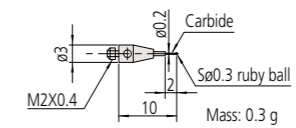

- Use with a measuring force 0.4 N or less.
- Cannot be mounted on TP200.
- This stylus may have a short life compared with normal styli.
- The use of a ceramic master ball (high precision type) Sφ10 mm is recommended.

Code No.	06ABN752	06AFG320	06AFG391
Description	MS2-0.5R3	MS2-0.5SN3	MS2-0.5Z3
Material of probe tip	Ruby	Silicon nitride	Zirconia

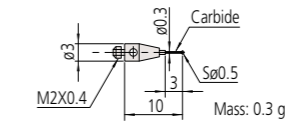

- This stylus may have a short life compared with normal styli.
- Not recommended for mounting on TP200, otherwise an input error may result.
- The use of a ceramic master ball (high precision type) Sφ10 mm is recommended.

Code No.	06ABN753	06AFG392
Description	MS2-0.7R4	MS2-0.7Z4
Material of probe tip	Ruby	Zirconia

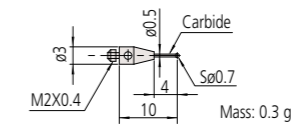

- This stylus may have a short life compared with normal styli.
- The use of a ceramic master ball (high precision type) Sφ10 mm is recommended.

Code No.	06ABN754	06AFG321	06AFG393
Description	MS2-1R4.5	MS2-1SN4.5	MS2-1Z4.5
Material of probe tip	Ruby	Silicon nitride	Zirconia

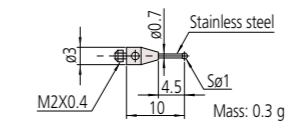

- This stylus may have a short life compared with normal styli.

Code No.	06ABN755	06AFG322	06AFG394
Description	MS2-1R7	MS2-1SN7	MS2-1Z7
Material of probe tip	Ruby	Silicon nitride	Zirconia

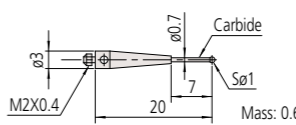

- This stylus may have a short life compared with normal styli.

Code No.	06ABN756	06AFG323	06AFG395
Description	MS2-1R12.5	MS2-1SN12.5	MS2-1Z12.5
Material of probe tip	Ruby	Silicon nitride	Zirconia

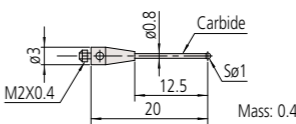

- This stylus may have a short life compared with normal styli.

Code No.	06ABN757	06AFG324	06AFG396
Description	MS2-1R20.5	MS2-1SN20.5	MS2-1Z20.5
Material of probe tip	Ruby	Silicon nitride	Zirconia

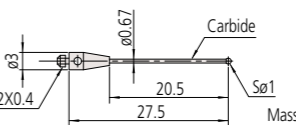

- This stylus may have a short life compared with normal styli.

Code No.	06ABF409
Description	MS2-1R37

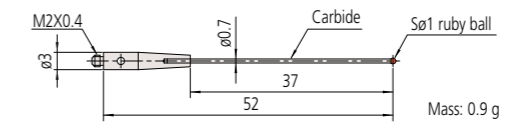

- Cannot be mounted on TP200.\* Not recommended for mounting on TP20, otherwise an input error may result.

Code No.	06ABN758	06AFG325	06AFG397
Description	MS2-1.5R4.5	MS2-1.5SN4.5	MS2-1.5Z4.5
Material of probe tip	Ruby	Silicon nitride	Zirconia

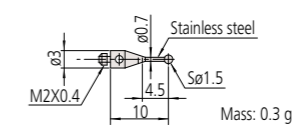

- This stylus may have a short life compared with normal styli.

Code No.	06ABN759	06AFG326	06AFG398
Description	MS2-1.5R12.5	MS2-1.5SN12.5	MS2-1.5Z12.5
Material of probe tip	Ruby	Silicon nitride	Zirconia

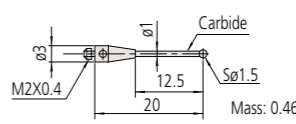

- This stylus may have a short life compared with normal styli.

Code No.	06ABN760	06AFG327	06AFG399
Description	MS2-1.5R22.5	MS2-1.5SN22.5	MS2-1.5Z22.5
Material of probe tip	Ruby	Silicon nitride	Zirconia

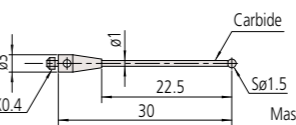

- This stylus may have a short life compared with normal styli.

Code No.	06ABN761	06AFG328	06AFG400
Description	MS2-2R6	MS2-2SN6	MS2-2Z6
Material of probe tip	Ruby	Silicon nitride	Zirconia

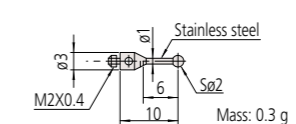

- This stylus may have a short life compared with normal styli.

Note: For a stylus longer than 30 mm, select a product with its axis made from carbon fiber or ceramic.

Code No.	06ABN762	06AFG329	06AFG401
Description	MS2-2R14	MS2-2SN14	MS2-2Z14
Material of probe tip	Ruby	Silicon nitride	Zirconia

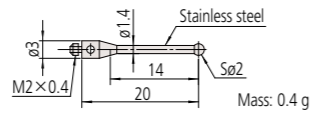

Code No.	06ABN763	06AFG330	06AFG402
Description	MS2-2R22.5	MS2-2SN22.5	MS2-2Z22.5
Material of probe tip	Ruby	Silicon nitride	Zirconia

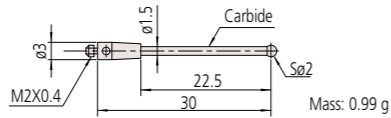

Code No.	06ABN764	06AFG342	06AFG403
Description	MS2-2R32.5	MS2-2SN32.5	MS2-2Z32.5
Material of probe tip	Ruby	Silicon nitride	Zirconia

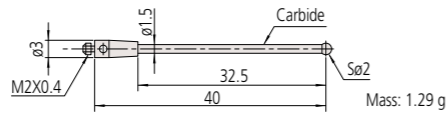

Code No.	06ABF406
Description	MS2-2R52

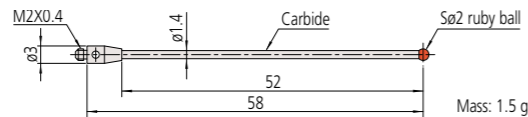

• Cannot be mounted on TP200. \* Not recommended for mounting on TP20, otherwise an input error may result.

Code No.	06ABN765	06AFG343	06AFG404
Description	MS2-2.5R6	MS2-2.5SN6	MS2-2.5Z6
Material of probe tip	Ruby	Silicon nitride	Zirconia

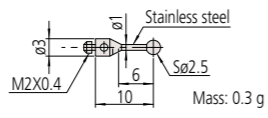

Code No.	06ABN766	06AFG344	06AFG405
Description	MS2-2.5R16.4	MS2-2.5SN16.4	MS2-2.5Z16.4
Material of probe tip	Ruby	Silicon nitride	Zirconia

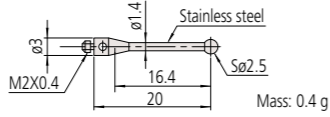

Code No.	06ABN767	06AFG345	06AFG406
Description	MS2-2.5R22.5	MS2-2.5SN22.5	MS2-2.5Z22.5
Material of probe tip	Ruby	Silicon nitride	Zirconia

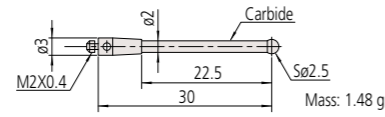

Code No.	06ABN768	06AFG346	06AFG407
Description	MS2-2.5R32.5	MS2-2.5SN32.5	MS2-2.5Z32.5
Material of probe tip	Ruby	Silicon nitride	Zirconia

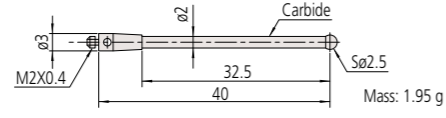

Code No.	06ABN769	06AFG347	06AFG408
Description	MS2-3R7.5	MS2-3SN7.5	MS2-3Z7.5
Material of probe tip	Ruby	Silicon nitride	Zirconia

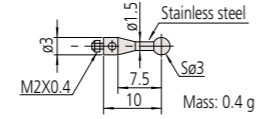

Code No.	06ABN770	06AFG348	06AFG409
Description	MS2-3R17.5	MS2-3SN17.5	MS2-3Z17.5
Material of probe tip	Ruby	Silicon nitride	Zirconia

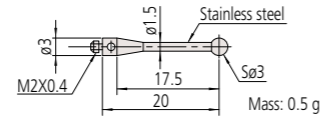

Code No.	06ABN771	06AFG349	06AFG410
Description	MS2-3R27.5	MS2-3SN27.5	MS2-3Z27.5
Material of probe tip	Ruby	Silicon nitride	Zirconia

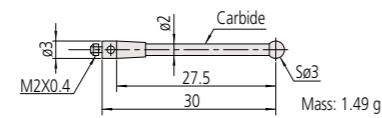

Code No.	06ABN772	06AFG350	06AFG411
Description	MS2-3R37.5	MS2-3SN37.5	MS2-3Z37.5
Material of probe tip	Ruby	Silicon nitride	Zirconia

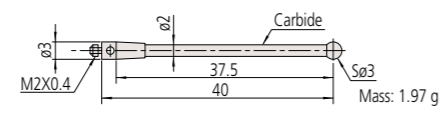

Code No.	06ABN773	06AFG351	06AFG412
Description	MS2-3R47.5	MS2-3SN47.5	MS2-3Z47.5
Material of probe tip	Ruby	Silicon nitride	Zirconia

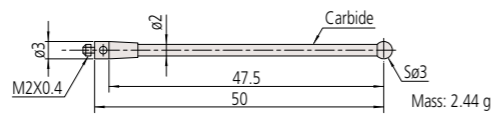

• Not recommended for mounting on TP20, otherwise an input error may result.

Note: For a stylus longer than 30 mm, select a product with its axis made from carbon fiber or ceramic.

Code No.	06ABF402
Description	MS2-3R64

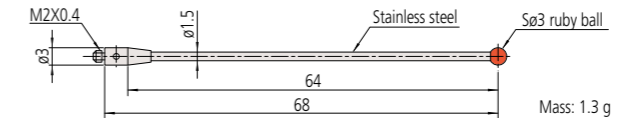

• Not recommended for mounting on TP20, otherwise an input error may result.

Code No.	06ABF405
Description	MS2-3R68.5C

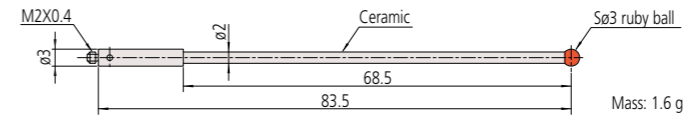

• Cannot be mounted on TP200. Not recommended for mounting on TP20, otherwise an input error may result.

Code No.	06ABN774	06AFG352	06AFG413
Description	MS2-4R10	MS2-4SN10	MS2-4Z10
Material of probe tip	Ruby	Silicon nitride	Zirconia

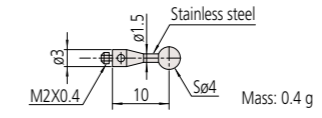

Code No.	06AFZ463
Description	MS2-4R12.15

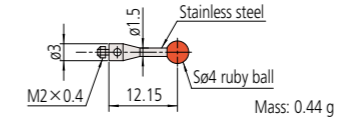

Code No.	06ABN775	06AFG353	06AFG414
Description	MS2-4R20	MS2-4SN20	MS2-4Z20
Material of probe tip	Ruby	Silicon nitride	Zirconia

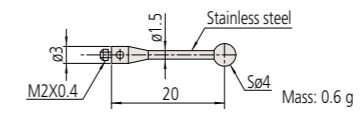

Code No.	06ABN776	06AFG354	06AFG415
Description	MS2-4R30	MS2-4SN30	MS2-4Z30
Material of probe tip	Ruby	Silicon nitride	Zirconia

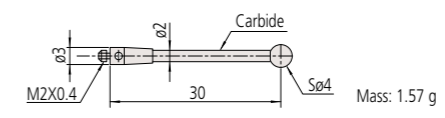

Code No.	06ABN777	06AFG355	06AFG416
Description	MS2-4R40	MS2-4SN40	MS2-4Z40
Material of probe tip	Ruby	Silicon nitride	Zirconia

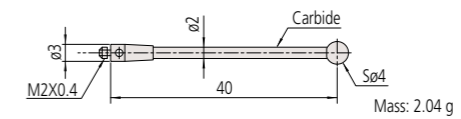

Code No.	06ABN778	06AFG356	06AFG417
Description	MS2-4R50	MS2-4SN50	MS2-4Z50
Material of probe tip	Ruby	Silicon nitride	Zirconia

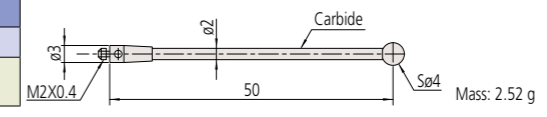

• Not recommended for mounting on TP 20, otherwise an input error may result.

Code No.	06ABN779	06AFG357	06AFG418
Description	MS2-4R50C	MS2-4SN50C	MS2-4Z50C
Material of probe tip	Ruby	Silicon nitride	Zirconia

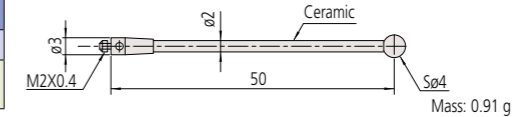

Code No.	06ABQ341	06AFG358	06AFG419
Description	MS2-4R50.5G	MS2-4SN50.5G	MS2-4Z50.5G
Material of probe tip	Ruby	Silicon nitride	Zirconia

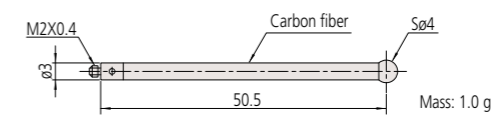

Code No.	06ABF404
Description	MS2-4R68

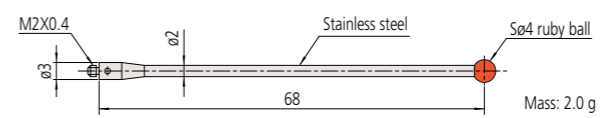

• Not recommended for mounting on TP20, otherwise an input error may result.

Code No.	06ABF410
Description	MS2-4R98C

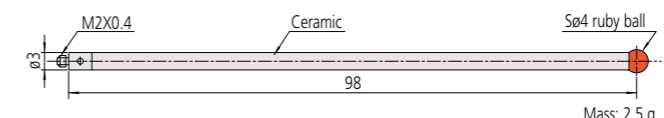

• Cannot be mounted on TP200. Not recommended for mounting on TP20, otherwise an input error may result.

Code No.	06ABN780	06AFG359	06AFG420
Description	MS2-5R10	MS2-5SN10	MS2-5Z10
Material of probe tip	Ruby	Silicon nitride	Zirconia

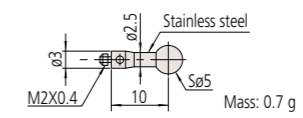

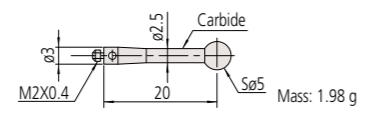
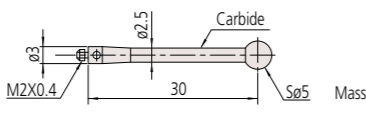
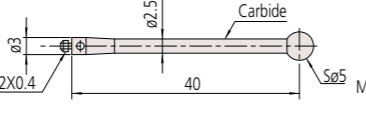
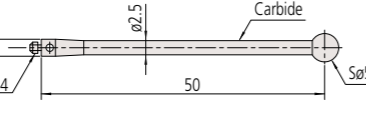
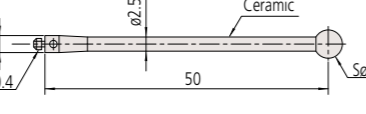
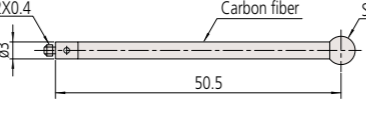
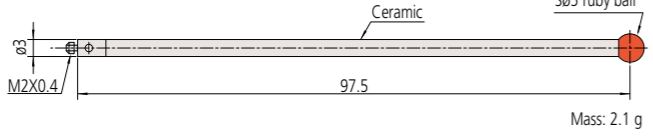
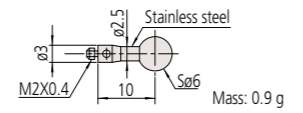
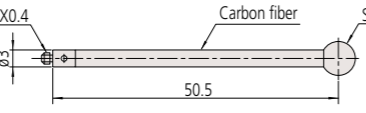
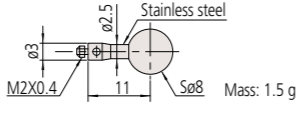

Note: For a stylus longer than 30 mm, select a product with its axis made from carbon fiber or ceramic.

Code No.	06ABN781	06AFG360	06AFG421	 <p>Carbide Mass: 1.98 g</p>
Description	MS2-5R20	MS2-5SN20	MS2-5Z20	
Material of probe tip	Ruby	Silicon nitride	Zirconia	
Code No.	06ABN782	06AFG361	06AFG422	 <p>Carbide Mass: 2.57 g</p>
Description	MS2-5R30	MS2-5SN30	MS2-5Z30	
Material of probe tip	Ruby	Silicon nitride	Zirconia	
Code No.	06ABN783	06AFG362	06AFG423	 <p>Carbide Mass: 3.17 g</p>
Description	MS2-5R40	MS2-5SN40	MS2-5Z40	
Material of probe tip	Ruby	Silicon nitride	Zirconia	
Code No.	06ABN784	06AFG363	06AFG424	 <p>Carbide Mass: 3.75 g</p>
Description	MS2-5R50	MS2-5SN50	MS2-5Z50	
Material of probe tip	Ruby	Silicon nitride	Zirconia	• Not recommended for mounting on TP20, otherwise an input error may result.
Code No.	06ABN785	06AFG364	06AFG425	 <p>Ceramic Mass: 1.0 g</p>
Description	MS2-5R50C	MS2-5SN50C	MS2-5Z50C	
Material of probe tip	Ruby	Silicon nitride	Zirconia	
Code No.	06ABQ342	06AFG365	06AFG426	 <p>Carbon fiber Mass: 1.1 g</p>
Description	MS2-5R50.5G	MS2-5SN50.5G	MS2-5Z50.5G	
Material of probe tip	Ruby	Silicon nitride	Zirconia	
Code No.	06ABF411			 <p>Ceramic Sø5 ruby ball Mass: 2.1 g</p>
Description	MS2-5R97.5C			
				• Cannot be mounted on TP200. Not recommended for mounting on TP20, otherwise an input error may result.
Code No.	06ABN786	06AFG366	06AFG427	 <p>Stainless steel Mass: 0.9 g</p>
Description	MS2-6R10	MS2-6SN10	MS2-6Z10	
Material of probe tip	Ruby	Silicon nitride	Zirconia	
Code No.	06ABN787	06AFG367	06AFG428	 <p>Carbon fiber Mass: 1.2 g</p>
Description	MS2-6R50.5G	MS2-6SN50.5G	MS2-6Z50.5G	
Material of probe tip	Ruby	Silicon nitride	Zirconia	
Code No.	06ABN788	06AFG368	06AFG429	 <p>Stainless steel Mass: 1.5 g</p>
Description	MS2-8R11	MS2-8SN11	MS2-8Z11	
Material of probe tip	Ruby	Silicon nitride	Zirconia	

Note: For a stylus longer than 30 mm, select a product with its axis made from carbon fiber or ceramic.

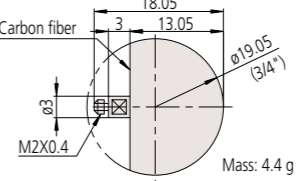
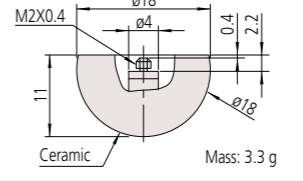
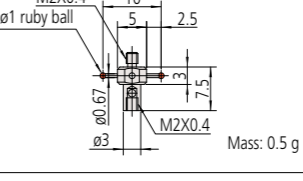
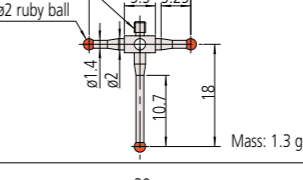
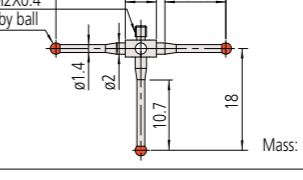
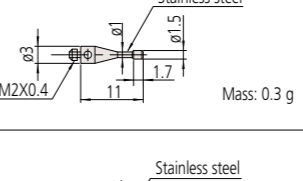
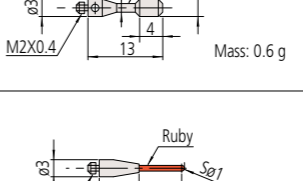
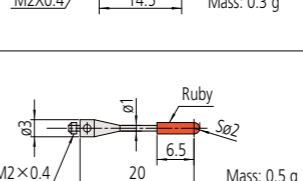
### ■ Stylus (Mounting thread M2)

Code No.	135399	 <p>Carbon fiber Mass: 4.4 g</p>
Description	MS2-19.05C 3/4inch	
Code No.	160225	 <p>Ceramic Mass: 3.3 g</p>
Description	MS2-18C	
Code No.	06ABN795	 <p>Sø1 ruby ball Mass: 0.5 g</p>
Description	MS2-STAR1R2.5	
Code No.	06ABN796	 <p>Sø2 ruby ball Mass: 1.3 g</p>
Description	MS2-STAR2R5.25	
Code No.	06ABN797	 <p>Sø2 ruby ball Mass: 1.8 g</p>
Description	MS2-STAR2R10.75	
Code No.	06ABN789	 <p>Stainless steel Mass: 0.3 g</p>
Description	MS2-CY1.5-1.7	
Code No.	06ABN790	 <p>Stainless steel Mass: 0.6 g</p>
Description	MS2-CY3-4	
Code No.	06ABN791	 <p>Ruby Mass: 0.3 g</p>
Description	MS2-CY1R7.5	
Code No.	06ABN792	 <p>Ruby Mass: 0.5 g</p>
Description	MS2-CY2R6.5	
		• The use may be restricted depending on the application. Please contact your local Mitutoyo sales office.
		• The use may be restricted depending on the application. Please contact your local Mitutoyo sales office.
		• The use may be restricted depending on the application. Please contact your local Mitutoyo sales office.
		• The use may be restricted depending on the application. Please contact your local Mitutoyo sales office.

Code No.	06ABN793
Description	MS2-CY2H31

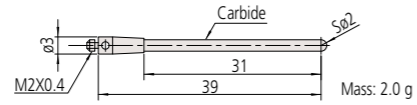

- Cannot be mounted on TP200.\*
- The use may be restricted depending on the application. Please contact your local Mitutoyo sales office.

Code No.	06ABN794
Description	MS2-CY4R8.5

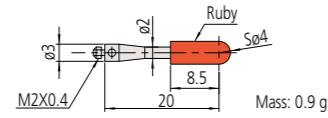

- The use may be restricted depending on the application. Please contact your local Mitutoyo sales office.

Code No.	06ABN799
Description	MS2-PO

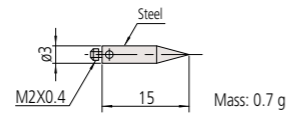

Code No.	06ABN800
Description	MS2-PO-H

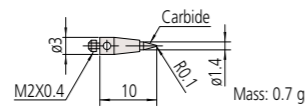

Code No.	160214
Description	MS2-DISC6R-2

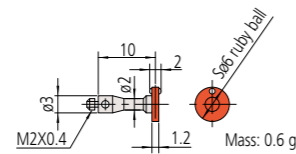

- The use may be restricted depending on the application. Please contact your local Mitutoyo sales office.

Code No.	06AAL516
Description	MS2-DISC18-2.5

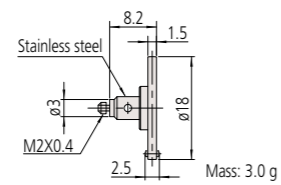

- The use may be restricted depending on the application. Please contact your local Mitutoyo sales office.

Code No.	160215
Description	MS2-DISC18-3

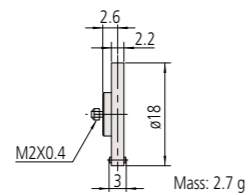

- The use may be restricted depending on the application. Please contact your local Mitutoyo sales office.

Code No.	06AAL517
Description	MS2-DISC25-2.5

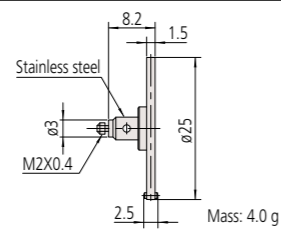

- The use may be restricted depending on the application. Please contact your local Mitutoyo sales office.

Code No.	160226
Description	MS2-DISC25-3

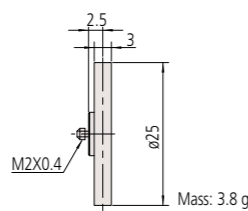

- The use may be restricted depending on the application. Please contact your local Mitutoyo sales office.

\* For a stylus longer than 30 mm, select a product with its axis made from carbon fiber or ceramic.

## ■ Stylus (Mounting thread M2)

Code No.	06ABP853
Description	MS2-EXT5

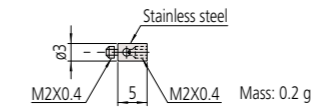

Code No.	06ABN804
Description	MS2-EXT10

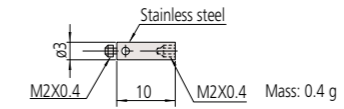

Code No.	06ABN805
Description	MS2-EXT20

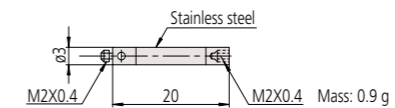

Code No.	908884
Description	MS2-EXT20C

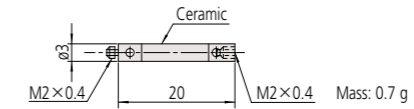

Code No.	06ABN806
Description	MS2-EXT30

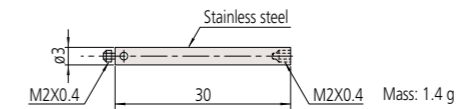

Code No.	06ABN807
Description	MS2-EXT40

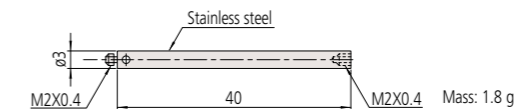

Code No.	908885
Description	MS2-EXT40C

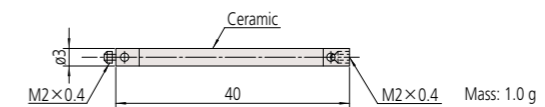

Code No.	06AAL257
Description	MS2-EXT40G

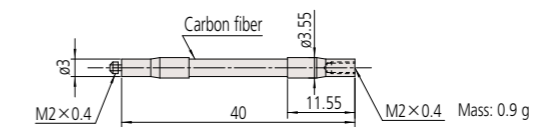

- For TP200
- For mounting stylus, attachment tools for carbon extension is required. (refer to page 62)

Code No.	06AAL258
Description	MS2-EXT50G

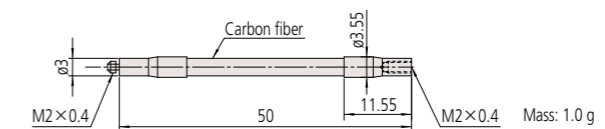

- For TP200
- For mounting stylus, attachment tools for carbon extension is required. (refer to page 62)

Code No.	908886	<p>Mass: 1.3 g</p>
Description	MS2-EXT60C	
Code No.	06ABN809	<p>Mass: 1.3 g</p>
Description	MS2-EXT70G	
Code No.	908887	<p>Mass: 1.6 g</p>
Description	MS2-EXT80C	
Code No.	06ABN810	<p>Mass: 1.5 g</p>
Description	MS2-EXT90G	
Code No.	153142	<p>Mass: 1.6 g</p>
Code No.	06AFA210	<p>Mass: 1.6 g</p>
Code No.	06ABN812	<p>Mass: 0.8 g</p>
Code No.	06ABN813	<p>Mass: 0.4 g</p>

• Not recommended for mounting on TP200, otherwise an input error may result.  
 • Also for other probes it is recommended to use in the vertical direction. Otherwise an input error may result depending on the drive speed or acceleration.  
 • For mounting stylus, attachment tools for carbon extension is required. (refer to page 62)

• Adapter for turning the stylus in the desired direction.

• Adapter for turning the stylus in the desired direction.

• Adapter for turning the stylus in one of the five directions.

• This is an adapter for a probe, whose stylus attachment section is threaded to M2, to accept M3-threaded stylus.

### ■ Stylus (Mounting thread dia.: M3)

Code No.	06ABN816	06AFG369	06AFG430	<p>Mass: 1.0 g</p>	<table border="1"> <thead> <tr> <th>Code No.</th> <th>A (mm)</th> </tr> </thead> <tbody> <tr> <td>06ABN816</td> <td>20</td> </tr> <tr> <td>06AFG369</td> <td>21</td> </tr> <tr> <td>06AFG430</td> <td>21</td> </tr> </tbody> </table> <ul style="list-style-type: none"> <li>• Use with a measuring force 0.4 N or less.</li> <li>• This stylus may have a short life compared with normal styli.</li> <li>• The use of a ceramic master ball (high precision type) Sφ10 mm is recommended.</li> </ul>	Code No.	A (mm)	06ABN816	20	06AFG369	21	06AFG430	21
Code No.	A (mm)												
06ABN816	20												
06AFG369	21												
06AFG430	21												
Description	MS3-0.5R2	MS3-0.5SN2	MS3-0.5Z2										
Material of probe tip	Ruby	Silicon nitride	Zirconia										
Code No.	06ABN817	06AFG370	06AFG431	<p>Mass: 1.0 g</p>									
Description	MS3-1R4	MS3-1SN4	MS3-1Z4										
Material of probe tip	Ruby	Silicon nitride	Zirconia										
Code No.	06ABF414	<p>Mass: 1.0 g</p>											
Description	MS3-1R12												
Code No.	06ABF412	<p>Mass: 0.9 g</p>											
Description	MS3-1R25												
Code No.	06ABN818	06AFG371	06AFG432	<p>Mass: 0.8 g</p>									
Description	MS3-1.5R12.5	MS3-1.5SN12.5	MS3-1.5Z12.5										
Material of probe tip	Ruby	Silicon nitride	Zirconia										
Code No.	06ABN819	06AFG372	06AFG433	<p>Mass: 0.93 g</p>									
Description	MS3-1.5R22.5	MS3-1.5SN22.5	MS3-1.5Z22.5										
Material of probe tip	Ruby	Silicon nitride	Zirconia										
Code No.	06ABN820	06AFG373	06AFG434	<p>Mass: 1.0 g</p>									
Description	MS3-2R9.6	MS3-2SN9.6	MS3-2Z9.6										
Material of probe tip	Ruby	Silicon nitride	Zirconia										
Code No.	06ABN821	06AFG374	06AFG435	<p>Mass: 1.32 g</p>									
Description	MS3-2R22.5	MS3-2SN22.5	MS3-2Z22.5										
Material of probe tip	Ruby	Silicon nitride	Zirconia										
Code No.	06ABN822	06AFG375	06AFG436	<p>Mass: 1.58 g</p>									
Description	MS3-2R32.5	MS3-2SN32.5	MS3-2Z32.5										
Material of probe tip	Ruby	Silicon nitride	Zirconia										

• Use with a measuring force 0.4 N or less.  
 • This stylus may have a short life compared with normal styli.  
 • The use of a ceramic master ball (high precision type) Sφ10 mm is recommended.

Code No.	06ABF416
Description	MS3-2R62.5

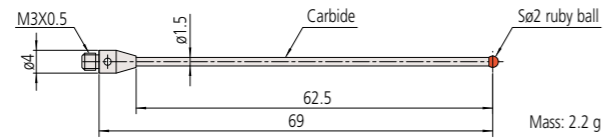

Code No.	06ABN823	06AFG376	06AFG437
Description	MS3-3R12	MS3-3SN12	MS3-3Z12
Material of probe tip	Ruby	Silicon nitride	Zirconia

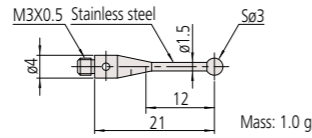

Code No.	06ABN824	06AFG377	06AFG438
Description	MS3-3R23.7	MS3-3SN23.7	MS3-3Z23.7
Material of probe tip	Ruby	Silicon nitride	Zirconia

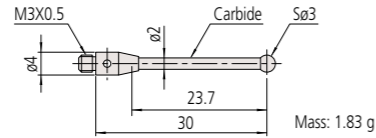

Code No.	06ABN825	06AFG378	06AFG439
Description	MS3-3R33.7	MS3-3SN33.7	MS3-3Z33.7
Material of probe tip	Ruby	Silicon nitride	Zirconia

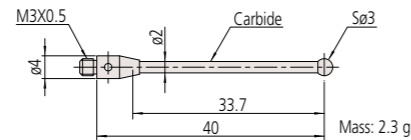

Code No.	06ABN826	06AFG379	06AFG440
Description	MS3-3R43.7	MS3-3SN43.7	MS3-3Z43.7
Material of probe tip	Ruby	Silicon nitride	Zirconia

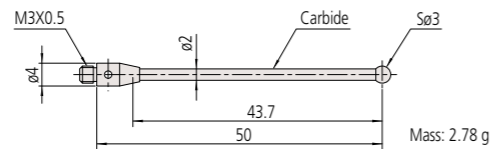

Code No.	06ABF415
Description	MS3-3R50

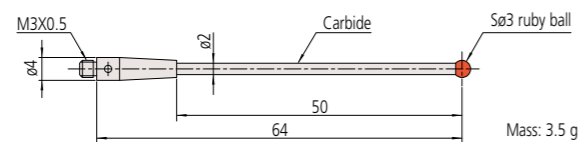

Code No.	06ABN827	06AFG380	06AFG441
Description	MS3-4R17	MS3-4SN17	MS3-4Z17
Material of probe tip	Ruby	Silicon nitride	Zirconia

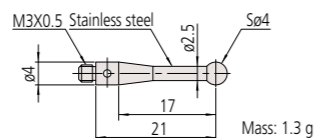

Code No.	06ABN828	06AFG381	06AFG442
Description	MS3-4R27	MS3-4SN27	MS3-4Z27
Material of probe tip	Ruby	Silicon nitride	Zirconia

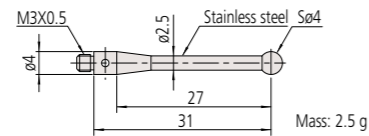

Code No.	06ABN829	06AFG382	06AFG443
Description	MS3-4R36	MS3-4SN36	MS3-4Z36
Material of probe tip	Ruby	Silicon nitride	Zirconia

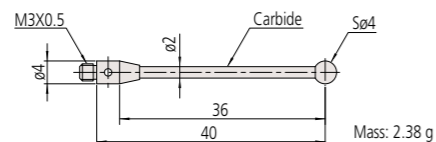

Code No.	06ABN830	06AFG383	06AFG444
Description	MS3-4R46	MS3-4SN46	MS3-4Z46
Material of probe tip	Ruby	Silicon nitride	Zirconia

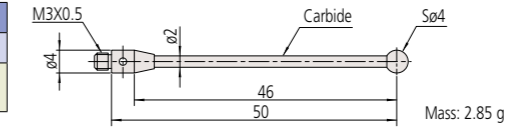

Code No.	06ABF403
Description	MS3-4R53

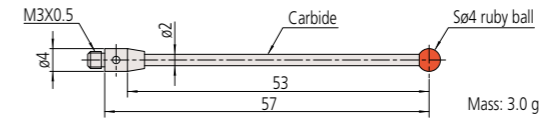

Code No.	06ABN831	06AFG384	06AFG445
Description	MS3-5R21	MS3-5SN21	MS3-5Z21
Material of probe tip	Ruby	Silicon nitride	Zirconia

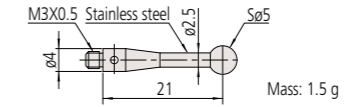

Code No.	163874	06AFG385	06AFG446
Description	MS3-5R31	MS3-5SN31	MS3-5Z31
Material of probe tip	Ruby	Silicon nitride	Zirconia

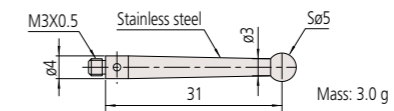

Code No.	06ABN832	06AFG386	06AFG447
Description	MS3-5R50C	MS3-5SN50C	MS3-5Z50C
Material of probe tip	Ruby	Silicon nitride	Zirconia

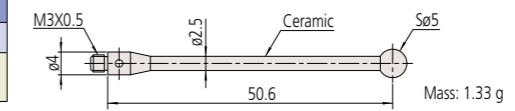

Code No.	06ABS911	06AFG387	06AFG448
Description	MS3-6R75G	MS3-6SN75G	MS3-6Z75G
Material of probe tip	Ruby	Silicon nitride	Zirconia

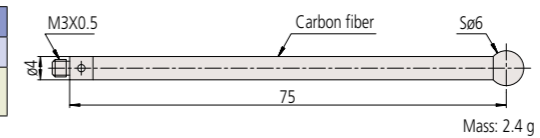

- For SP25M
- SM25-2 or SM25-3 is required for use with SP25M.
- For the applicable length for each P25M module, refer to the specifications for SP25M (page 8).

Code No.	06ABS912	06AFG388	06AFG449
Description	MS3-6R100G	MS3-6SN100G	MS3-6Z100G
Material of probe tip	Ruby	Silicon nitride	Zirconia

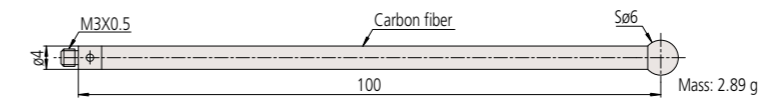

- For SP25M
- SM25-3 is required for use with SP25M.
- For the applicable length for each P25M module, refer to the specifications for SP25M (page 8).

Code No.	06ABS913	06AFG389	06AFG450
Description	MS3-8R75G	MS3-8SN75G	MS3-8Z75G
Material of probe tip	Ruby	Silicon nitride	Zirconia

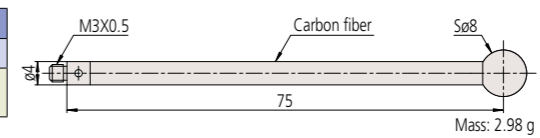

- For SP25M
- SM25-2 or SM25-3 is required for use with SP25M.
- For the applicable length for each P25M module, refer to the specifications for SP25M (page 8).

Code No.	06ABS914	06AFG390	06AFG451
Description	MS3-8R100G	MS3-8SN100G	MS3-8Z100G
Material of probe tip	Ruby	Silicon nitride	Zirconia

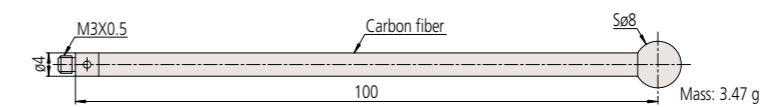

- For SP25M
- SM25-3 is required for use with SP25M.
- For the applicable length for each P25M module, refer to the specifications for SP25M (page 8).

Code No.	06ABF407	Description	MS3-8R130C
----------	----------	-------------	------------

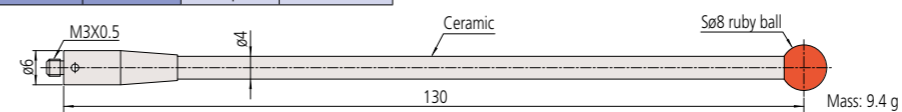

- Cannot be mounted on the old scanning probe models including MPP-2, MPP-2H, and MPP-5.
- Strongly recommended to use in the vertical position for touch-trigger probes. Otherwise an input error may result depending on the drive speed or acceleration.

Code No.	916492
Description	MS3-30C

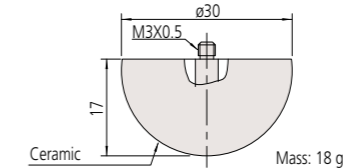

- Cannot be mounted on SP25M.



Code No.	169011		<ul style="list-style-type: none"> <li>The use may be restricted depending on the application. Please contact your local Mitutoyo sales office.</li> </ul>
Description	MS3-DISC12.7-2		
Code No.	06ABN833		
Description	MS3-EXT10		
Code No.	06ABN834		
Description	MS3-EXT20		
Code No.	06ABN835		
Description	MS3-EXT35		
Code No.	06ABN836		
Description	MS3-EXT50C		
Code No.	06ABS915		<ul style="list-style-type: none"> <li>For SP25M</li> <li>SM25-3 is required for use with SP25M.</li> <li>For the applicable length for each P25M module, refer to the specifications for SP25M (page 8).</li> </ul>
Description	MS3-EXT75G		
Code No.	06ABS916		<ul style="list-style-type: none"> <li>For SP25M</li> <li>SM25-3 is required for use with SP25M.</li> <li>For the applicable length for each P25M module, refer to the specifications for SP25M (page 8).</li> </ul>
Description	MS3-EXT100G		
Code No.	06ABN838		<ul style="list-style-type: none"> <li>Adapter for turning the stylus in the desired direction.</li> </ul>
Description	MS3-stylus knuckle		
Code No.	06ABN839		<ul style="list-style-type: none"> <li>Adapter for turning the stylus in one of the five directions.</li> </ul>
Description	MS3-stylus center		
Code No.	06ABN837		<ul style="list-style-type: none"> <li>This is an adapter for a probe, whose stylus attachment section is threaded to M3, to accept M2-threaded stylus.</li> </ul>
Description	MS3-M2 female-adapter		
Code No.	167234		<ul style="list-style-type: none"> <li>This is an adapter for a probe, whose stylus attachment section is threaded to M3, to accept straight-shank type stylus.</li> </ul>
Description	MS3-φ4.5-adapter		

## Stylus (Mounting thread M4)

Code No.	06ABN840		
Description	MS4-1R4.5		
Code No.	06ABN841		
Description	MS4-2R8		
Code No.	06ABN842		
Description	MS4-4R13.5		
Code No.	06ABQ149		
Description	MS4-4R33C		
Code No.	06ABN843		
Description	MS4-8R50C		
Code No.	06ABN844		
Description	MS4-8R100C		
Code No.	06ABN845		
Description	MS4-6R88G		
Code No.	06ABN846		
Description	MS4-6R138G		
Code No.	06ABN847		<ul style="list-style-type: none"> <li>Cannot be mounted on SP25M.</li> </ul>
Description	MS4-6R188G		
Code No.	06ABN848		
Description	MS4-EXT30C		
Code No.	06ABN849		
Description	MS4-EXT50C		



Code No.	06ABN850		
Description	MS4-EXT100C		
Code No.	06AAD457		
Description	MS4-EXT200C		
Code No.	06ABN851		
Description	MS4-M3EXT20		
Code No.	06ABN852		
Description	MS4-M3EXT50C		
Code No.	06ABN853		
Description	MS4-M3EXT75C		
Code No.	06ABN854		
Description	MS4-M3EXT100C		
Code No.	06AAD460		<ul style="list-style-type: none"> <li>• Adapter for turning the stylus in the desired direction.</li> </ul>
Code No.	06ABN857		<ul style="list-style-type: none"> <li>• Adapter for mounting the stylus in the five positions.</li> </ul>
Code No.	06ABN855		<ul style="list-style-type: none"> <li>• This is an adapter for a probe, whose stylus attachment section is threaded to M4, accept M3-threaded stylus.</li> </ul>
Code No.	06ABN856		<ul style="list-style-type: none"> <li>• This is an adapter for a probe, whose stylus attachment section is threaded to M4, accept M2-threaded stylus.</li> </ul>

### ■ Stylus (Mounting thread M5)

Code No.	06ABS917		
Description	MS5-0.5R4		
Code No.	06ABS918		
Description	MS5-0.7R5		
Code No.	06ABS920		
Description	MS5-1R5		
Code No.	06ABS921		
Description	MS5-1.5R11		
Code No.	06ABS923		
Description	MS5-2R11		
Code No.	06ABS924		
Description	MS5-2R21		
Code No.	06ABS925		
Description	MS5-2R31		
Code No.	06ABS926		
Description	MS5-2.5R31		
Code No.	06ABS927		
Description	MS5-2.5R41		
Code No.	06ABS928		
Description	MS5-3R11		
Code No.	06ABS929		
Description	MS5-3R21		
Code No.	06ABS930		
Description	MS5-3R31		
Code No.	06ABS931		
Description	MS5-3R41		

Code No.	06ABS932		Mass: 16.30 g
Description	MS5-3R55		
Code No.	06ABS933		Mass: 5.19 g
Description	MS5-4R11		
Code No.	06ABS934		Mass: 5.64 g
Description	MS5-4R21		
Code No.	06ABS935		Mass: 6.55 g
Description	MS5-4R41		
Code No.	06ABS936		Mass: 23.07 g
Description	MS5-4R50		
Code No.	06ABS937		Mass: 11.61 g
Description	MS5-4R65		
Code No.	06ABS938		Mass: 6.06 g
Description	MS5-5R11		
Code No.	06ABS939		Mass: 7.10 g
Description	MS5-5R21		
Code No.	06ABS940		Mass: 9.19 g
Description	MS5-5R41		
Code No.	06ABS941		Mass: 23.31 g
Description	MS5-5R50		
Code No.	06ABS942		Mass: 11.80 g
Description	MS5-5R65		
Code No.	06ABS943		Mass: 14.40 g
Description	MS5-5R91		
Code No.	06ABS944		Mass: 6.10 g
Description	MS5-6R39G		

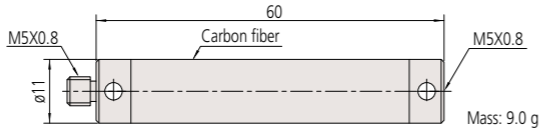
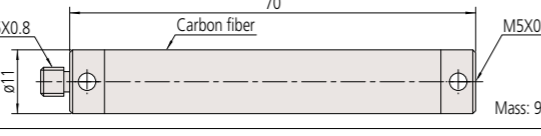
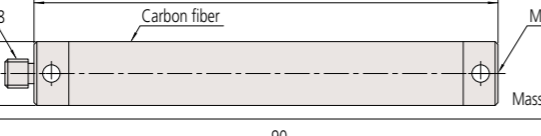
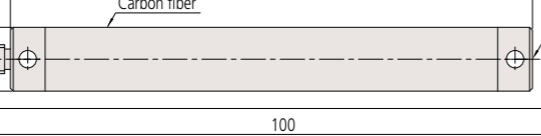
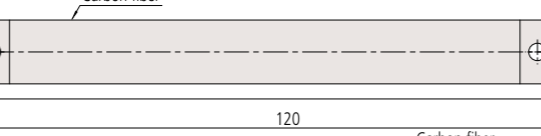
Code No.	06ABS945		Mass: 6.59 g
Description	MS5-6R64G		
Code No.	06ABS946		Mass: 7.08 g
Description	MS5-6R89G		
Code No.	06ABS947		Mass: 7.96 g
Description	MS5-8R37G		
Code No.	06ABU673		Mass: 30 g
Description	MS5-8R38C		
Code No.	06ABS948		Mass: 9.06 g
Description	MS5-8R62G		
Code No.	06ABS949		Mass: 10.17 g
Description	MS5-8R87G		
Code No.	06ABS950		Mass: 8.91 g
Description	MS5-10R37G		
Code No.	06ABS951		Mass: 10.01 g
Description	MS5-10R62G		
Code No.	06ABS952		Mass: 11.11 g
Description	MS5-10R87G		
Code No.	06ABS953		Mass: 7.0 g
Description	MS5-16C		
Code No.	06ABS954		Mass: 10.0 g
Description	MS5-22C		
Code No.	06ABS955		Mass: 7.6 g
Description	MS5-EXT40G		
Code No.	06ABS956		Mass: 8.3 g
Description	MS5-EXT50G		

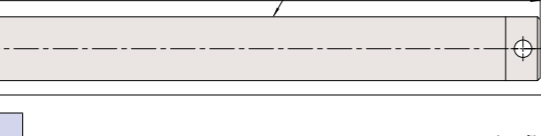
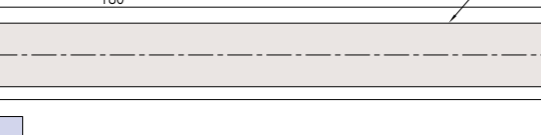
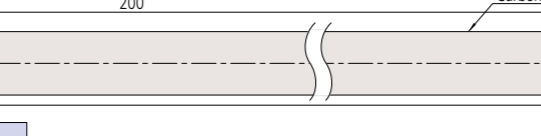
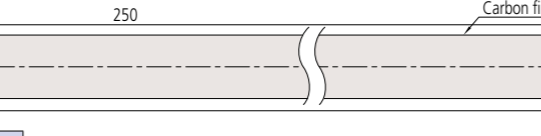
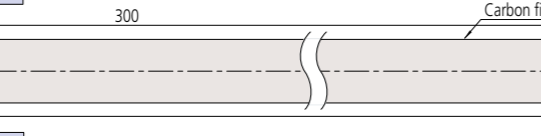
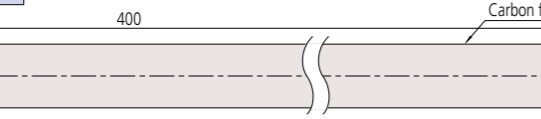
Code No.	06ABS957	Description	MS5-EXT60G		Mass: 9.0 g
Code No.	06ABS958	Description	MS5-EXT70G		Mass: 9.7 g
Code No.	06ABS959	Description	MS5-EXT80G		Mass: 10.4 g
Code No.	06ABS960	Description	MS5-EXT90G		Mass: 11.1 g
Code No.	06ABS961	Description	MS5-EXT100G		Mass: 11.8 g
Code No.	06ABS962	Description	MS5-EXT120G		Mass: 13.2 g
Code No.	06ABS963	Description	MS5-EXT150G		Mass: 15.4 g
Code No.	06ABS964	Description	MS5-EXT180G		Mass: 17.5 g
Code No.	06ABS965	Description	MS5-EXT200G		Mass: 18.9 g
Code No.	06ABS966	Description	MS5-EXT250G		Mass: 22.4 g
Code No.	06ABS967	Description	MS5-EXT300G		Mass: 25.9 g
Code No.	06ABS968	Description	MS5-EXT400G		Mass: 33.0 g

### Attachment Tools

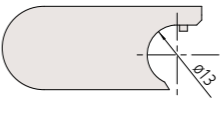
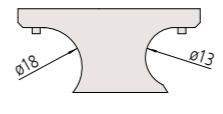
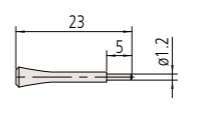
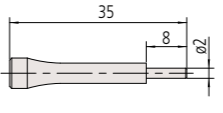
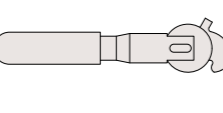
Code No.	161534	Description	Single-ended wrench		Mass: 5.0 g	• Attachment tool for probes with the body diameter of 13 mm and probe extensions.
Code No.	161535	Description	Double-ended wrench		Mass: 5.0 g	• Attachment tool for probes with the body diameter of 13 mm or 18 mm and probe extensions.
Code No.	153140	Description	M2-stylus tool		Mass: 0.7 g	• Stylus attachment/detachment tool for M2 and M3 mounting screws.
Code No.	181279	Description	MS4-stylus tool		Mass: 3.5 g	• Stylus attachment/detachment tool for M4 mounting screws.
Code No.	06AAL264	Description	Attachment tool for carbon-fiber extensions		Mass: 20.0 g	• Attachment/detachment tool for carbon-fiber extensions whose mounting thread is M2.

### Stylus Set [Code No. 06ABT114]

Ref. No.	Description	Specifications	Qty	Remarks
1	MS4-1R4.5-S	11x20 mm (M4)	2	High-accuracy specifications
2	MS4-2R8-S	22x20 mm (M4)	2	High-accuracy specifications
3	MS4-4R13.5-S	44x20 mm (M4)	2	High-accuracy specifications
4	MS4-4R33-S	44x50 mm (M4)	1	High-accuracy specifications
5	MS4-8R50C-S	50x80 mm (M4)	1	High-accuracy specifications
6	MS4-8R100C-S	100x80 mm (M4)	1	High-accuracy specifications
7	MS3-30C	30 Ceramic ball (M3)	1	
8	MS4-EXT50C	L50 Extension (M4-M4)	2	
9	MS4-EXT30C	L30 Extension (M4-M4)	1	
10	MS4-M3EXT20	L20 Extension (M4-M4)	1	
11	MS4-M3EXT75C	L75 Extension (M4-M3)	1	
12	MS4-stylus center	M4 Stylus center	1	
13	MS3-stylus center	M3 Stylus center	1	
14	MS2-stylus center	M2 Stylus center	1	
15	MS4-stylus tool	M4 Stylus tool	2	
16	MS2-stylus tool	M2, M3 Stylus tool	2	
17	MS4-M3 female-adapter	M4-M3 adapter (L9)	2	
18	MS3-M2 female-adapter	M3-M2 adapter (L5)	5	
19	Storage box		1	

Note: Some items cannot be ordered separately.  
 • For other necessary styli, please select from the styli list at the end of this document.  
 • For probe extensions, refer to PH10M/PH10MQ (pages 30-31).



■ Stylus Set

■ Set No. 06AGG825\*



Description	ø (mm)	L (mm)	Qty
Stylus CF-ruby M2	4	50	5
Stylus tungsten M3	3	40	1
Stylus tungsten M2	2	30	2
Stylus tungsten M2	1	27.5	1
Long adapt M3/M2 CF	—	30	1
Knuckle Joint steel M2	—	17.2	1
5-way stylus holder M2	—	8	1
Pin spanner	1.2	23	2
Hexagon wrench	—	—	1

\* Only available as a set.

■ Set No. 06AGG826\*



Description	ø (mm)	L (mm)	Qty
Stylus steel-ruby M2	4	20	1
Stylus steel-ruby M2	3	20	1
Stylus steel-ruby M2	2	20	5
Stylus steel-ruby M2	1	10	1
Extension steel M2	—	30	1
Extension steel M2	—	20	1
Extension steel M2	—	10	4
5-way stylus holder M2	—	8	1
Pin spanner	1.2	23	2

\* Only available as a set.

■ Set No. 06AGG827\*



Description	ø (mm)	L (mm)	Qty
Stylus tungsten M2	0.5	10	1
Stylus tungsten M2	0.7	10	1
Stylus steel-ruby M2	1	10	1
Stylus steel-ruby M2	1	20	1
Stylus steel-ruby M2	2	20	4
Adaptor M3/M2	—	5	1
5-way stylus holder M2	—	8	1
Extension steel M2	—	20	1
Pin spanner	1.2	23	2

\* Only available as a set.

■ Stylus Cleaner

■ Preventing inaccurate measurements caused by an unclean stylus

The stylus cleaner removes dust and debris adhering to the stylus of a CNC coordinate measuring machine. It removes dirt from the stylus in only about 30 seconds, due to the combination of cleaning fluid and compressed air.

**Stylus cleaner:**

- Eliminates the hassle of manual stylus cleaning.
- Avoids the risk of inaccurate measurements caused by an unclean stylus.
- Allows accurate calibration by conducting stylus cleaning before calibration.

**A stylus cleaner improves the efficiency and reliability of your quality assurance!**



Unclean stylus



The probe moves to the sensor of the stylus cleaner.



The probe moves to above the cleaner.



Stylus after cleaning



Cleaning complete



The probe moves the cleaning unit up and down several times to clean the stylus with cleaning fluid and compressed air.

20 seconds  
Time  
(number of  
times) can be  
set arbitrarily.

Applicable with down-facing styli  
Applicable stylus length: 20 mm or more  
Applicable stylus diameter: 8 mm or less

By registering the cleaner position in advance, these operations can be performed as CNC part programs.  
Automatic cleaning operation can be added after probe replacement or during workpiece measurement.  
(The CNC part program for stylus cleaning is provided by Mitutoyo.)

■ Ceramic Master Ball

**Ceramic master ball (standard type)**

- Ball sphericity: 0.13 μm or less
- Ball diameter dimensional tolerance:  $S\phi 20_{-0.1}^0$  mm

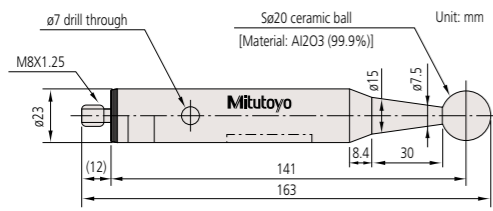

**Ceramic master ball (high-accuracy type)**

- Ball sphericity: 0.08 μm or less
- Ball diameter dimensional tolerance:  $S\phi 20_{-0.1}^0$  mm

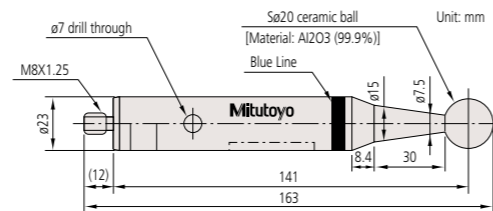

**Ceramic master ball (high-accuracy type)**

- Ball sphericity: 0.08 μm or less
- Ball diameter dimensional tolerance:  $S\phi 10_{-0.05}^0$  mm

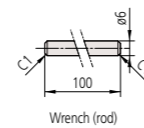
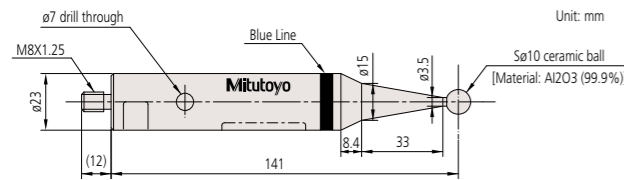

**Base**

Base for a ceramic master ball

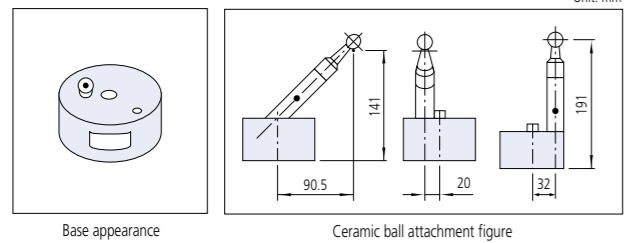

**Master ball cover (Part No. 06AFJ091)**

Cover for a ceramic master ball

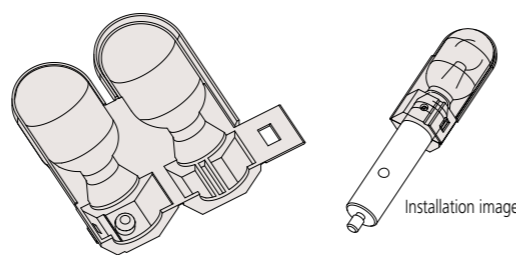

**Set break-downs**

Set code No.	Ball diameter (mm)	Type	Master ball cover	Base	Inspection certificate	Calibration certificate	Traceability system diagram	Calibration certificate (JCSS)
06AFK288A	20	Standard	✓	-	✓	-	-	-
06AFK288B	20	Standard	✓	-	✓	✓	✓	-
06AFK288D	20	Standard	✓	-	✓	-	-	✓
06AFK289A	20	Standard	✓	✓	✓	-	-	-
06AFK289B	20	Standard	✓	✓	✓	✓	✓	-
06AFK289D	20	Standard	✓	✓	✓	-	-	✓
06AFK290A	20	High-accuracy	✓	-	✓	-	-	-
06AFK290B	20	High-accuracy	✓	-	✓	✓	✓	-
06AFK290D	20	High-accuracy	✓	-	✓	-	-	✓
06AFK291A	20	High-accuracy	✓	✓	✓	-	-	-
06AFK291B	20	High-accuracy	✓	✓	✓	✓	✓	-
06AFK291D	20	High-accuracy	✓	✓	✓	-	-	✓
06AFK292A	10	High-accuracy	✓	-	✓	-	-	-
06AFK292B	10	High-accuracy	✓	-	✓	✓	✓	-
06AFK292D	10	High-accuracy	✓	-	✓	-	-	✓

**Optional accessory for the Ceramic Master Ball**

**Spacer**

Spacer for the base

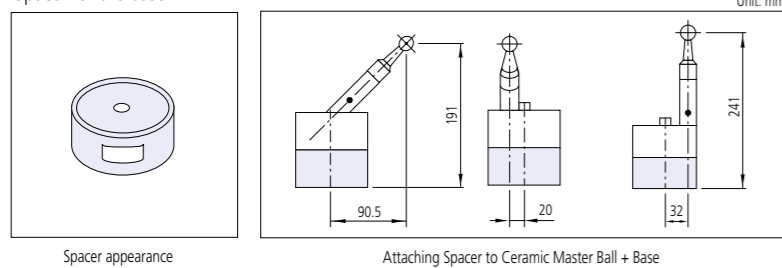

■ Joystick Box

The joystick box allows users to easily operate their CMM from a remote location when creating a part program in teaching mode or operating the machine manually. Three types are available to suit your purpose.



■ Safety Laser Scanner



The safety of CNC CMM can be enhanced by attaching the device to the machine. When a person enters the set hazardous area, the machine will reduce speed and stop automatically.

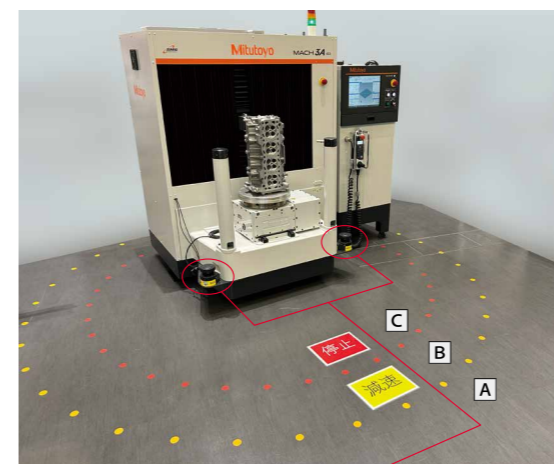

Installation of safety laser scanners  
Two safety laser scanners are attached to both sides of front of MACH-3A.

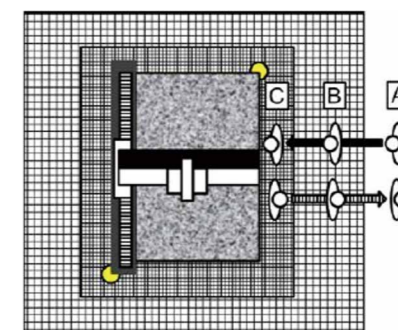

Operation of safety laser scanners

	Hazardous area	Speed
C	forbidden area	stop
B	warned area	low speed
A	outside the hazardous area	fast movement speed



**Whatever your challenges are, Mitutoyo supports you from start to finish.**

Mitutoyo is not only a manufacturer of top quality measuring products but one that also offers qualified support for the lifetime of the equipment, backed up by comprehensive services that ensure your staff can make the very best use of the investment.

Apart from the basics of calibration and repair, Mitutoyo offers product and metrology training, as well as IT support for the sophisticated software used in modern measuring technology. We can also design, build, test and deliver measuring solutions and even, if deemed cost-effective, take your critical measurement challenges in-house on a sub-contract basis.



**Find additional product literature and our product catalogue**

<https://www.mitutoyo.co.jp/global.html>

**Our products are classified as regulated items under Japanese Foreign Exchange and Foreign Trade Law. Please consult us in advance if you wish to export our products to any other country. If the purchased product is exported, even though it is not a regulated item (Catch-All controls item), the customer service available for that product may be affected. If you have any questions, please consult your local Mitutoyo sales office.**

Note: Product illustrations are without obligation. Product descriptions, in particular any and all technical specifications, are only binding when explicitly agreed upon.  
MITUTOYO and MICAT are either registered trademarks or trademarks of Mitutoyo Corp. in Japan and/or other countries/regions. Other product, company and brand names mentioned herein are for identification purposes only and may be the trademarks of their respective holders.  
All product information contained in this brochure is current as of August 2023.

# Mitutoyo

## Mitutoyo Corporation

20-1, Sakado 1-Chome,  
Takatsu-ku, Kawasaki-shi,  
Kanagawa 213-8533, Japan  
T +81 (0) 44 813-8230  
F +81 (0) 44 813-8231  
<https://www.mitutoyo.co.jp>