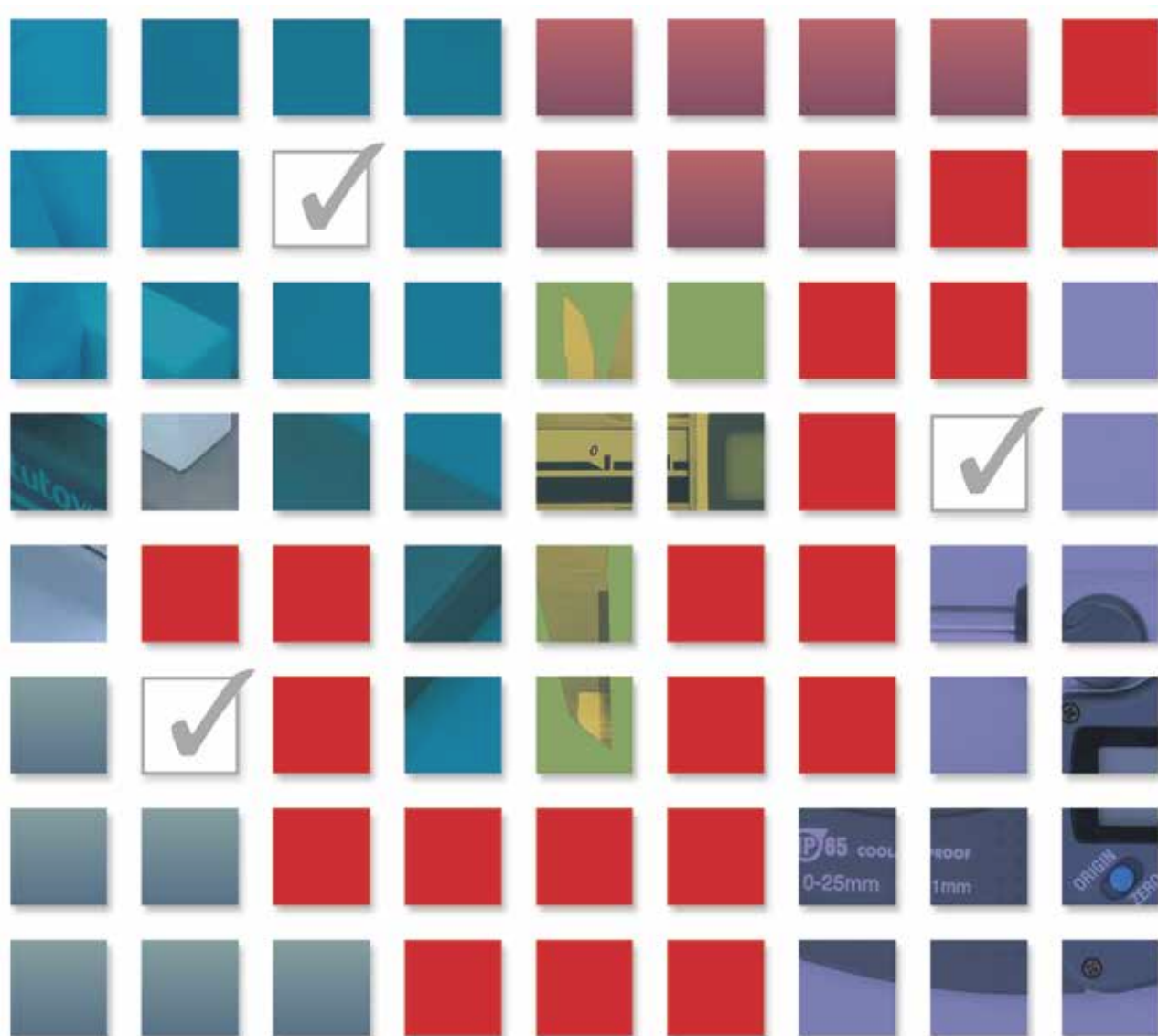


Check Points for Small Tool Instruments



Introduction

Measurement... the word can mean many things.

In the case of length measurement there are many kinds of measuring instrument and corresponding measuring methods.

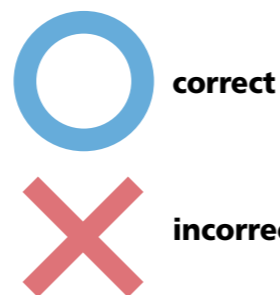
For efficient and accurate measurement, the proper usage of measuring tools and instruments is vital.

Additionally, to ensure the long working life of those instruments, care in use and regular maintenance is important.



We have put together this booklet to help anyone get the best use from a Mitutoyo measuring instrument for many years, and sincerely hope it will help you.

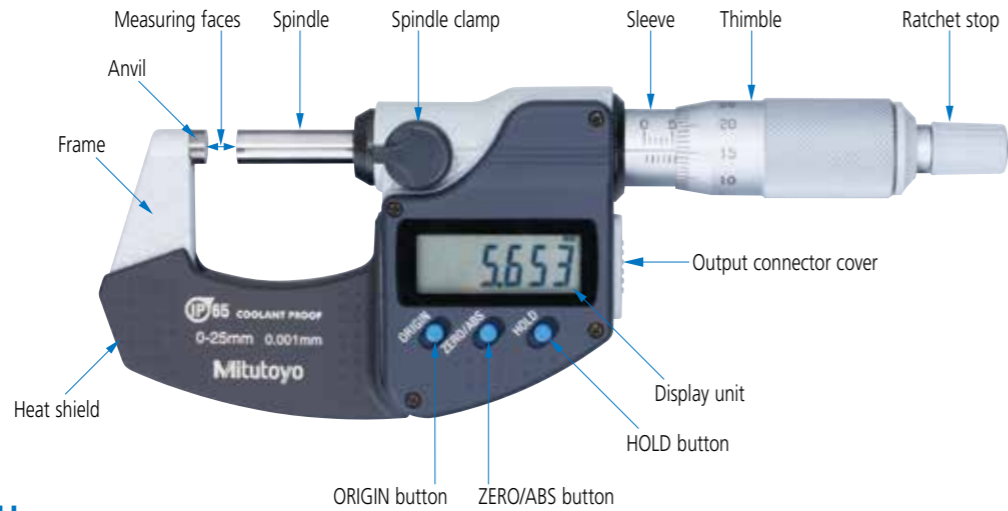
CONVENTIONS USED IN THIS BOOKLET

The following symbols are used in this booklet to help the user obtain reliable measurement data through correct instrument operation.



CONTENTS

Micrometers		
Digimatic Outside Micrometers (Coolant Proof Micrometers)		1
Outside Micrometers		2
Disk Micrometers		3
Screw Thread Micrometers (Interchangeable type)		4
Holtest		
Digimatic Holtest (Three-point Bore Micrometers)		5
Holtest (Two-point/Three-point Bore Micrometers)		6
Bore Gages		7
Bore Gages (Small Holes)		8
ABSOLUTE Digimatic Bore Gage CG-D		9
Calipers		
ABSOLUTE Digimatic Calipers		10
Dial Calipers		11
Vernier Calipers		12
Long ABSOLUTE Digimatic Calipers		13
ABSOLUTE Inside Calipers		14
Offset Centerline Calipers		15
Height Gages		
Digimatic Height Gages		16
Dial Height Gages		17
Depth Gages		
Depth Micrometers (Interchangeable Rod Type)		18
ABSOLUTE Digimatic and Vernier Depth Gages		19
ABSOLUTE Digimatic and Dial Depth Gages		20
Indicators		
Digimatic Indicators		21
Dial Indicators		22
Dial Test Indicators (Lever-operated Dial Indicators)		23
Thickness Gages		24
Stand		
Transfer and Comparator Stands		25
Gauge Blocks		
Rectangular Gauge Blocks		26
Products Used for Maintenance of Measuring Instruments		27
Mitutoyo Network		
Download service at Mitutoyo website		28



Before Use

1. Check to see whether the thimble moves smoothly without any jamming or unevenness by rotating it all the way through its range.
2. Replace button cell with an SR44 type if necessary (Order No.938882).
3. Clamp a sheet of lint-free paper between the anvil and spindle, as if measuring its thickness, and slowly draw it away to remove dust or dirt adhering to the measuring faces.
4. Slowly bring the measuring faces into contact and:
 - Rotate the ratchet 3 to 5 stops to apply a constant force to check the zero-point*.
 - If constant pressure is applied roughly, the anvil side is pressed excessively, which may have effect on measurement accuracy. (Photo 1)
 - * For 0-25mm range micrometers, datum-point will be 0.
5. When tightening the output connector cover and battery cap, be careful not to let the rubber seal get trapped by the cap or cover. (Fig. 1)



Photo 1

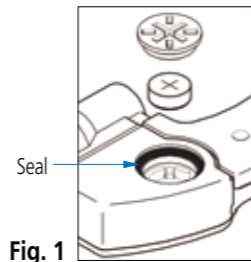


Fig. 1

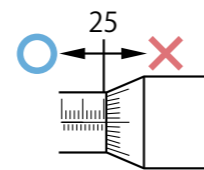


Fig. 2

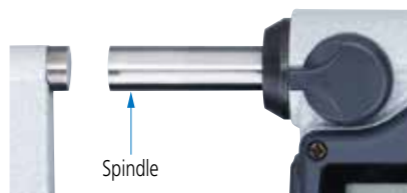


Photo 2

4. If using the instrument for an extended period of time, regularly check (and if necessary adjust) the zero point to allow for thermal expansion.

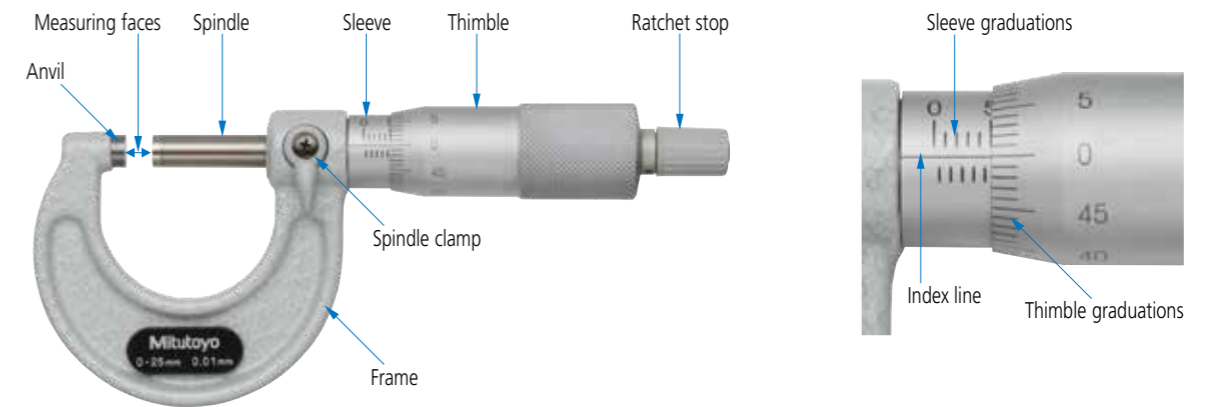
If the instrument is damaged due to being dropped or struck hard, or for any other reason, do not use it and contact us for repair.

After Use

1. Check for damage to the instrument and clean it.
 - If the instrument was used at a place where soluble cutting oil contamination was likely, be sure to perform rust prevention treatment after cleaning.
2. Release the spindle clamp, separate the measuring faces by approximately 0.2 to 2 mm, and then store the instrument. (Photo 3)
3. Store the instrument in a room free of excessive heat and moisture, also dust and oil mist.
4. When storing the instrument for a long time, apply a rust preventing light oil to the spindle as a rust prevention treatment and remove the battery.



Photo 3



Before Use

1. Check to see whether the thimble moves smoothly without any jamming or unevenness by rotating it all the way through its range.
2. Clamp a sheet of lint-free paper between the anvil and spindle, as if measuring its thickness, and slowly draw it away to remove dust or dirt adhering to the measuring faces.
3. Slowly bring the measuring faces into contact and:
 - Rotate the ratchet 3 to 5 stops to apply a constant force to check the zero-point*.
 - If the ratchet stop is rotated at speed an excessive force could be introduced between the measuring faces which may have effect on measurement accuracy. (Photo 1)
 - * For 0-25mm range micrometers, datum-point will be 0.
 - If the zero point is off, reset by rotating the sleeve with the wrench, tapping the wrench gently with a hammer if necessary. (Fig. 1)
4. When resetting the zero point of a large micrometer, perform the adjustment in the actual measurement orientation to minimize measurement uncertainty due to frame deflection.

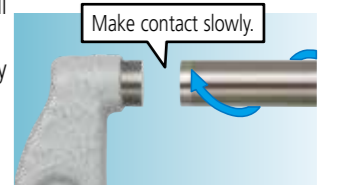


Photo 1

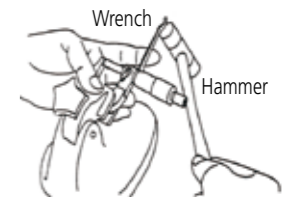


Fig. 1

During Use

1. Read the graduations seen directly from above to avoid parallax error. (Fig. 2)
2. The width of the graduation lines represent approximately 2μm to aid in reading to the nearest 1μm. (Fig. 3)
3. Make sure that the spindle is always protected from impact. (Photo 2)

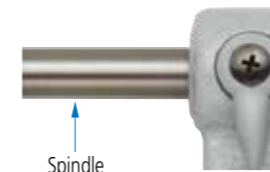


Photo 2

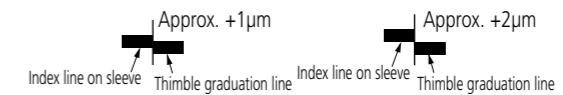


Fig. 3

4. If using the instrument for an extended period of time, regularly check (and if necessary adjust) the zero point to allow for thermal expansion.

If the instrument is damaged due to being dropped or struck hard, or for any other reason, do not use it and contact us for repair.

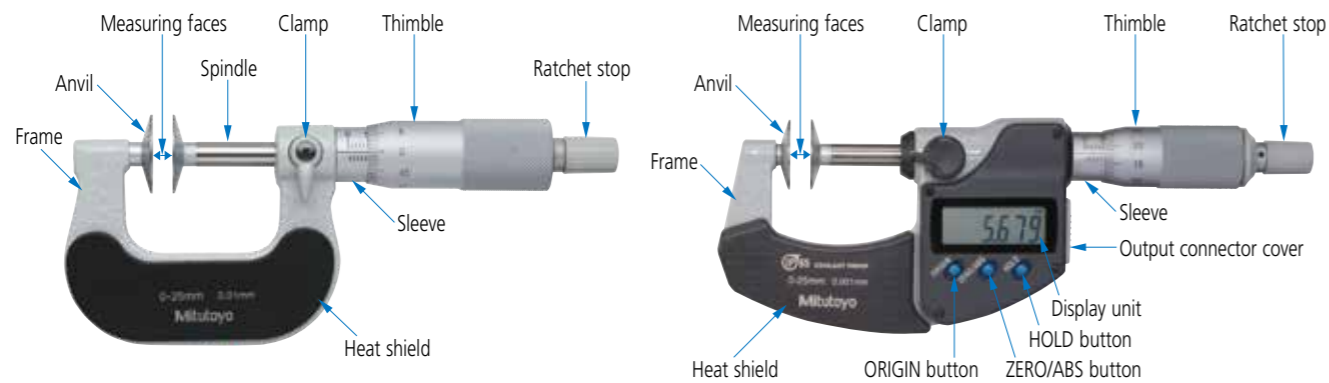
After Use

1. Check for damage to the instrument and clean it.
 - If the instrument was used at a place where soluble cutting oil contamination was likely, be sure to perform rust prevention treatment after cleaning.
2. Release the spindle clamp, separate the measuring faces by approximately 0.2 to 2 mm, and then store the instrument. (Photo 3)
3. Store the instrument in a room free of excessive heat and moisture, also dust and oil mist.
4. When storing the instrument for a long time, apply a rust preventing light oil to the spindle as a rust prevention treatment.



Photo 3

Disk Micrometers



Before Use

1. Check to see whether the thimble moves smoothly without any jamming or unevenness by rotating it all the way through its range.
2. Replace button cell with an SR44 type if necessary (**Order No. 938882**).
3. Clamp a sheet of lint-free paper between the anvil and spindle, as if measuring its thickness, and slowly draw it away to remove dust or dirt adhering to the measuring faces.
4. Slowly bring the measuring faces into contact and:
 - Rotate the ratchet 3 to 5 stops to apply a constant force to check the zero-point*.
 - Operate the ratchet stop smoothly to avoid excessive measuring force being applied, which otherwise may adversely affect measurement accuracy.
 - * For 0-25mm range micrometers, the datum-point will be 0.
 - If the zero point is off, rotate the sleeve to align the index line with the zero graduation on the sleeve.
 - Alternatively, to maximize the accuracy of a measurement the micrometer can be set to gauge blocks equal to the expected measurement value (at the reference point). This minimizes the influence of non-parallelism of the disks and takes advantage of the higher narrow-range accuracy specification. (**Fig.1**)
5. Parallelism can be checked by measuring a gauge block at four positions on the measuring faces and 2mm in from the edge as shown. (**Fig.2**)
6. When resetting the zero (or reference) point of a large micrometer, perform the adjustment in the actual measurement orientation to minimize measurement error due to frame flexure.
7. When tightening the output connector cover and battery cap on a digimatic type, be careful not to let the rubber seal get trapped by the cap or cover.

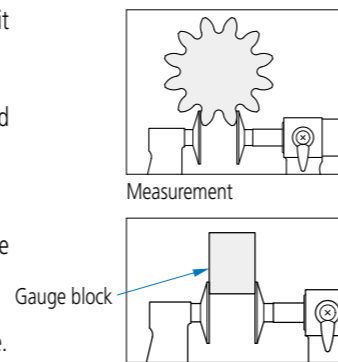


Fig.1 Setting to a reference point

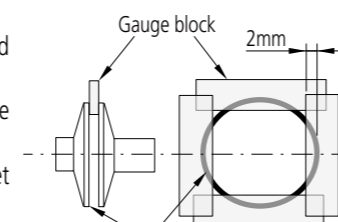


Fig.2 Measuring face

During Use

1. Only perform measurement within the measuring range of the micrometer. Digimatic micrometers can be damaged by retracting the spindle past the end of the range.
2. If any error occurs or the count is displayed abnormally in a digimatic type, remove the battery and reinstall it.
3. Make sure that the anvil and the spindle are always protected from impact.
4. If using the instrument for an extended period of time, regularly check (and if necessary adjust) the zero point (or reference point) to allow for the effects of thermal expansion due to heat conduction from the user's hand.

If the instrument is damaged due to being dropped or struck hard, or for any other reason, do not use it and contact us for repair.

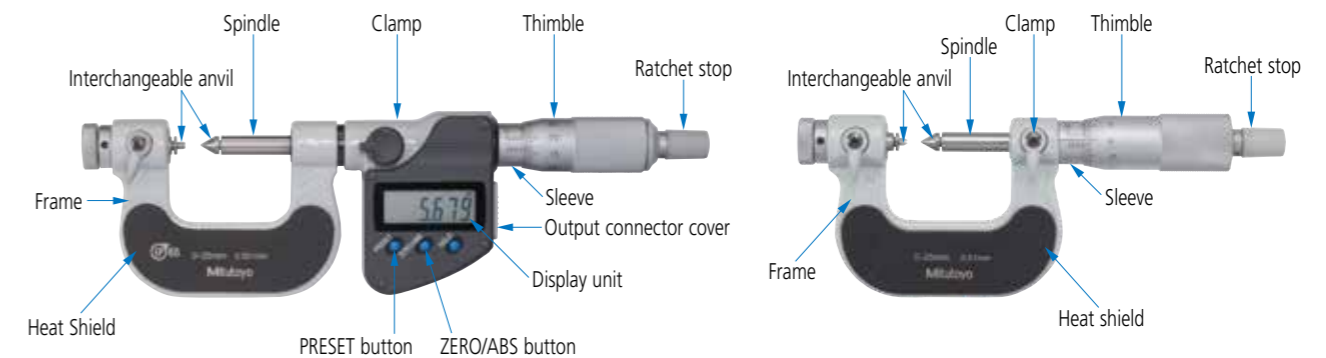
After Use

1. Check for damage to the instrument and clean it.
If the instrument was used at a place where soluble cutting oil contamination was likely, be sure to perform rust prevention treatment after cleaning.
2. Unlock the clamp (**Photo 1**) and store the instrument in a room free of excessive heat and moisture.
3. When storing the instrument for a long time, apply a rust preventing light oil to the spindle as a rust prevention treatment.



Photo 1

Screw Thread Micrometers (Interchangeable contact point type)



Before Use

1. Check to see whether the thimble moves smoothly without any jamming or unevenness by rotating it all the way through its range.
2. Replace button cell with an SR44 type if necessary (**Order No.938882**).
3. Remove dust or dirt adhering to the measuring faces.
4. Do not combine different type of contact points as otherwise a significant measurement error may result.
Always use the same type of interchangeable contact points as a pair. (**Table 1**)
5. Perform zero-point adjustment in the following way:
 - Rotate the thimble to align the index line with the thimble's zero graduation.
 - Rotate the box nut to slowly slide the adjustment bushing, and retain it with the clamp at the female side after bringing the male and female contact points into light contact. (**Photo 1**)
 - Operate the ratchet stop smoothly to avoid excessive measuring force being applied, which may otherwise adversely affect measurement accuracy.
 - Rotate the ratchet 3 to 5 stops to apply a constant force to check the zero-point*.
 - * For 0-25mm range micrometers, datum-point will be 0.
 - If the zero point is off, rotate the sleeve to align the index line with the zero graduation on the sleeve. (For a digimatic type, press the PRESET button to perform the zero-point setting.)
 - For a micrometer with a range greater than 25mm (or 1"), always use the dedicated setting standard supplied to set the reference point.
6. When tightening the output connector cover and battery cap for a digimatic type, be careful not to let the rubber seal get trapped by the cap or cover.

Table 1 Interchangeable contact points

For metric (unify) specification (pair)

Order No.	Code	Pitch range	Female side	Male side
(1)	126-801 M1 (U1)	0.4~0.5 (64~48 TPI)		
(2)	126-802 M2 (U2)	0.6~0.9 (44~28 TPI)		
(3)	126-803 M3 (U3)	1~1.75 (24~14 TPI)		
(4)	126-804 M4 (U4)	2~3 (13~9 TPI)		
(5)	126-805 M5 (U5)	3.5~5 (8~5 TPI)		
(6)	126-806 M6 (U6)	5.5~7 (4.5~3.5 TPI)		

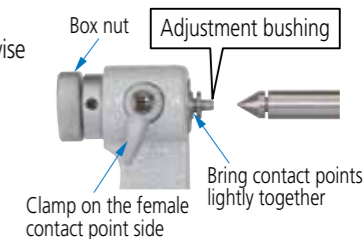


Photo 1

During Use

1. Only perform measurement within the measuring range of the micrometer. Digimatic micrometers can be damaged by retracting the spindle past the end of the range.
2. If any error occurs or the count is displayed abnormally on a digimatic type, remove the battery and reinstall it.
3. Make sure that the spindle and contact points are always protected from impact.
4. If using the instrument for an extended period of time, regularly check (and if necessary adjust) the zero point (or reference point) to allow for the effects of thermal expansion due to heat conduction from the user's hand.

If the instrument is damaged due to being dropped or struck hard, or for any other reason, do not use it and contact us for repair.

After Use

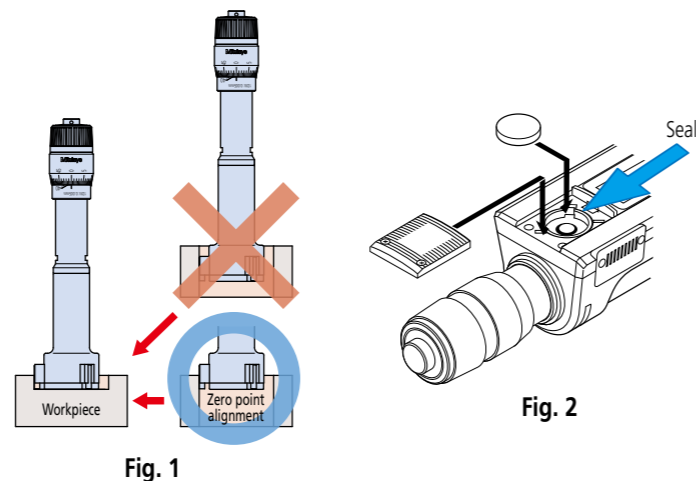
1. Check for damage to the instrument and clean it.
If the instrument was used at a place where soluble cutting oil contamination was likely, be sure to perform rust prevention treatment after cleaning.
2. Unlock the clamp and store the instrument in a room free of excessive heat and moisture.
3. When storing the instrument for a long time, apply a rust preventing light oil to the spindle as a rust prevention treatment and remove the battery.

Digimatic Holtest (Three-point Bore Micrometers)



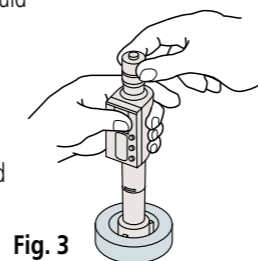
Before Use

1. Remove dust or dirt from the anvils.
2. Check to see whether the thimble moves smoothly without any jamming or unevenness by rotating it all the way through its range. Also check that the anvils move in and out smoothly without sticking. Expose the anvils to the maximum measuring length to make sure there is no oil, chips, or other foreign matter stuck to the bearing surfaces. If there is any foreign matter, remove it with a soft cloth such as gauze.
3. Do not let the bottom of the measuring head touch anything when setting the reference point or measuring. If the bottom touches anything when you are measuring a workpiece, the inclination of the surface that the bottom touches could cause the contact points not to touch parallel to the workpiece, which can lead to measurement errors.
4. If measuring using only the tip of the anvil, make sure to set the zero point at the same bore depth within the calibrated setting ring. (Fig. 1)
5. Note that if the measuring head is replaced, the accuracy specification is no longer guaranteed.
6. Replace button cell with an SR44 type if necessary (Order No.938882).
7. Enter the preset value (setting ring calibration value) if making absolute measurements.
8. When replacing the battery cap, make sure that the seal is properly seated. (Fig. 2)



During Use

1. To apply measuring force, bring the measuring faces into light contact with the workpiece and hold there. Then, rotate the ratchet 5 to 6 stops to apply a constant force. (Fig. 3)
2. Do not let the bottom of the measuring head touch anything when setting the reference point or measuring. If the bottom touches anything when you are measuring a workpiece, the inclination of the surface that the bottom touches could cause the contact points not to touch parallel to the workpiece, which can lead to measurement errors.
3. Make sure that the bearing surfaces of the anvils are always protected from impact.
4. If any error occurs or the count is displayed abnormally, remove the battery and reinstall it.
5. Only perform measurement within the measuring range.

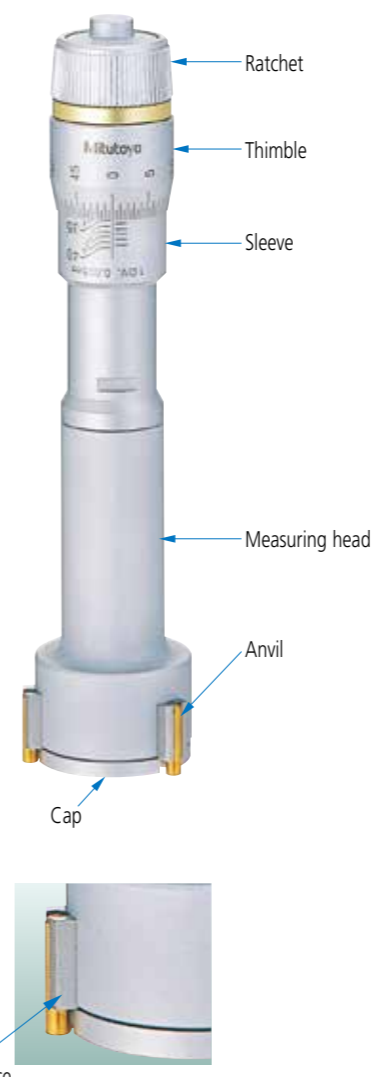


If the instrument is damaged due to being dropped or struck hard, or for any other reason, do not use it and contact us for repair.

After Use

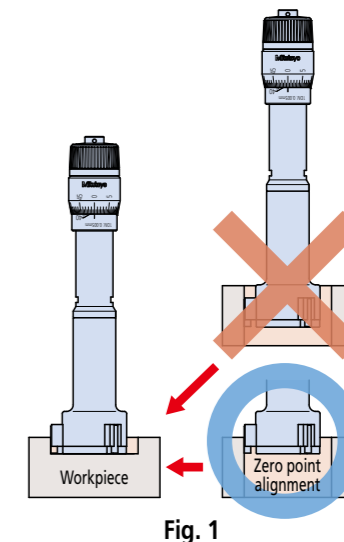
1. Check for damage to the instrument and clean it. In particular, if any foreign matter is stuck to the bearing surface of the anvil, remove it with a soft cloth such as gauze.
2. Store the instrument in a room free of excessive heat and moisture, also dust and oil mist.
3. When storing the instrument for a long time, apply a rust preventing light oil to the anvils as a rust prevention treatment and remove the battery.

Holtest (Two-point/Three-point Bore Micrometers)



Before Use

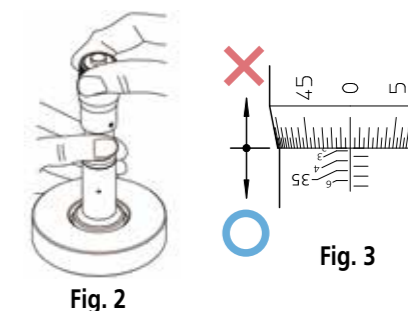
1. Remove dust or dirt from the anvils.
2. Check to see whether the thimble moves smoothly without any jamming or unevenness by rotating it all the way through its range. Also check that the anvils move in and out smoothly without sticking. Expose the anvils to the maximum measuring length to make sure there is no oil, chips, or other foreign matter stuck to the bearing surfaces. If there is any foreign matter, remove it with a soft cloth such as gauze.
3. Do not let the bottom of the measuring head touch anything when setting the reference point or measuring. If the bottom touches anything when you are measuring a workpiece, the inclination of the surface that the bottom touches could cause the contact points not to touch parallel to the workpiece, which can lead to measurement errors.
4. If measuring at the tip of the anvil, make sure to align the zero point at the same bore depth within the calibrated setting ring. (Fig. 1)
5. Note that if the measuring head is replaced, the accuracy specification is no longer guaranteed.



Anvil bearing surface

During Use

1. To apply measuring force, bring the measuring faces into light contact with the workpiece and hold there. Then, rotate the ratchet 5 to 6 stops to apply a constant force. (Fig. 2)
2. Do not let the bottom of the measuring head touch anything when setting the reference point or measuring. If the bottom touches anything when you are measuring a workpiece, the inclination of the surface that the bottom touches could cause the contact points not to touch parallel to the workpiece, which can lead to measurement errors.
3. Make sure that the bearing surfaces of the anvils are always protected from impact.
4. Only perform measurement within the measuring range. (Fig. 3)



If the instrument is damaged due to being dropped or struck hard, or for any other reason, do not use it and contact us for repair.

After Use

1. Check for damage to the instrument and clean it. In particular, if any foreign matter is stuck to the bearing surface of the anvil, remove it with a soft cloth such as gauze.
2. Store the instrument in a room free of excessive heat and moisture, also dust and oil mist.
3. When storing the instrument for a long time, apply a rust preventing light oil to the anvils as a rust prevention treatment.



Before Use

1. Clean the contact point and anvil with a dry cloth.
2. Securely tighten the clamp screw to lock the gage in position. If the gage still moves, clean the gage stem and clamp screw.
3. Set the zero point before starting measurement.
To perform initial setting with an outside micrometer, position the micrometer in the vertical orientation with the spindle of the micrometer and anvil of the gage as shown. (Fig. 1)
4. Mitutoyo provides a useful tool, the bore gage checker (Order No.515-590), for zero-point adjustment. (Photo 1)

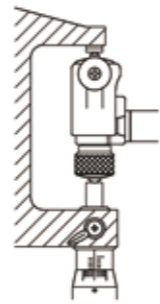


Fig. 1



Photo 1

During Use

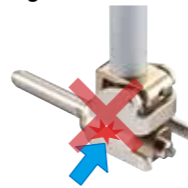
1. To insert the bore gage into the hole to be measured, or a setting ring, tilt the handle so that the guides enter first followed by the anvil as shown. (Fig. 2)

Fig. 2



2. If the measuring face is scratched, etc. by bore gage measurement, it may be covered by special treatment provided by Mitutoyo, such as measuring force or guide supporting force adjustment or replacement of the contacting sphere. Please contact us.
3. For bore gages for blind holes (511-4XX, 511-4XX-20), do not apply force to the guide section in the transverse direction. (Fig. 3)

Fig. 3



If the instrument dropped or struck hard, or for any other reason, do not use it and contact us for repair.

After Use

1. Check for damage to the instrument and clean it.
2. If it is suspected that contamination is present inside the measuring or the sliding section, Use a pair of circlip pliers to disassemble the head, then clean the inside with an alcohol solution. When disassembling the head, be careful not to lose or damage the parts inside, as the internal springs may cause them to pop out. (Fig. 4) After cleaning, dry completely and apply a film of a rust preventing light oil to the contact point and the driver pin.
3. Store the instrument in a room free of excessive heat and moisture, also dust and oil mist.

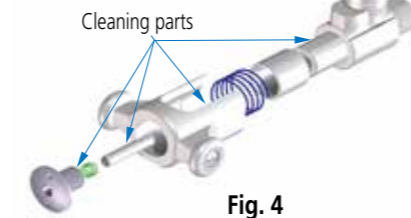
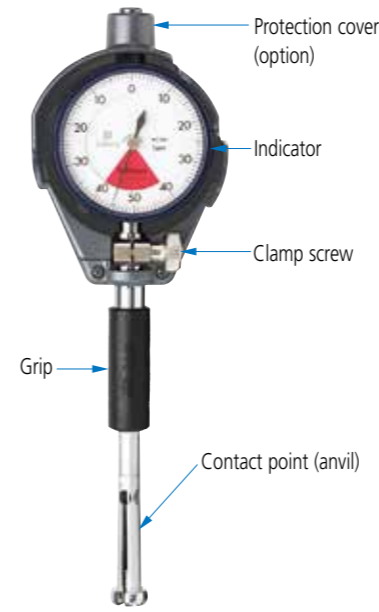


Fig. 4



Before Use

1. Clean the contact point (anvil) with a dry cloth.
2. Avoid large temperature changes such as may occur when transferring the instrument from outside a room to inside, or vice versa. Otherwise condensation may form and corrode the contact point (anvil) and/or measuring pin, which may result in malfunction.
3. Securely tighten the clamp screw to lock the gage in position. If the gage still moves, clean the gage stem and clamp screw.
4. Set the zero point before starting measurement. To set the zero point with an outside micrometer, position the micrometer in the vertical orientation with the spindle of the micrometer as shown. (Fig. 1)

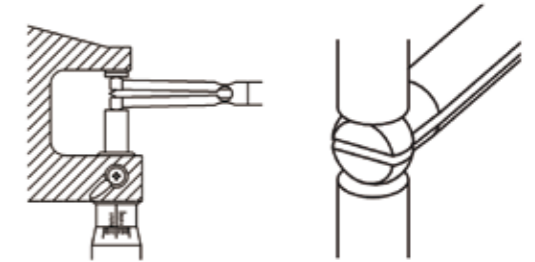
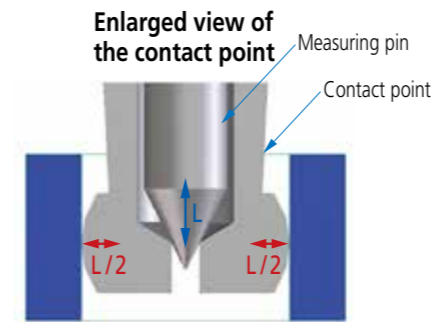


Fig. 1



During Use

1. When replacing the contact point (anvil), use the special spanner. (Fig. 2)



Fig. 2

2. When replacing the contact point (anvil), hold the screw end so that the contact point does not close. (Photo 1)



Photo 1

If the instrument is damaged due to being dropped or struck hard, or for any other reason, do not use it and contact us for repair.

After Use

1. Check for damage to the instrument and clean it with dry cloth, etc.
2. If it is suspected that contamination is present inside the measuring section, remove the contact point (anvil) using the special spanner, and clean the contact point (anvil) by dipping into an alcohol solution. After cleaning, dry completely and apply a thin layer of a rust preventing light oil to the contact point (anvil). (Fig. 2)
3. Store the instrument in a room free of excessive heat and moisture, also dust and oil mist.

ABSOLUTE Digimatic Bore Gage CG-D

Before Use

1. Clean the contact point and anvil with a dry cloth.
2. When setting up the measuring range using spacers on the anvil, always use the minimum number of spacers possible. (Fig. 1)
3. Replace button cell with an SR44 type if necessary (Order No.938882).
4. Make sure that the serial numbers of the display unit and the measuring unit are the same. If they are different then the accuracy specification cannot be guaranteed.
5. Make sure to engage the locating pin with the corresponding groove when connecting an extension rod (optional) (Figs. 2 and Figs. 3).
6. Make sure to perform the initial setting before starting measurement. To do this with an outside micrometer, keep the micrometer in the vertical orientation and position the anvil on the spindle as shown. (Fig. 4)
7. Mitutoyo provides a useful tool, the bore gage checker (Order No.515-590) for initial setting. (Photo 1)

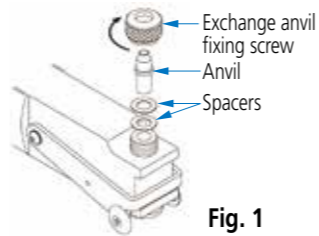


Fig. 1



Fig. 2

Fig. 3

Fig. 4

Photo 1

During Use

1. To measure a hole or bore, insert the guided side first followed by the anvil side. (Photo 2)
2. When measuring a hole or bore in the horizontal orientation, use with the anvil side downward.
3. When reconnecting the extension rod (option) after removing it once, make sure to perform the initial setting again.



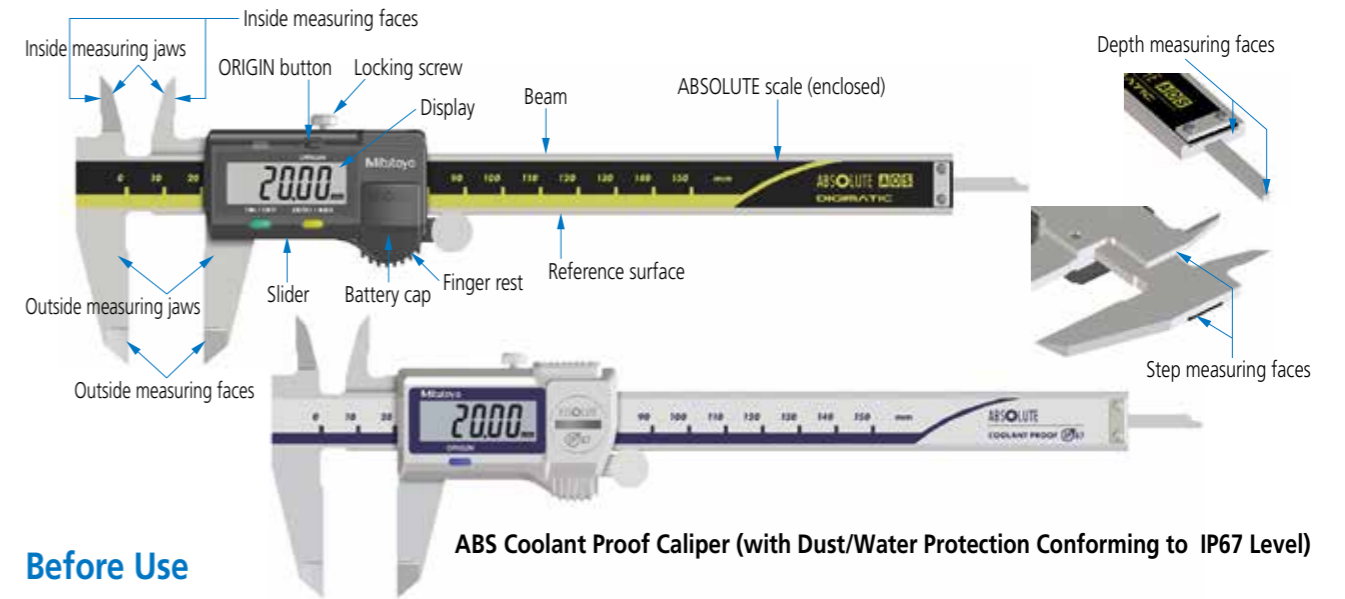
Photo 2

If the instrument is damaged due to being dropped or struck hard, or for any other reason, do not use it and contact us for repair.

After Use

1. Check for damage to the instrument and clean it.
2. Store the instrument in a room free of excessive heat and moisture, also dust and oil mist.
3. Do not clean the contact point by disassembling.

ABSOLUTE Digimatic Calipers



Before Use

1. Use a small amount of a rust preventing light oil to wipe the reference surface of the beam.
2. Move the slider all the way along the main beam to check whether the slider moves smoothly without jamming.
3. Install an SR44 battery (Order No.938882) with the positive side of the battery uppermost. (Fig. 1)
4. After the battery is replaced, clean the measuring faces and bring them into contact. Then press the ORIGIN button to perform the zero point setting. (Fig. 2)
5. Close the measuring faces after cleaning, and check the following:
 - Outside measuring faces: They are in good condition if light cannot be seen between them when they are held to the light. (Fig. 3)
 - If contamination or burrs exist on the faces they will not close together and light will be seen between them. (Fig. 4)
 - Inside measuring faces: They are in good condition if a small amount of light can be seen between them when they are held to the light.
6. If the instrument is used in the environment exposed to oil (mist) and dirt, it is recommended to use the Coolant Proof Caliper with Dust/Water Protection model.

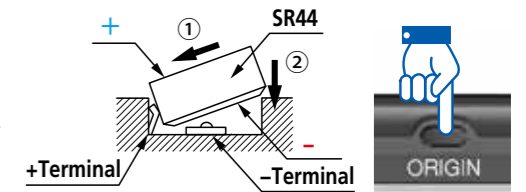


Fig. 1

Fig. 2

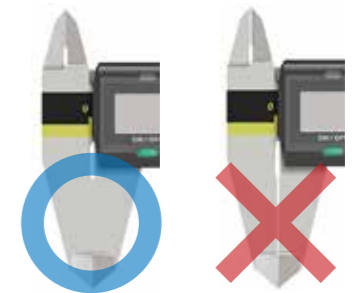


Fig. 3

Fig. 4

During Use

1. Make sure to apply constant force during measurement, and measure an object as close as possible to the root of the jaws. It is better to avoid measurement with the tip of the jaws. (Fig. 5)
2. Do not measure an object with the measuring faces tilted. (Fig. 6)

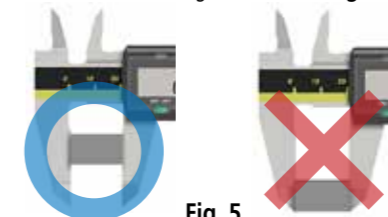


Fig. 5



Fig. 6

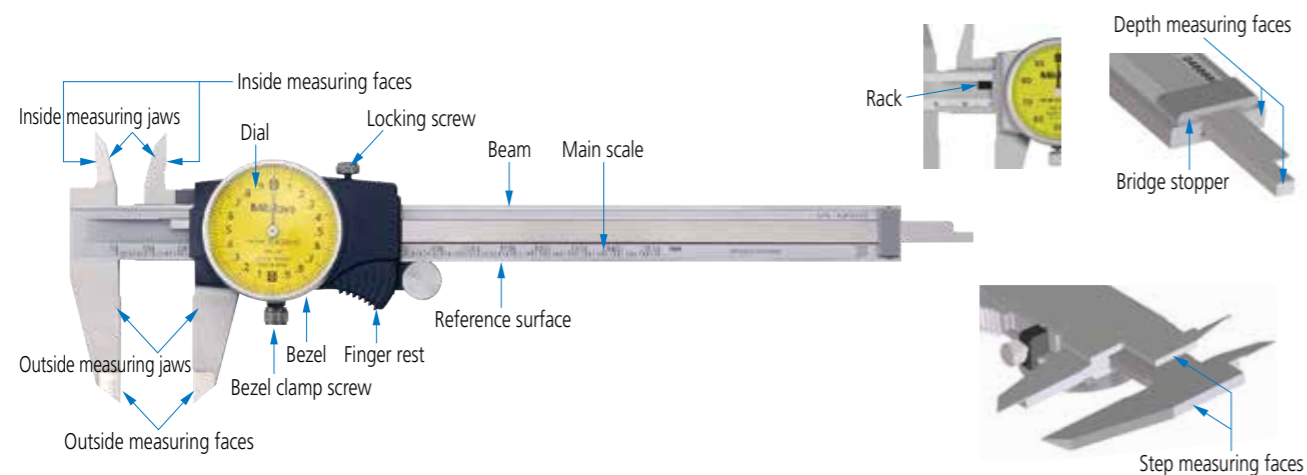
If the instrument is damaged due to being dropped or struck hard, or for any other reason, do not use it and contact us for repair.

After Use

1. Check for damage to the instrument and clean it. If the instrument, whether it is dust/water protection model or not, is used at a place where soluble cutting oil or the like is used, be sure to perform rust prevention treatment after cleaning.
2. Open the outside measuring jaws by approximately 0.2 to 2 mm, leave the locking screw untightened, and then store the instrument. (Fig. 7)
3. Store the instrument in a room free of excessive heat and moisture, also dust and oil mist.
4. When storing the instrument for a long time, be sure to remove the battery.

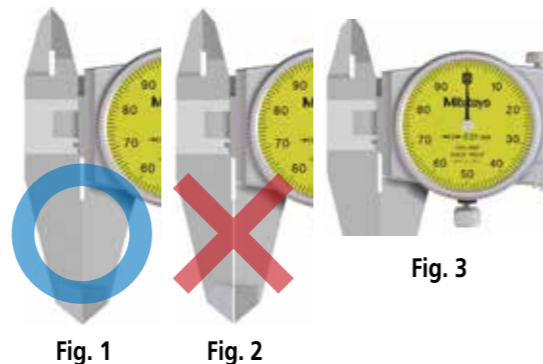


Fig. 7



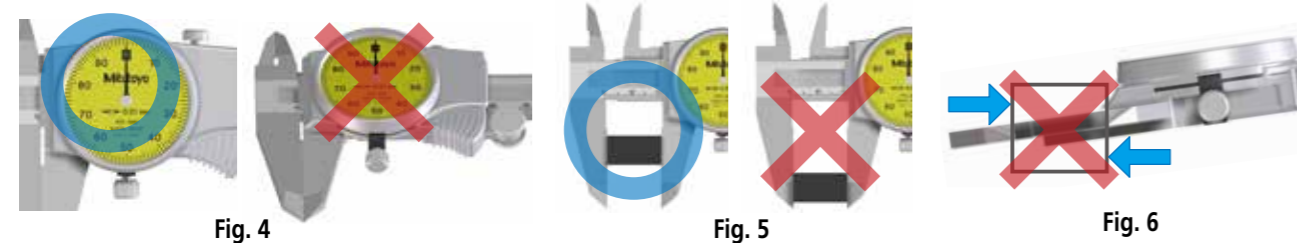
Before Use

1. Use a small amount of a rust preventing light oil to wipe the reference surface of the beam.
2. Move the slider all the way along the main beam to check whether the slider moves smoothly without jamming.
3. Close the measuring faces after cleaning, and check the following:
 - Outside measuring faces: They are in good condition if light cannot be seen between them when they are held to the light. (Fig. 1)
 - If contamination or burrs exist on the faces they will not close together and light will be seen between them. (Fig. 2)
 - Inside measuring faces: They are in good condition if a small amount of light can be seen between the faces when they are held to the light. (Fig. 3)
 - Check the zero point. (Fig. 3)



During Use

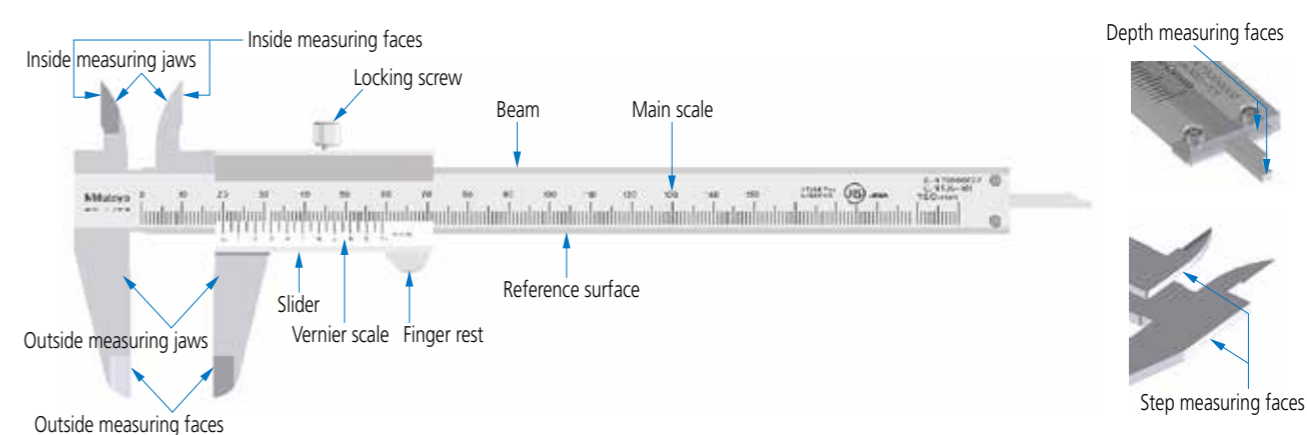
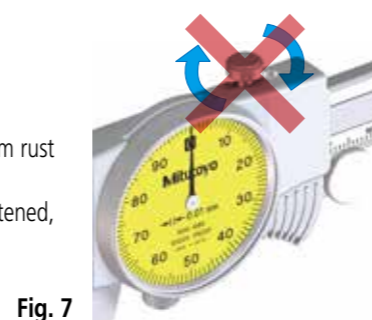
1. Read the graduations from directly above the dial to avoid parallax error. (Fig. 4)
2. Make sure to apply constant force during measurement, and measure an object as close as possible to the root of the jaws. It is better to avoid measurement with the tip of the jaws. (Fig. 5)
3. Do not measure an object with the measuring faces tilted. (Fig. 6)



If the instrument is damaged due to being dropped or struck hard, or for any other reason, do not use it and contact us for repair.

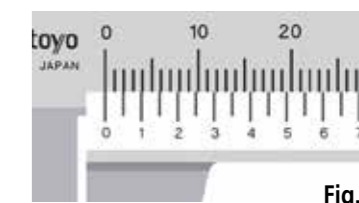
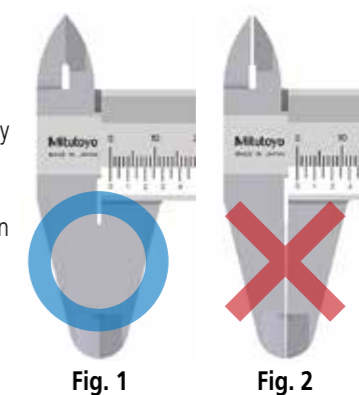
After Use

1. Check for damage to the instrument and clean it.
If the instrument is used at a place where soluble cutting oil or the like is used, be sure to perform rust prevention treatment after cleaning.
2. Open the outside measuring jaws by approximately 0.2 to 2 mm, leave the locking screw untightened, and then store the instrument. (Fig. 7)
3. Store the instrument in a room free of excessive heat and moisture, also dust and oil mist.



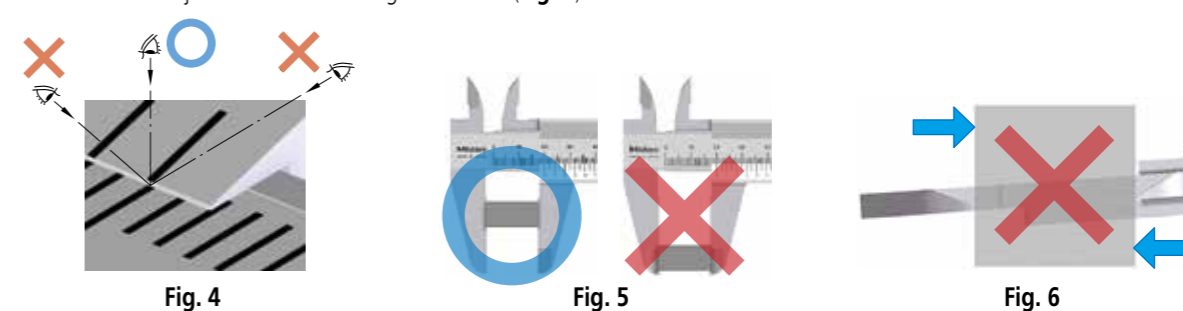
Before Use

1. Use a small amount of a rust preventing light oil to wipe the reference surface of the beam.
2. Move the slider all the way along the main beam to check whether the slider moves smoothly without jamming.
3. After cleaning, check the following by closing the measuring faces:
 - Outside measuring faces: They are in good condition if light cannot be seen between them when they are held to the light. (Fig. 1)
 - If contamination or burrs exist on the faces they will not close together and light will be seen between them. (Fig. 2)
 - Inside measuring faces: They are in good condition if a small amount of light can be seen between the faces when they are held to the light. (Fig. 1)
 - Check the zero point. (Fig. 3)



During Use

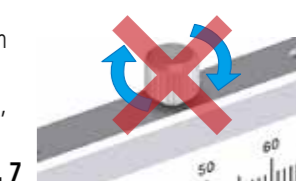
1. Read the scale graduations from directly above the dial to avoid parallax error. (Fig. 4)
2. Make sure to apply constant force during measurement, and measure an object as close as possible to the root of the jaws. It is better to avoid measurement with the tip of the jaws. (Fig. 5)
3. Do not measure an object with the measuring faces tilted. (Fig. 6)



If the instrument is damaged due to being dropped or struck hard, or for any other reason, do not use it and contact us for repair.

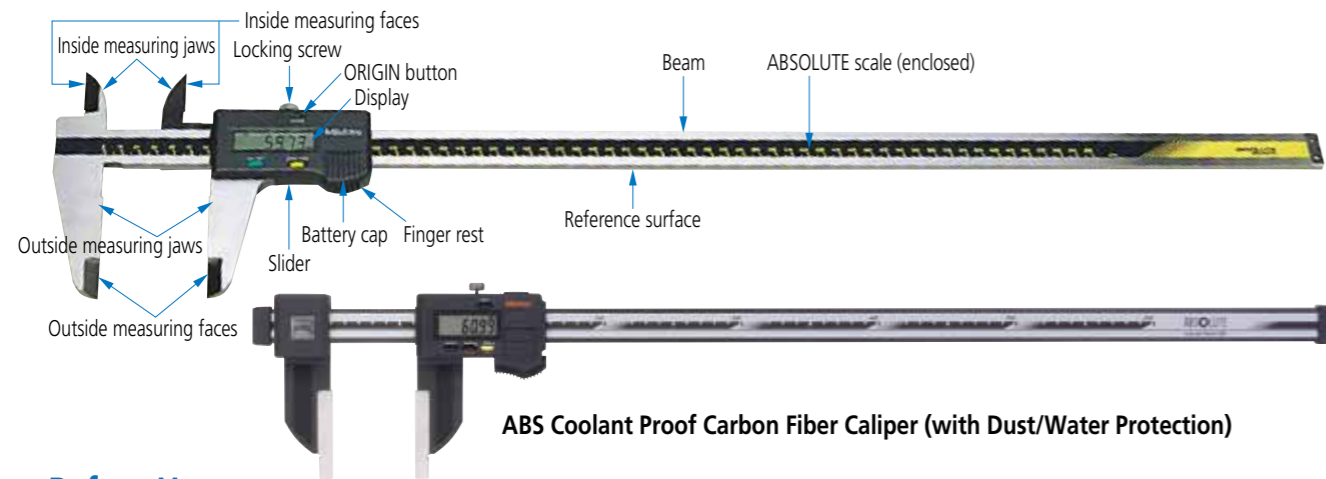
After Use

1. Check for damage to the instrument and clean it.
If the instrument is used at a place where soluble cutting oil or the like may attach, be sure to perform rust prevention treatment after cleaning.
2. Open the outside measuring jaws by approximately 0.2 to 2 mm, leave the locking screw untightened, and then store the instrument. (Fig. 7)
3. Store the instrument in a room free of excessive heat and moisture, also dust and oil mist.



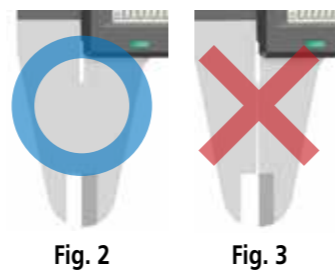
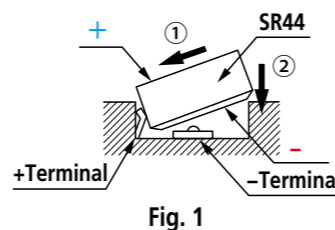
Calipers

Long ABSOLUTE Digimatic Calipers



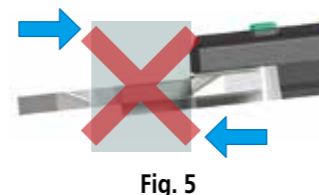
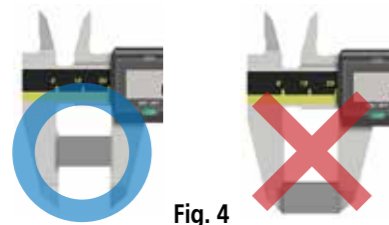
Before Use

1. Use a small amount of a rust preventing light oil to wipe the reference surface of the beam.
2. Move the slider all the way along the beam to check whether the slider moves smoothly without jamming.
3. Install an SR44 battery (**Order No.938882**) with the positive side of the battery uppermost. (**Fig. 1**)
4. After the battery is replaced, clean the measuring faces and bring them into contact. Then press the ORIGIN button to set the zero point.
5. Close the measuring faces after cleaning, and check the following:
 - Outside measuring faces: They are in good condition if light cannot be seen between them when they are held to the light. (**Fig. 2**)
 - If contamination or burrs exist on the faces they will not close together and light will be seen between them. (**Fig. 3**)
 - Inside measuring faces: They are in good condition if a small amount of light can be seen between them when they are held to the light.
6. If the instrument is used in the environment exposed to oil (mist) and dirt, it is recommended to use the Coolant Proof Caliper with Dust/Water Protection model.



During Use

1. Make sure to apply constant force during measurement, and measure an object as close as possible to the root of the jaws. It is better to avoid measurement with the tip of the jaws. (**Fig. 4**)
2. For a large caliper, it is recommended to operate measurement with two people, one person to make the measurement and one person to support the caliper. This will minimize bending of the reference surface of the beam and therefore minimize measurement error from this cause.
3. Do not measure an object with the measuring faces tilted. (**Fig. 5**)



If the instrument is damaged due to being dropped or struck hard, or for any other reason, do not use it and contact us for repair.

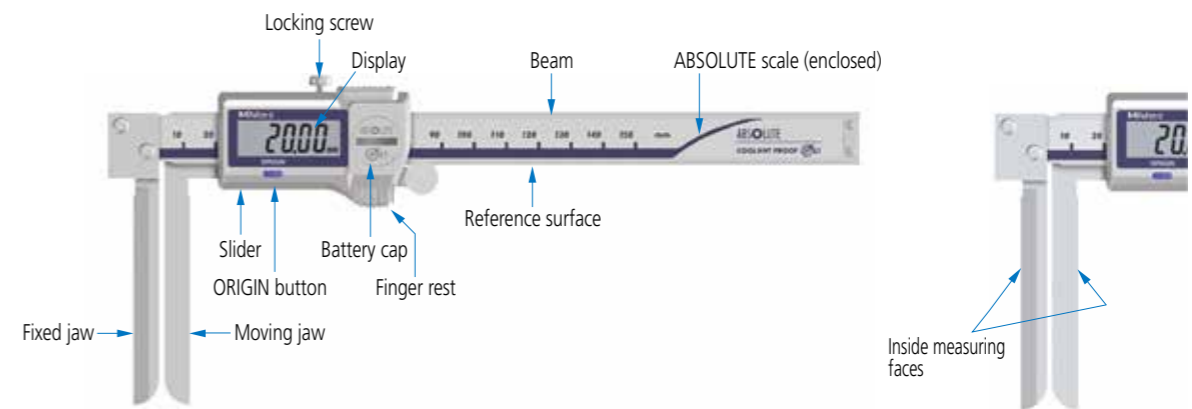
After Use

1. Check for damage to the instrument and clean it.
If the instrument, whether it is dust/water protection model or not, is used at a place where soluble cutting oil or the like is used, be sure to perform rust prevention treatment after cleaning.
2. Open the outside measuring jaws by approximately 0.2 to 2 mm, leave the locking screw untightened, and then store the instrument. (**Fig. 6**)
3. Store the instrument in a room free of excessive heat and moisture, also dust and oil mist.
4. When storing the instrument for a long time, be sure to remove the battery.



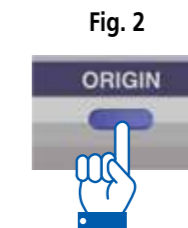
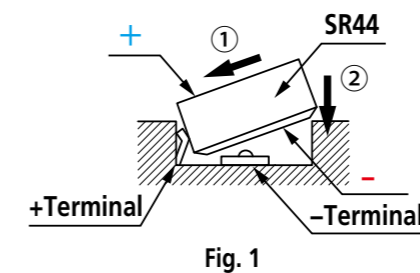
Calipers

ABSOLUTE Coolant Proof Inside Calipers



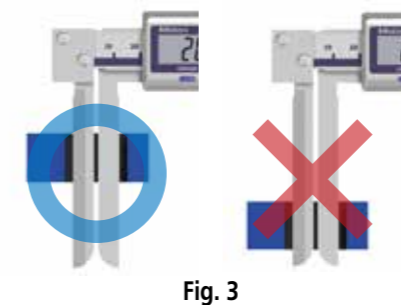
Before Use

1. Use a small amount of a rust preventing light oil to wipe the reference surface of the beam.
2. Move the slider all the way to check whether the slider moves smoothly without jamming.
3. Install an SR44 battery (**Order No.938882**) with the positive side of the battery uppermost. (**Fig. 1**)
4. When starting the measurement, or replacing the battery, clean the measuring surfaces and bring them lightly together. Then press the ORIGIN switch to set the origin. (**Fig. 2**)



During Use

1. Make sure to apply constant force during measurement, and measure an object as close as possible to the root of the jaws. It is better to avoid measurement with the tip of the jaws. (**Fig. 3**)
2. Do not measure an object with the measuring faces tilted. (**Fig. 4**)



If the instrument is damaged due to being dropped or struck hard, or for any other reason, do not use it and contact us for repair.

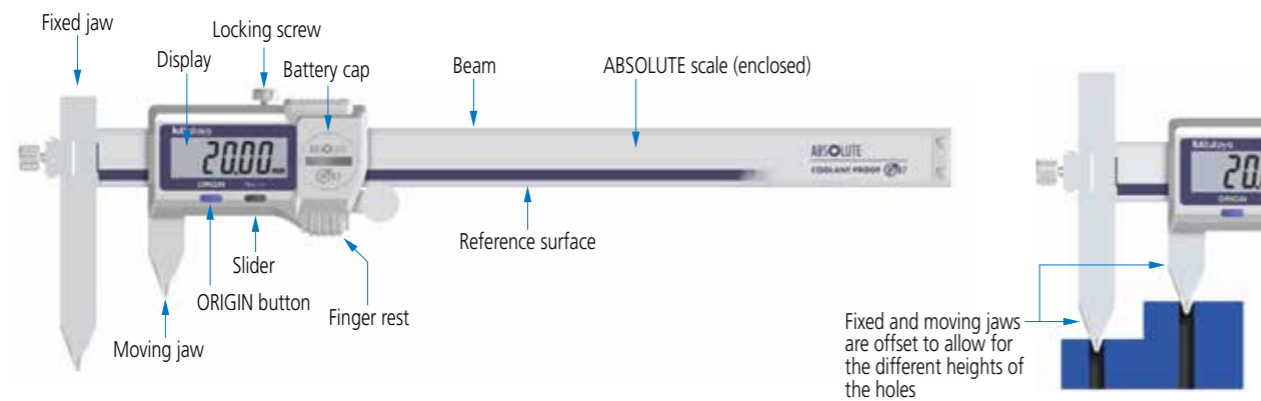
After Use

1. Check for damage to the instrument and clean it.
If the instrument is used at a place where soluble cutting oil or the like is used, be sure to perform rust prevention treatment after cleaning.
2. Open the outside measuring jaws by approximately 0.2 to 2 mm, leave the locking screw untightened, and then store the instrument. (**Fig. 5**)
3. Store the instrument in a room free of excessive heat and moisture, also dust and oil mist.
4. When storing the instrument for a long time, be sure to remove the battery.



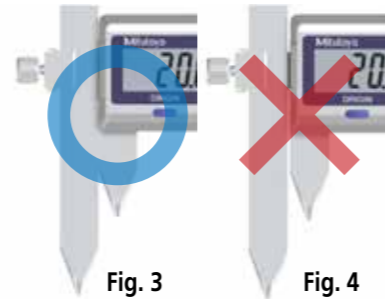
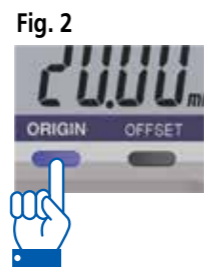
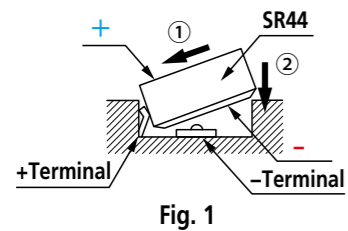
Calipers

ABSOLUTE Coolant Proof Offset Centerline Calipers



Before Use

1. Use a small amount of a rust preventing light oil to wipe the reference surface of the beam.
2. Move the slider all the way to check whether the slider moves smoothly without jamming.
3. Install an SR44 battery (Order No.938882) with the positive side of the battery uppermost. (Fig. 1)
4. When starting the measurement, or replacing the battery, clean the measuring surfaces and bring them into contact. Then press the ORIGIN switch to set the origin. (Fig. 2)
5. Check the following by contacting the fixed jaw and the moving jaw:
 - Contact surfaces: They are in good condition if light cannot be seen between them when they are held to the light. (Fig. 3)
 - If contamination or burrs exist on the faces they will not close together and light will be seen between them. (Fig. 4)



During Use

1. Make sure to apply consistent force on all measurements, and stabilize the measuring faces. (Fig. 5)
2. Do not measure an object with the measuring faces tilted. (Fig. 6)



If the instrument is damaged due to being dropped or struck hard, or for any other reason, do not use it and contact us for repair.

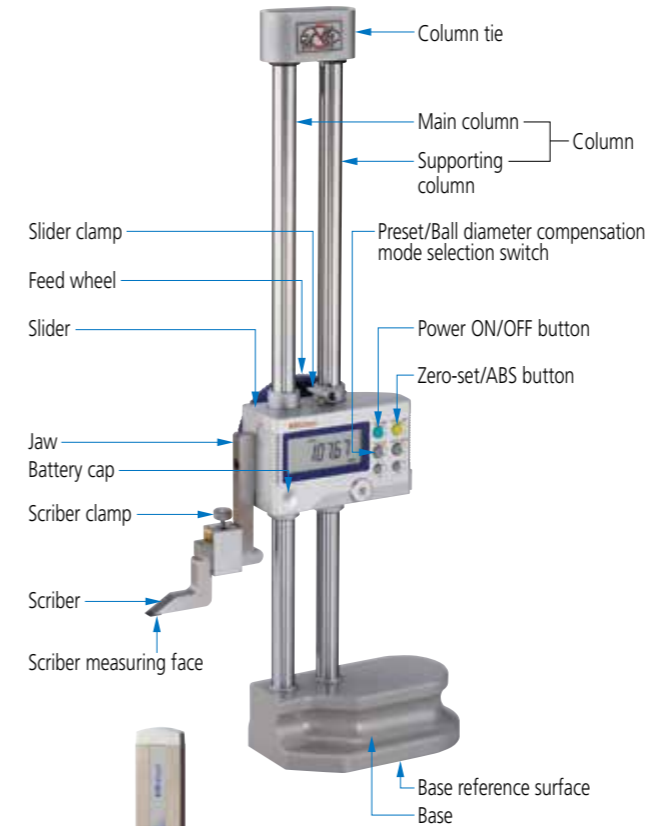
After Use

1. Check for damage to the instrument and clean it. If the instrument is used at a place where soluble cutting oil or the like is used, be sure to perform rust prevention treatment after cleaning.
2. Open the moving jaws by approximately 0.2 to 2 mm, leave the locking screw untightened, and then store the instrument. (Fig. 7)
3. Store the instrument in a room free of excessive heat and moisture, also dust and oil mist.
4. When storing the instrument for a long time, be sure to remove the battery.



Height Gages

Digimatic Height Gages



Before Use

1. Set the scriber as close to the main column as possible.
 2. Clean the columns, base reference surface, scriber mounting surface, and scriber measuring face.
 3. Clean the precision granite surface plate on which the height gage will be used.
 4. Move the slider throughout its range to check that the movement is smooth without jamming.
 5. Install an SR44 battery (Order No.938882) with the positive side of the battery uppermost. (Fig. 1)
 6. After the battery is replaced, bring the measuring face of the scriber into contact with the surface plate and press the PRESET button to perform the zero point setting. For ABSOLUTE Digimatic Height Gages, perform zero setting by pressing the ORIGIN button after bring a scriber measuring face contact with the base reference surface.
- * When carrying the instrument hold it with both hands with one on the slider, and the other on the base. (Photo 1)

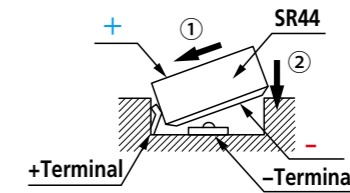


Fig. 1

Photo 1

During Use

1. During measurement, rotate the feed wheel slowly when applying a constant measuring force. (Photo 2)
- **Coarse/fine feed switching**
Coarse feed or fine feed can be selected by pulling or pushing the handle of the slider feed wheel. (Fig. 2)

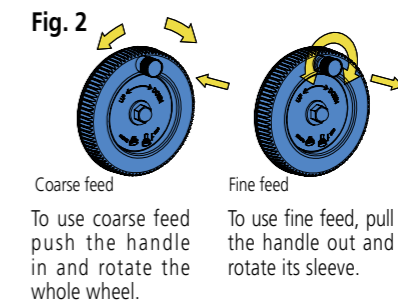


Photo 2

If the instrument is damaged due to being dropped or struck hard, or for any other reason, do not use it and contact us for repair.

After Use

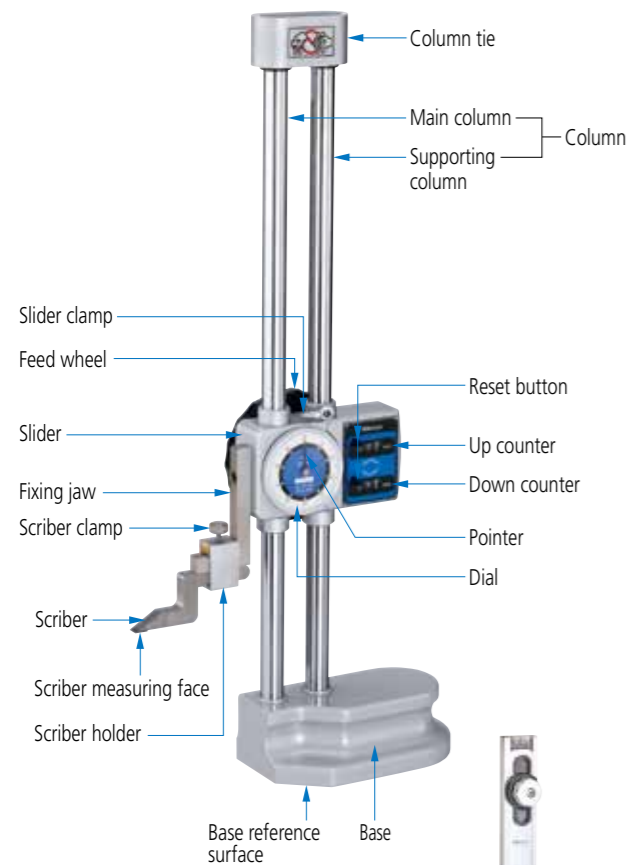
1. Check for damage to the instrument and clean it.
2. When the height gage will not be used for some time leave the scriber unclamped and just above, but not touching, the surface plate. This is to avoid risk of personal injury by accidental contact with the scriber tip.
3. Be especially careful not to let the scriber protrude over the edge of the surface plate at any time. (Photo 3)
4. Be sure to turn off the power before storing.
5. Store the instrument in a room free of excessive heat and moisture, also dust and oil mist.
6. If the instrument will not be used for a long time, remove the battery before storage and cover the unit with the supplied dust cover.



Photo 3

Height Gages

Dial Height Gages



Vernier Height Gage

Before Use

1. Set the scriber as close to the main column as possible.
2. Clean the columns, base reference surface, scriber mounting surface, and scriber measuring face.
3. Clean the precision granite surface plate on which the height gage will be used.
4. Move the slider throughout its range to check that the movement is smooth without jamming.
5. Bring the measuring face of the scriber into contact with the surface plate and set the dial pointer and counters at zero to perform the zero point setting. (Fig. 1)

* When carrying the instrument hold it with both hands with one on the slider, and the other on the base. (Photo 1)

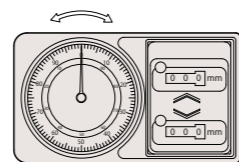


Fig. 1



Photo 1

During Use

1. Read the dial graduations from directly above to avoid parallax error. (Fig. 2)
2. During measurement, rotate the feed wheel slowly when applying a constant measuring force. (Photo 2)



Photo 2

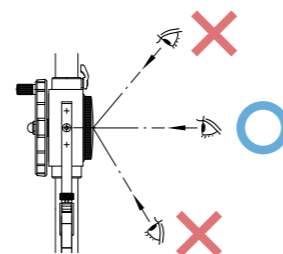


Fig. 2

If the instrument is damaged due to being dropped or struck hard, or for any other reason, do not use it and contact us for repair.

After Use

1. Check for damage to the instrument and clean it.
If the instrument is used at a place where soluble cutting oil or the like is used, be sure to perform rust prevention treatment after cleaning.
2. When the height gage will not be used for some time leave the scriber unclamped and just above, but not touching, the surface plate. This is to avoid risk of personal injury by accidental contact with the scriber tip.
3. Be especially careful not to let the scriber protrude over the edge of the surface plate at any time. (Photo 3)
4. If the instrument will not be used for a long time, cover the unit with the supplied dust cover.
5. Store the instrument in a room free of excessive heat and moisture, also dust and oil mist.

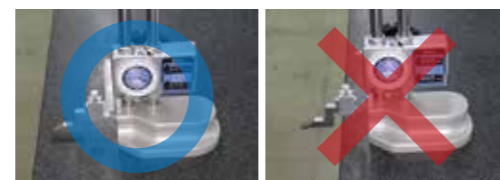
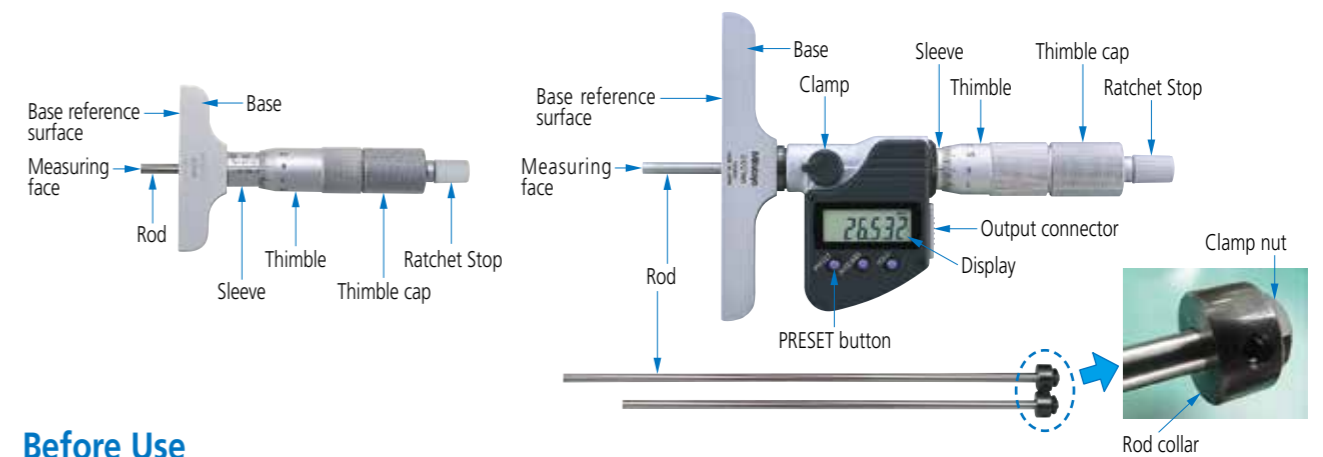


Photo 3

Depth Gages

Depth Micrometers (Interchangeable Rod Type)



Before Use

1. Check to see whether the thimble moves smoothly without any jamming or unevenness by rotating it all the way through its range.
2. For a digimatic type, replace button cell with an SR44 type if necessary (Order No.938882).
3. Remove dust or dirt from the reference surface and measuring surface.
4. Slowly contact the measuring surfaces while pressing the reference surface against a flatness-assured surface such as precision surface plate. Then, rotate the ratchet 3 to 5 stops to apply a constant force to check the zero-point.
If the reference point is over 25mm, use gauge blocks to check the setting. (Fig. 1)
If the reference point is off, align the zero point by rotating the sleeve.
5. When changing the rods, remove dust or dirt from the contacting surfaces on the rod collar and spindle end. (Photo 1)
6. When tightening the output connector cover and battery ensure that the seals are correctly seated so that they do not protrude (only for Digimatic models). (Fig. 2)

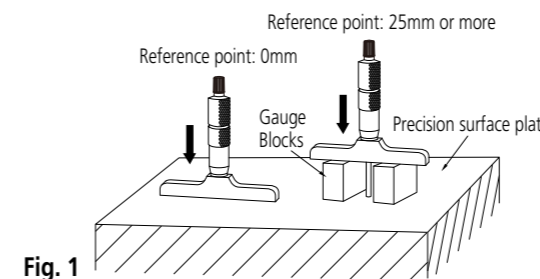


Fig. 1



Photo 1 Parts to be cleaned

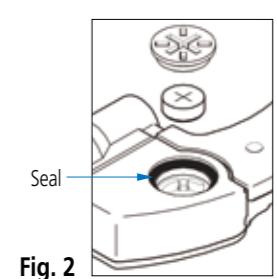


Fig. 2

During Use

1. Do not retract the spindle too far past the upper limit of the measuring range, as this can damage some types of digital micrometer. (Fig. 3)
2. Read the graduations seen directly from above to avoid parallax error. (Fig. 4)
3. The width of the graduation lines represent approximately 2µm to aid in reading to the nearest 1µm. (Fig. 5)
4. If any error occurs or the count is displayed abnormally, remove the battery and reinstall it (only for Digimatic models).
5. Make sure that the rod, the base and the base reference surface are always protected from impact.
6. If using the instrument for an extended period of time, regularly check (and if necessary adjust) the reference point setting to allow for thermal expansion.

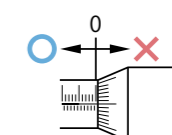


Fig. 3

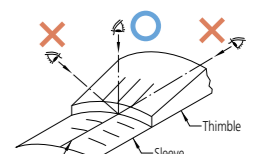


Fig. 4

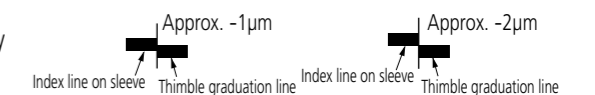


Fig. 5

If the instrument is damaged due to being dropped or struck hard, or for any other reason, do not use it and contact us for repair.

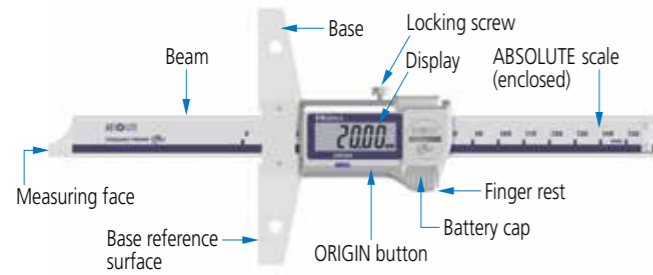
After Use

1. Check for damage to the instrument and clean it. If the instrument was used at a place where soluble cutting oil contamination was likely, be sure to perform rust prevention treatment after cleaning.
2. Release the clamp, and then store the instrument in a room free of excessive heat and moisture, also dust and oil mist.
3. When storing the instrument for a long time, apply a rust preventing light oil to the rod and the base reference surface as a rust prevention treatment and remove the battery.

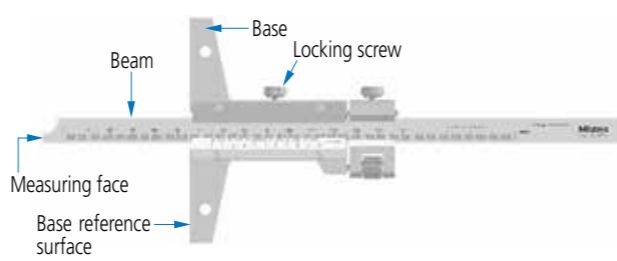
Depth Gages

ABSOLUTE Digimatic and Vernier Depth Gages

ABSOLUTE Digimatic Depth Gage



Vernier Depth Gage



Before Use

1. Use a small amount of a rust preventing light oil to wipe the reference surface of the beam.
2. Move the base all the way along the main beam to check whether the slider moves smoothly without jamming.
At this time, use caution since the vernier-type main scale may separate from the base. (Fig. 1)
3. For a digimatic type, use an SR44 battery (Order No. 938882). (Fig. 2)
4. Set up the origin point on a flatness-assured surface such as precision surface plate. (Fig. 3)
5. If using a vernier-type scale equipped with fine feed, adjust the feed screw so that there is always clearance (feed gap) between the fine feed device and the base. (Fig. 4)

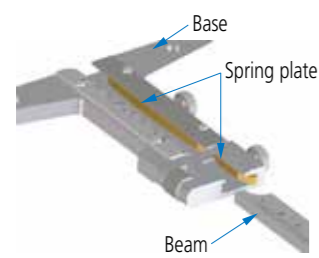


Fig. 1

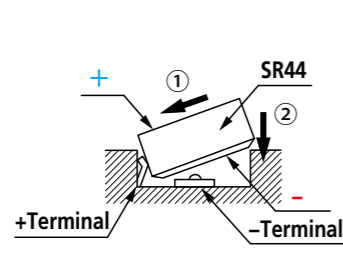


Fig. 2

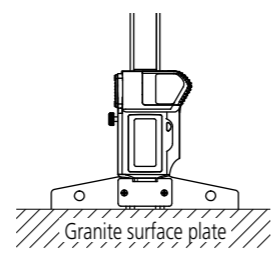


Fig. 3

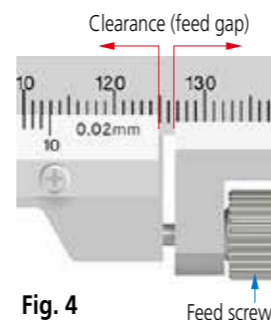


Fig. 4

During Use

1. Perform measurement while the reference surface is fully in contact with the workpiece. (Fig. 5)
2. Read the scale graduations from directly above to avoid parallax error. (Fig. 6)

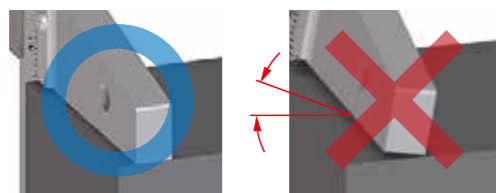


Fig. 5

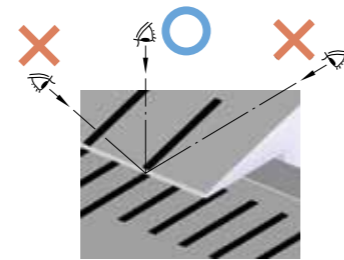


Fig. 6

If the instrument is damaged due to being dropped or struck hard, or for any other reason, do not use it and contact us for repair.

After Use

1. Check for damage to the instrument and clean it with dry cloth, etc.
If the instrument was used at a place where soluble cutting oil or is used, be sure to perform rust prevention treatment after cleaning.
2. Store the instrument in a room free of excessive heat and moisture, also dust and oil mist.
3. When storing the instrument for a long time, be sure to remove the battery.

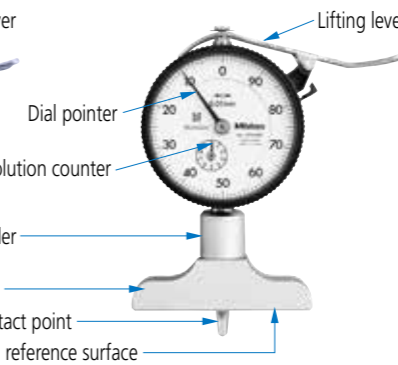
Depth Gages

ABSOLUTE Digimatic and Dial Depth Gages

ABSOLUTE Digimatic Depth Gage



Dial Depth Gage



Before Use

1. Remove dust or dirt from the reference surface and the contact point.
2. Make sure that a washer is in position on the lifting lever fixing part.
3. Move the spindle all the way along the main beam to check whether the spindle moves smoothly without jamming.
4. For a digimatic type, use an SR44 battery (Order No. 938882). (Fig. 1)
5. Use a contact point with a diameter smaller than the diameter of the base hole. (Fig. 2)
6. Set up the reference point on a flatness-assured surface such as a precision surface plate. (Fig. 3)
7. When using extension rods, use a master gauge (or gauge blocks) to set up the reference point. (Fig. 3)

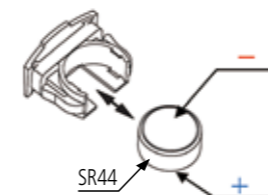


Fig. 1

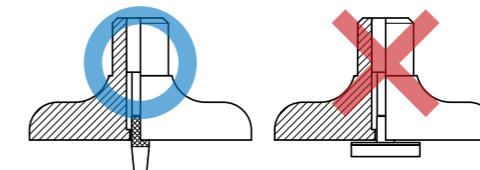


Fig. 2

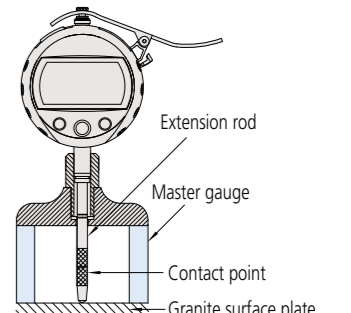


Fig. 3

During Use

1. Do not move the contact point rapidly nor apply force in the transverse direction, otherwise operation and accuracy may be adversely affected. (Fig. 4)
2. For Digimatic types, the letter "E" at the end of the display that appears momentarily during spindle movement does not indicate a fault. However, if it is displayed continuously then repair is necessary. (Fig. 5)
3. Read the scale graduations from directly above to avoid parallax error.
4. If the total length of extension rods exceeds 110mm, use the gage in the vertical orientation (keeping the contact point downward).

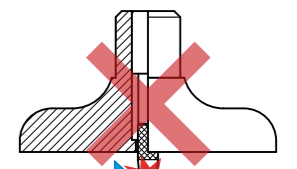


Fig. 4

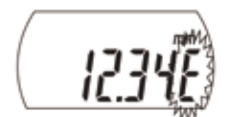


Fig. 5

If the instrument is damaged due to being dropped or struck hard, or for any other reason, do not use it and contact us for repair.

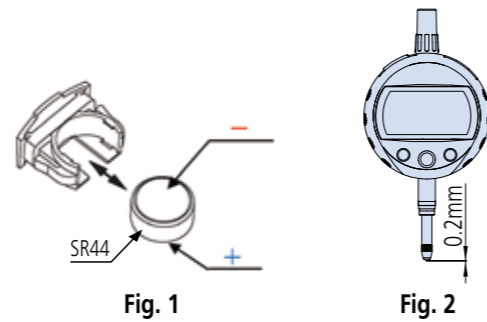
After Use

1. Check for damage to the instrument and clean it with dry cloth, etc.
2. If the instrument is used at a place where soluble cutting oil or is used, be sure to perform rust prevention treatment after cleaning.
3. Store the instrument in a room free of excessive heat and moisture, also dust and oil mist.



Before Use

1. Use a dry cloth or a cloth moistened with alcohol to clean the spindle without lubrication.
2. Move the spindle throughout its range to check that the movement is smooth without stickiness or jamming.
3. Use an SR44 battery (Order No.938882). (Fig. 1)
4. When setting the zero point, retract the spindle at least 0.2mm from the rest position. (Fig. 2)
5. To avoid measuring error due to the cosine effect, ensure that the spindle is accurately aligned with the intended direction of measurement. (Photo 1) Also note that unevenness of the reference surface may cause measuring errors.
6. If the instrument is to be used in an environment thick with oil mist or dust, the water/dust-proof type is recommended.

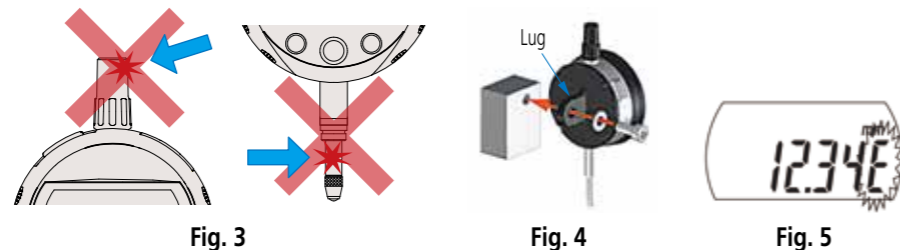


During Use

1. Do not move the spindle rapidly, apply force in the transverse direction nor the cap, otherwise operation and accuracy may be adversely affected. (Fig. 3)
2. Use a holding fixture that will not deflect significantly during normal use.
3. Clamp the lug so that the spindle is square to the measuring face. (Fig. 4)
We offer lifting levers and releases to operate the spindle.
4. The letter "E" appearing temporarily at the end of the display while the spindle is moving is normal. However, if it is displayed continuously when the spindle is at rest then repair is necessary. (Fig. 5)



Photo 1



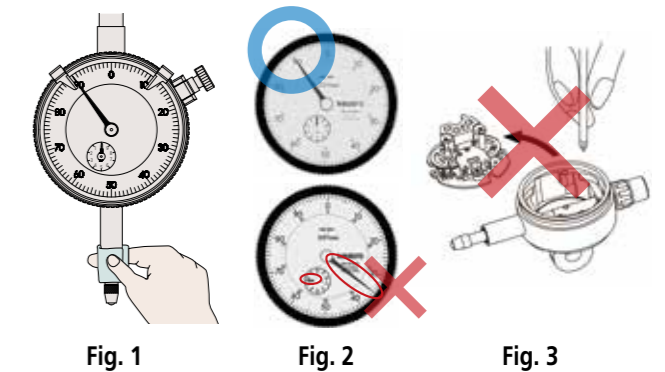
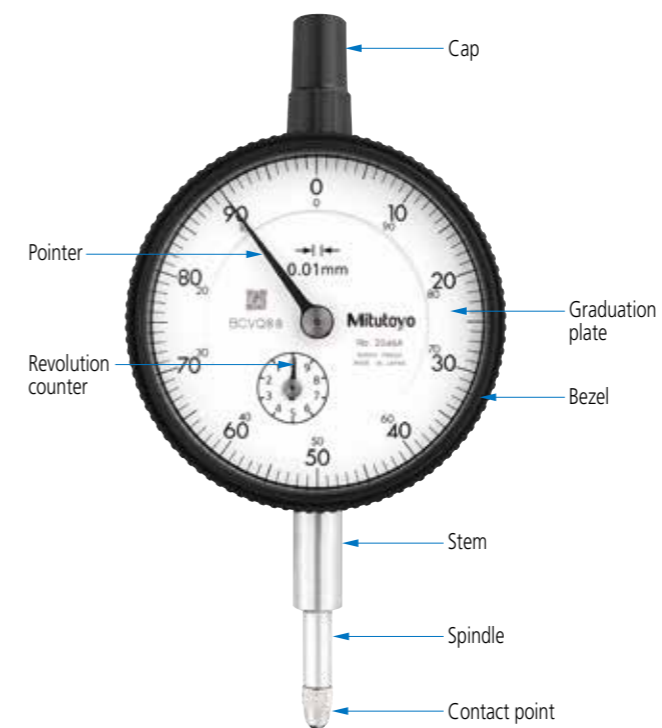
If the instrument is damaged due to being dropped or struck hard, or for any other reason, do not use it and contact us for repair.

After Use

1. Check for damage to the instrument and clean it with dry cloth, etc.
2. Do not lubricate the spindle.
3. If the instrument will not be used for a long time, remove the battery before storage.
4. Store the instrument in a room free of excessive heat and moisture, also dust and oil mist.

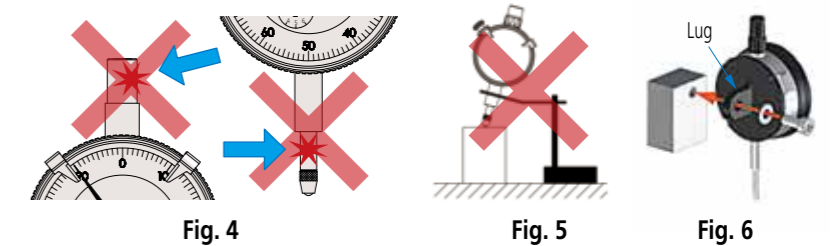
Before Use

1. Use a dry cloth or a cloth moistened with alcohol to clean the spindle without lubrication. (Fig. 1)
2. Make sure that the pointer and the spindle move smoothly.
3. If the pointer and revolution counter are significantly out of position at the rest point (where the spindle is fully extended) (Fig. 2), the spindle or works may be damaged. Contact Mitutoyo for repair without trying to disassemble any part of the works yourself. (Fig. 3)
4. If the instrument is to be used in an environment thick with oil mist or dust, the water/dust-proof type is recommended.



During Use

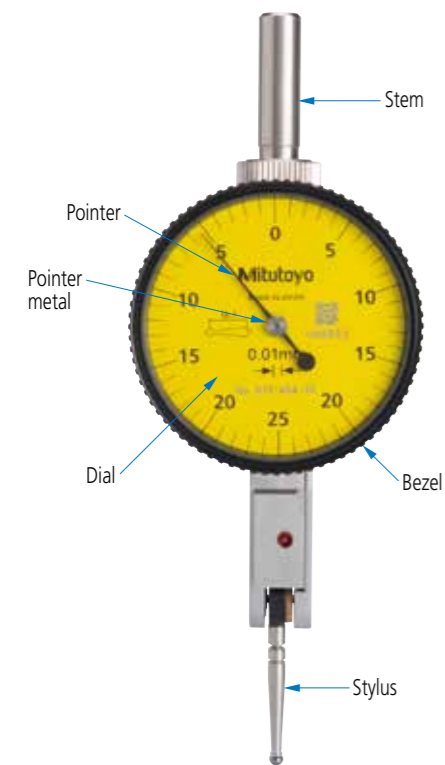
1. Do not move the spindle rapidly nor apply force in the transverse direction, otherwise operation and accuracy may be adversely affected. (Fig. 4)
2. Use a holding fixture that will not deflect significantly during normal use. (Fig. 5)
3. Clamp the lug so that the spindle is square to the measuring face. (Fig. 6)



If the instrument is damaged due to being dropped or struck hard, or for any other reason, do not use it and contact us for repair.

After Use

1. Check for damage to the instrument and clean it with dry cloth, etc.
2. Do not lubricate the spindle.
3. Store the instrument in a room free of excessive heat and moisture, also dust and oil mist.



Before Use

1. Clean the contact point with a dry cloth.
2. Check the bentness of pointer and inclination of pointer metal (Fig. 1). Then, move the stylus throughout its range to check that the movement is smooth without stickiness or jamming.
3. Be sure to use the stylus with standard length according to models, otherwise a large measuring error may be caused (Fig. 2)



Fig. 1



Fig. 2

During Use

1. Use a holding fixture that will not deflect significantly during normal use. (Fig. 3)
2. Do not disassemble or modify the indicator. Failure to observe this may cause inaccuracy or malfunction.
3. A Dial Test Indicator's scale factor depends on the angle between the directions of movement of contact point and workpiece, and is only unity when these are aligned. In practice, to avoid significant error, if the angle θ (Fig. 4) is kept less than 10° during measurement then the effect of a change in scale factor can be ignored. If this angle cannot be kept small then a factor can be applied to the dial reading to compensation for this 'cosine effect' as per the table below.
4. Be sure not to apply force to the bezel and the stylus in lateral direction (Fig. 5). It affects the operation and accuracy.

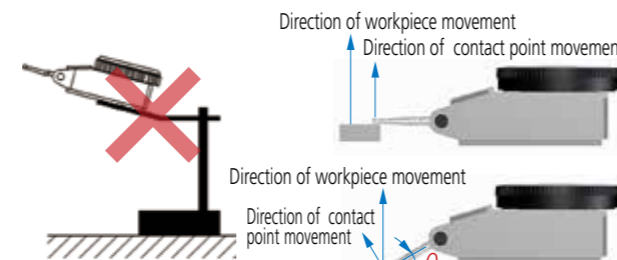


Fig. 3

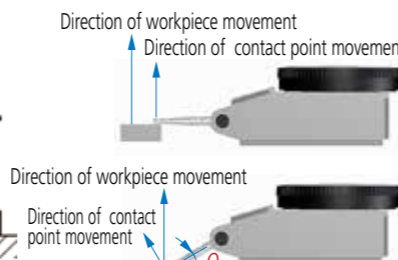


Fig. 4

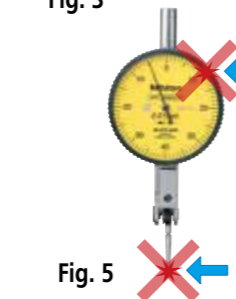


Fig. 5

Angle (θ)	Comp. coefficient (k)
10°	0.98
20°	0.94
30°	0.86
40°	0.76
50°	0.64
60°	0.5

True value (approx. value) = Scale reading \times Comp. coefficient

If the instrument is damaged due to being dropped or struck hard, or for any other reason, do not use it and contact us for repair.

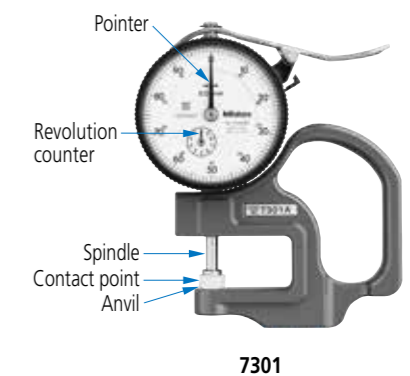
After Use

1. Check for damage to the instrument and clean it with dry cloth, etc.
2. Store the instrument in a room free of excessive heat and moisture, also dust and oil mist.

Digimatic type



Dial type



Before Use

1. Clean the spindle, contact point, and anvil with a dry cloth or one moistened with alcohol.
2. Make sure that a washer is used between the spindle lifting lever and the spindle. (Photo 1)
3. Do not loosen any retaining screws unnecessarily. (The contact point, anvil, back lid, top of spindle, spindle lifting lever, and indicator fixing part)
4. Move the spindle throughout its range to check that the movement is smooth without stickiness or jamming.
5. Check that zero is indicated when the contact point and the anvil are in contact.
6. For a digimatic type, use an SR44 battery (Order No. 938882). (Fig. 1)



Photo 1

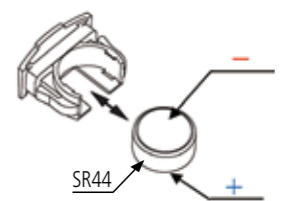


Fig. 1

During Use

1. Do not move the spindle rapidly nor apply force in the transverse direction, otherwise operation and accuracy may be adversely affected. (Fig. 2)
2. The letter "E" appearing temporarily at the end of the display while the spindle is moving is normal. However, if it is displayed continuously when the spindle is at rest then repair is necessary. (Fig. 3)
3. If the zero-point is displaced during measurement, clean the contact point and anvil and reset the zero point.
4. Do not loosen the spindle stem clamping screw.
5. Do not attempt to replace the flat type of contact point. Contact Mitutoyo if replacement is needed.
6. If the instrument is in use for an extended period, regularly reset the zero point to allow for the effect of temperature change on the frame.

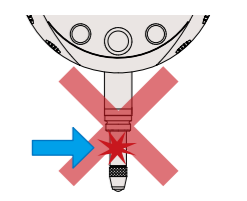


Fig. 2

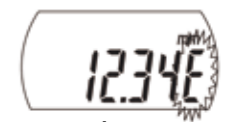


Fig. 3

If the instrument is damaged due to being dropped or struck hard, or for any other reason, do not use it and contact us for repair.

After Use

1. Check for damage to the instrument and clean it with dry cloth, etc.
2. Do not lubricate the spindle.
3. To prevent a flat contact point from wringing to the anvil, insert a piece of oiled paper between them before storage. (Photo 2)
4. Store the instrument in a room free of excessive heat and moisture, also dust and oil mist.



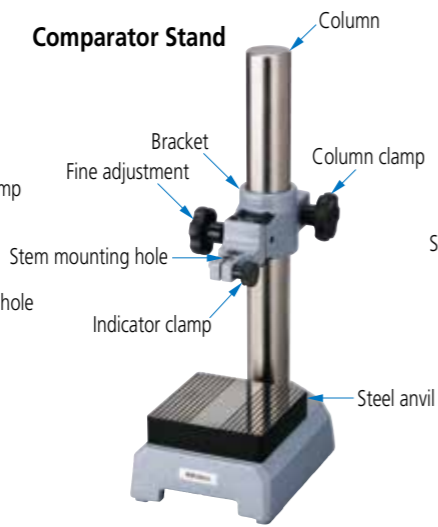
Photo 2

Transfer and Comparator Stands

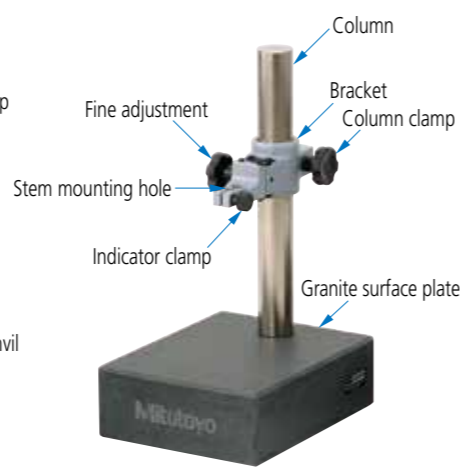
Dial Gage Stand



Comparator Stand



Granite Comparator Stand



Before Use

1. Clean the anvil or the granite surface using a dry cloth or a cloth moistened with alcohol.
2. Make sure to hold the bracket firmly when moving it up or down.
3. Mount the indicator in the stem mounting hole and tighten the clamp.
4. Move the bracket up and down all the way to ensure it moves smoothly.
5. To finely adjust the measuring position, use the fine feed knob.
6. After adjusting the measuring position, tighten the column clamp before starting measurement.
7. For the zero-point adjustment of the gage, it is recommended to use a gauge block or a master workpiece.

(Fig. 1)

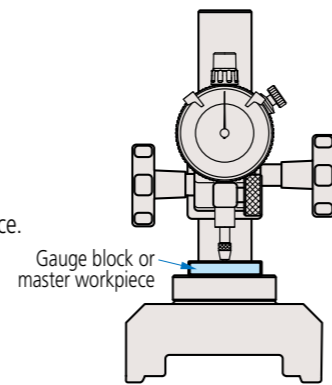


Fig. 1

During Use

1. Avoid repeatedly touching the anvil or the granite surface directly with the contact point, or dropping the contact point abruptly. (Fig. 2)
2. If a scratch is made on the anvil or the granite surface by any chance, remove any burrs with a lightly abrasive stone before continuing measurement.

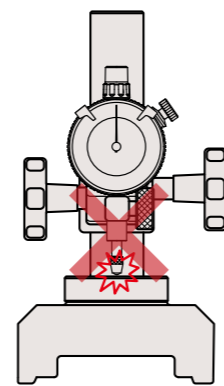


Fig. 2

If the instrument is damaged due to being dropped or struck hard, or for any other reason, do not use it and contact us for repair.

After Use

1. After using the instrument, check for damages on each part and use a dry cloth to clean.
2. Apply rust prevention treatment to the column and anvil without fail.
3. Store the instrument in a room free of excessive heat and moisture, also dust and oil mist.

Rectangular Gauge Blocks

Before Use

1. To obtain maximum benefit from the very high accuracy of gauge blocks, use them in a thermally stable environment. Apply compensation to measurements if the ambient temperature is significantly different from 20°C and the workpiece does not possess a similar coefficient of thermal expansion to the blocks.
2. Clean the measuring faces of all gauge blocks in use to prevent dust or dirt contamination affecting measurement results. (Cleaning paper : Order No.600006).
3. Check if there are burrs on the measuring faces using an optical flat (Order No.158-118). (Photo 1)
4. If burrs exist, remove them using Ceraston (Order No.601645) or an Arkansas stone (commercial product). (Photo 2)

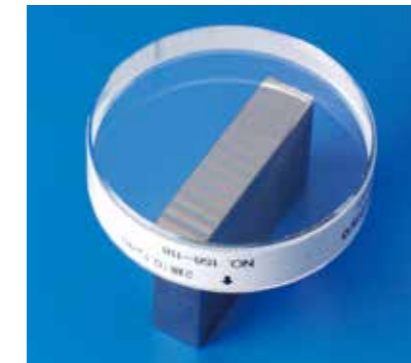


Photo 1

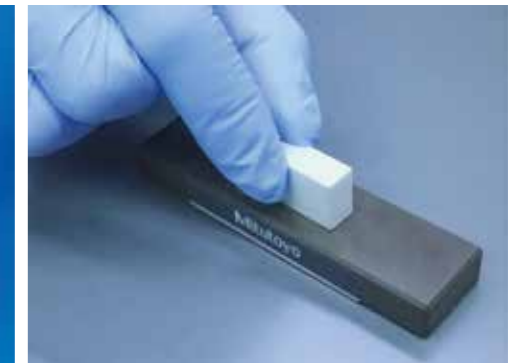


Photo 2

During Use

1. Handle gauge blocks with great care to avoid damage to the measuring surfaces due to impact with each other or by being dropped (Fig. 1). Damage, such as burrs, will adversely affect the accuracy of any measurements made.
2. To wring two gauge blocks together, apply thin grease or oil to the measuring surfaces and wipe off the excess leaving only a very thin layer adhering. Note that if there is insufficient oil or grease then wringing may be ineffective and block wear accelerated over time.

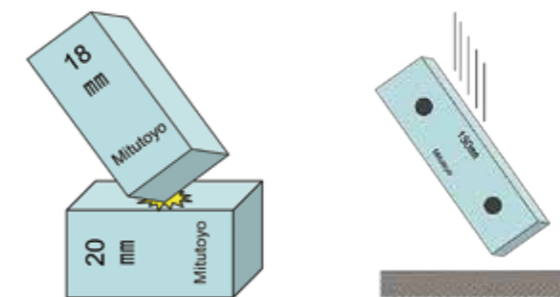


Fig. 1

After Use

1. Check for damage to the blocks and, if found, recondition them by the method described above.
2. After using steel gauge blocks, then clean and then apply rust prevention treatment using a cloth moistened with anti-corrosion oil.
3. A convenient kit (Order No. 516-650E, see page 27) is available for gauge block maintenance and cleaning before storage.
4. Store the instrument in a room free of excessive heat and moisture, also dust and oil mist.

Products Used for Maintenance of Measuring Instruments

Mitutoyo products

Micrometer oil

Lubrication and rust-prevention oil
Order No.207000*



207000
(Volume: 32ml)

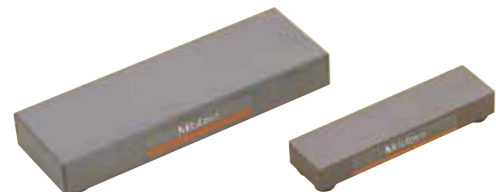
*Not available in certain countries and regions

Measuring face cleaning paper

Cleaning paper for micrometer measuring faces (1,000 sheets)
Order No.04AZB581

Ceraston

Ceraston is a very flat abrasive ceramic block used for removing burrs on hard, flat, precision surfaces.



Order No.601644
150 (W) x 50 (D) x 20 (H) mm

Order No.601645
100 (W) x 25 (D) x 12 (H) mm

Other products on the market (for reference)

Paper wipes KimWipes S-200

For removing contamination, such as dust, from instrument surfaces.



Contact: NIPPON PAPER CRECIA Co., LTD.

Maintenance kit for gauge blocks

Maintenance kit for gauge blocks includes all the necessary maintenance tools for removing burrs and contamination, and for applying anti-corrosion treatment after use, etc.



516-650E

Order No.516-650E

- Included items _____ Order No.
- (1) Ceraston (both sides finished by lapping) (100x25x12mm) ——— **601645**
 - (2) Optical flat **OF-45B** (ø45, thickness: 12mm, Flatness 0.2 μm) ——— **158-117**
Used to check the wringing of thin gauge blocks and for the presence of burrs.
 - (3) Tweezers ——— **600004**
Used for handling thin gauge blocks.
 - (4) Blower brush ——— **600005**
Used for blowing dust from measuring surfaces.
 - (5) Cleaning paper (lens paper) (82x304mm, 500 Sheets) ——— **600006**
Used for wiping off rust prevention oil and contamination. Lint free.
 - (6) Artificial leather mat (B4 size) ——— **600007**
Used as a gauge block mat in order to avoid scratches on the work table.
 - (7) Reagent bottle (polyethylene container, 100ml) ——— **600008**
Bottle of wiping solution.
(Mitutoyo employs n-Heptane for solvent.)
 - (8) Gloves ——— **600009**
Used for handling large gauge blocks. Effective for the prevention of corrosion and thermal expansion.

Mitutoyo Network

Download service at Mitutoyo website

Download of the brochure is available from the top page of Mitutoyo website by the following procedures:

If you are interested in any of our products listed in the General Catalog, please contact your local Mitutoyo sales office, or visit Mitutoyo local corporations website accessing from MITUTOYO Worldwide top page.

Also, the catalog can be downloaded in the PDF data (partially excluded) at our website. (See the above image.)

URL: <https://www.mitutoyo.co.jp/eng/>



Whatever your challenges are, Mitutoyo supports you from start to finish.

Mitutoyo is not only a manufacturer of top quality measuring products but one that also offers qualified support for the lifetime of the equipment, backed up by comprehensive services that ensure your staff can make the very best use of the investment.

Apart from the basics of calibration and repair, Mitutoyo offers product and metrology training, as well as IT support for the sophisticated software used in modern measuring technology. We can also design, build, test and deliver measuring solutions and even, if deemed cost-effective, take your critical measurement challenges in-house on a sub-contract basis.



Find additional product literature and our product catalogue

<https://www.mitutoyo.co.jp/global.html>

Our products are classified as regulated items under Japanese Foreign Exchange and Foreign Trade Law. Please consult us in advance if you wish to export our products to any other country. If the purchased product is exported, even though it is not a regulated item (Catch-All controls item), the customer service available for that product may be affected. If you have any questions, please consult your local Mitutoyo sales office.

Note: Product illustrations are without obligation. Product descriptions, in particular any and all technical specifications, are only binding when explicitly agreed upon. MITUTOYO and MICAT are either registered trademarks or trademarks of Mitutoyo Corp. in Japan and/or other countries/regions. Other product, company and brand names mentioned herein are for identification purposes only and may be the trademarks of their respective holders.

Mitutoyo

Mitutoyo Corporation

20-1, Sakado 1-Chome,
Takatsu-ku, Kawasaki-shi,
Kanagawa 213-8533, Japan
T +81 (0) 44 813-8230
F +81 (0) 44 813-8231
<https://www.mitutoyo.co.jp>