

Scale Units and Display Counters Linear Scale DRO Systems



Accurate, yet Affordable, DRO System from Mitutoyo

Mitutoyo's Linear Scale System tightly couples linear scale units with dedicated Digital Readout (DRO) units to offer accurate detection and display of axial displacement for machine tools and measuring equipment. The Linear Scale System can be configured to best meet your specific application, whether it be machining or measuring, just by choosing a suitable combination of scale unit and display unit. The Linear Scale System has superior ease-of-use and is reliable, both of which are features that can dramatically improve machining accuracy and efficiency.

Features of the Linear Scale System

1. Digital counter value display allows quick and accurate readout of displacement. Working efficiency thus greatly improved.
2. Zero-setting or presetting possible at any position. Versatile functions eliminate calculations or complicated key operations for positioning.
3. Various external output features allow output of current display values or various data to external devices such as PCs or sequencers. Easy data processing can be performed.

Detection principle of linear scales

OVERVIEW

- The assembly-type Linear Scale (AT) is a scale protected by a frame. Our product line-up now fully covers both incremental/absolute systems for table position control of machine tools.

FEATURES

1. Excellent environment resistance, vibration resistance and shock resistance.
2. Requires no signal adjustment and easy-to-install.
3. A high degree of freedom for detection head mounting.
4. Solid and simple structure.



Operating Principle of AT103/AT113 Models

The assembly-type Linear Scale® uses a highly accurate glass scale grating pitch of 20 μm as the basic standard of length. The grating is irradiated with parallel light generated with a Light-Emitting Diode (LED) and collimator lens. The parallel light transmitted through the grating generates an interference pattern with the same pitch as that of a grating on the photodiode array of the light-receiving device. The receiver output signal is 2-phase sinusoidal with a wavelength of 20 μm, identical to the pitch of the grating graduations, and is electrically converted to 2-phase square-wave signals by the interpolation circuit. The much smaller working resolution is achieved by detecting the cyclic variation in light intensity incident on the receiver array, as the scale is displaced in a measuring direction, and interpolating accordingly to output a corresponding displacement value.

Detecting Principle Added to AT715

The Absolute system-type linear scale AT715 employs a unique, Mitutoyo-proprietary, electromagnetic induction principle that is highly resistant to environmental contamination. Achievement of a true absolute scale with a resolution of 1 μm, thanks to a multi-track configuration, enables the user to obtain absolute positional information from the scale immediately power is applied to the counter.

Basic principle of electromagnetic induction type sensor

- If time-varying current I_1 is applied to coil A, a magnetic flux is generated inside the coil.
- A current I_2 is induced in coil B that tends to oppose the build-up of the magnetic flux.

The magnetic permeability between the coils will not vary whether the medium is air, water, or oil.

The electromagnetic induction type sensor has excellent water resistance and oil resistance.

Operating Principle of Electromagnetic Induction Type Encoder

The absolute encoder is comprised of multi-track components. Multiple coils are arranged on the scale at a constant pitch.

Note 1: Export to EU Member Countries

When you intend to export this product to any of the EU member countries, you may be required to provide User's Manual(s) in English and the EU Declaration of Conformity in English (under certain circumstances, User's Manual(s) in the destination country's official language and the EU Declaration of Conformity in the destination country's official language). For detailed information, please contact Mitutoyo in advance.

Note 2: The WEEE Directive

The WEEE Directive*1 is a directive that mandates appropriate collection and recycling of electrical and electronic equipment waste. The purpose of this directive is to increase the reuse and recycling of these products, and seeks eco-friendly product design. To differentiate between equipment waste and household waste, a crossed-out wheeled-bin symbol is marked on a product. We will promote eco-friendly design for our products.

*1 WEEE Directive: Directive 2012/19/EU of the European Parliament and of the Council on waste electrical and electronic equipment.

Mitutoyo Linear Scales are traceable to the national standard

Traceability of Mitutoyo Reference Standards

Mitutoyo ensures and maintains traceability of various types of precision measuring instruments by holding standards of length and other physical quantities that are directly traceable to the national standards for use in calibrating the working standards used for the calibration of measuring instrument products supplied to industry.

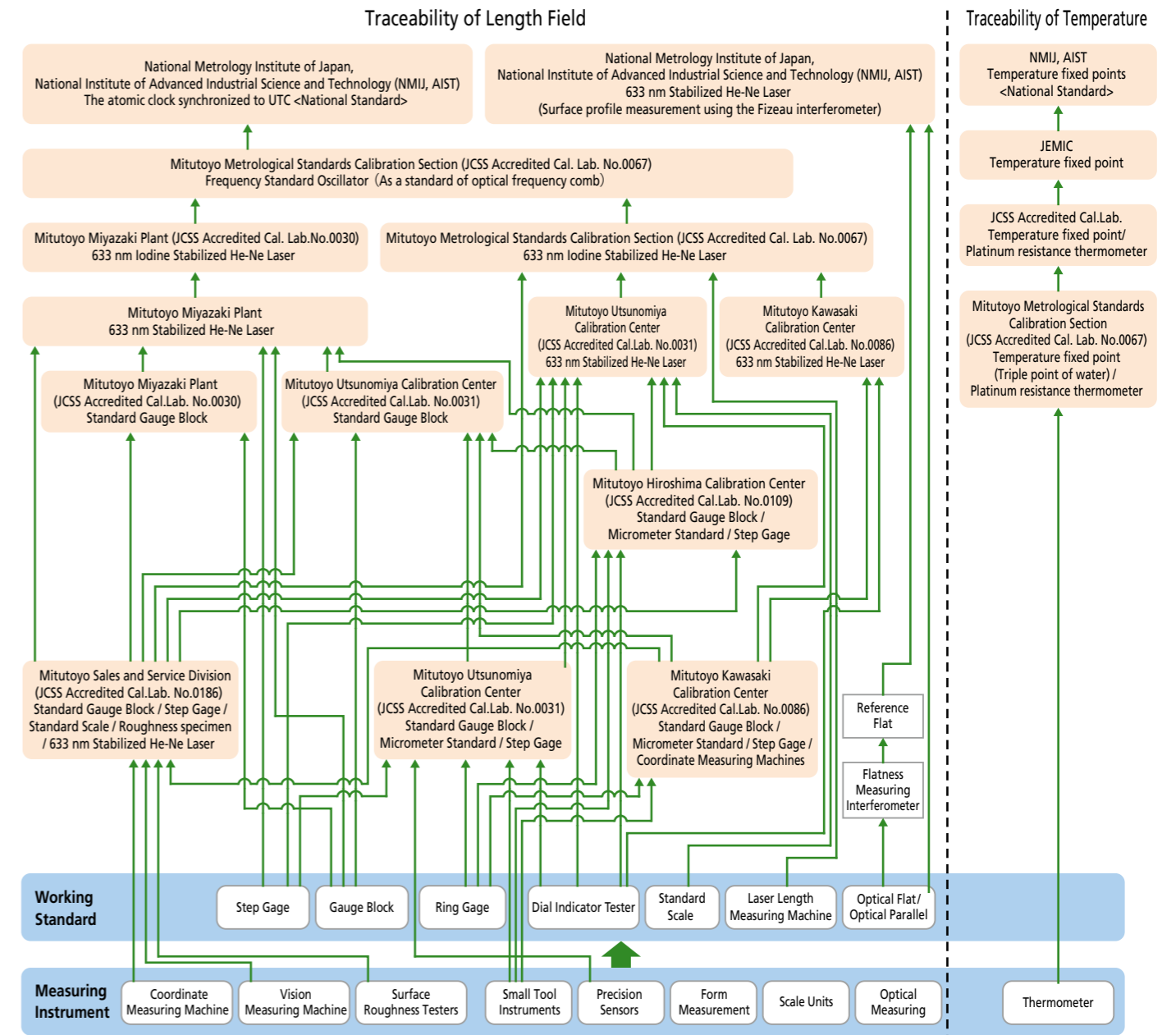

◆ This chart shows a simplified traceability system of a part of Mitutoyo products. Detailed traceability charts are published for each product. (As of January, 2024)

For the latest information, please refer to our website. <https://www.mitutoyo.co.jp>

Linear Scale Unit

Model	AT715 ABSOLUTE and High Environmental Resistance Type	AT103 Standard-size Type	AT113 Slim Type
Sectional dimensions			
Measurement method	Electromagnetic induction system	Photoelectric: Transparent linear encoder Light source: LED Receptor: Phototransistor	
Output wave form	—	2-phase sine curves with a phase difference of 90°	
Effective range*2	100 - 3000 mm	100 - 6000 mm	100 - 1500 mm
Accuracy (20 °C)*3	± 5 μm (100 to 500 mm*) ± 7 μm (600 to 1800 mm*) ± 10 μm (2000 to 3000 mm*) *effective measurement length	AT103, AT113: (5+5L _e /1000) μm L _e : Effective range High-accuracy type** is (3+3L _e /1000) μm Super high-accuracy type** is (2+2L _e /1000) μm	
Maximum response speed	50 m/min	120 m/min**6	
Scale reference point	—	At every 50 mm interval	
Linear expansion coefficient	—	(8 ± 1) × 10 ⁻⁵ /K	
Power supply	5 VDC ± 5 %	5 VDC ± 5 %	
Max. current consumption	70 mA	70 mA	60 mA
Operating/Storage temperature	0 to 45 °C/-20 to 70 °C		
Operating/Storage temperature (relative humidity)	0 to 50 °C/-20 to 70 °C	0 to 45 °C/-20 to 70 °C	
Head cable length	—	—	0.3 m
Dust/water protection level	IP67	—	
Sliding force	5 N or less	5 N or less	
Signal cable*7	Standard accessory (refer to individual specifications for the length)		
Extension cable*8 (optional) (Conduit type)	Length	Code No.	Code No.
	2 m	09AAB674A	09AAA033A
	5 m	09AAB674B	09AAA033B
	7 m	09AAB674C	09AAA033C

- *1: 37.5 × 95.5 mm for the AT103-3250 or larger models.
- *2: Make sure that the linear scale's maximum travel distance (L1) is greater than the maximum travel distance of the machine when selecting a linear scale size. Also, since the assured accuracy is limited within the effective range (L_e), select a linear scale size with this in mind.
- *3: (5+8L_e/1000) μm for the AT103-3250 or larger models.
- *4: It is possible to manufacture 100 - 2000 mm for type F of the AT103; 100 - 1500 mm for type F of the AT113.
- *5: It is possible to manufacture 100 - 500 mm for type S of the AT113.
- *6: 50 m/min for the AT103-3250 or larger models.
- *7: Vinyl-coated type signal cable and extension cable are available on request.
- *8: The maximum extension length of AT715 is 15 m in total.

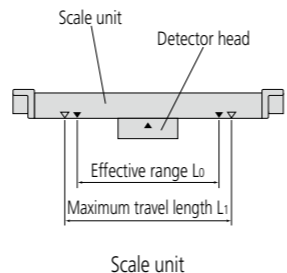

ABSOLUTE and High Environmental Resistance Type Scale Unit

AT715 Absolute scale unit with excellent resistance to harsh environments

Reference dimensions for mounting

Effective range 100 - 3000 mm



ABSOLUTE™ IP67

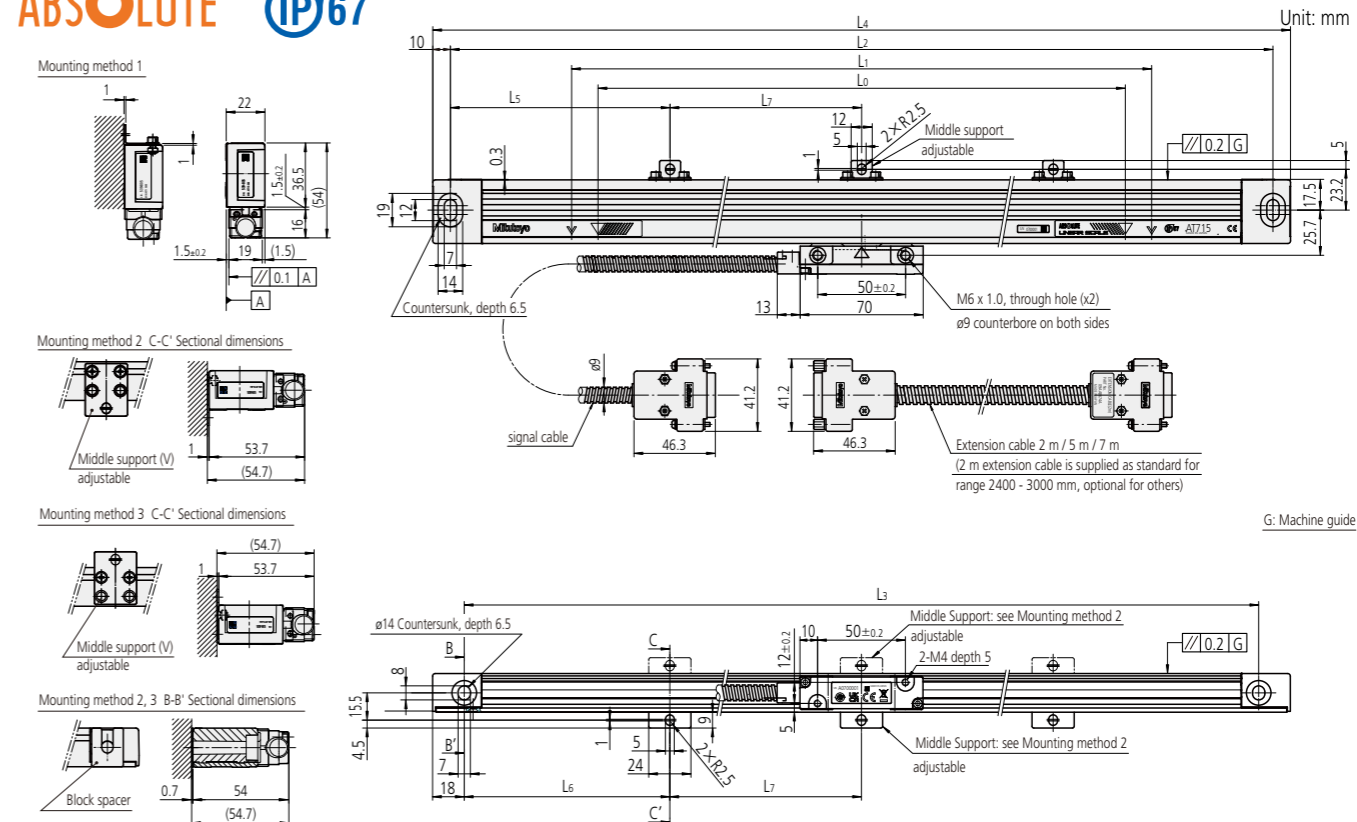

G: Machine guide

AT715		Effective range L _e (mm)	Maximum travel length L ₁ (mm)	Mounting hole pitch L ₁ (mm)	Mounting hole pitch L ₂ (mm)	Overall length L ₀ (mm)	Middle support positions L ₁ (mm)	Middle support positions L ₂ (mm)	Middle support positions L ₃ (mm)	Signal cable length (m)
Code No.	Model									
539-801N	AT715-100	100 (4 in)	120 (4.72 in)	258 (10.16 in)	242 (9.53 in)	278 (10.94 in)				3.5
539-802N	AT715-150	150 (6 in)	170 (6.69 in)	308 (12.13 in)	292 (11.50 in)	328 (12.91 in)				
539-803N	AT715-200	200 (8 in)	220 (8.66 in)	358 (14.09 in)	342 (13.46 in)	378 (14.88 in)				
539-804N	AT715-250	250 (10 in)	270 (10.63 in)	408 (16.06 in)	392 (15.43 in)	428 (16.85 in)				
539-805N	AT715-300	300 (12 in)	330 (12.99 in)	468 (18.43 in)	452 (17.80 in)	488 (19.21 in)				
539-806N	AT715-350	350 (14 in)	380 (14.96 in)	518 (20.39 in)	502 (19.76 in)	538 (21.18 in)				
539-807N	AT715-400	400 (16 in)	430 (16.93 in)	568 (22.36 in)	552 (21.73 in)	588 (23.15 in)				
539-808N	AT715-450	450 (18 in)	480 (18.90 in)	618 (24.33 in)	602 (23.70 in)	638 (25.12 in)				
539-809N	AT715-500	500 (20 in)	540 (21.26 in)	678 (26.69 in)	662 (26.06 in)	698 (27.48 in)	339 (13.35 in)	331 (13.03 in)		
539-811N	AT715-600	600 (24 in)	640 (25.20 in)	778 (30.63 in)	762 (30.00 in)	798 (31.42 in)	389 (15.31 in)	381 (15.00 in)		
539-813N	AT715-700	700 (28 in)	740 (29.13 in)	878 (34.57 in)	862 (33.94 in)	898 (35.35 in)	439 (17.28 in)	431 (16.97 in)		
539-814N	AT715-750	750 (30 in)	780 (30.71 in)	918 (36.14 in)	902 (35.51 in)	938 (36.93 in)	459 (18.07 in)	451 (17.76 in)		
539-815N	AT715-800	800 (32 in)	840 (33.07 in)	978 (38.50 in)	962 (37.87 in)	998 (39.29 in)	489 (19.25 in)	481 (18.94 in)		
539-816N	AT715-900	900 (36 in)	940 (37.01 in)	1078 (42.44 in)	1062 (41.81 in)	1098 (43.23 in)	539 (21.22 in)	531 (20.91 in)		
539-817N	AT715-1000	1000 (40 in)	1040 (40.94 in)	1178 (46.38 in)	1162 (45.75 in)	1198 (47.17 in)	589 (23.19 in)	581 (22.87 in)		
539-818N	AT715-1100	1100 (44 in)	1140 (44.88 in)	1278 (50.31 in)	1262 (49.69 in)	1298 (51.10 in)	624 (24.57 in)	616 (24.26 in)	430 (16.93 in)	
539-819N	AT715-1200	1200 (48 in)	1240 (48.82 in)	1378 (54.25 in)	1362 (53.62 in)	1398 (55.04 in)	659 (26.00 in)	651 (25.63 in)	460 (18.11 in)	
539-820N	AT715-1300	1300 (52 in)	1340 (52.76 in)	1478 (58.19 in)	1462 (57.56 in)	1498 (58.98 in)	694 (27.40 in)	686 (27.01 in)	490 (19.29 in)	
539-821N	AT715-1400	1400 (56 in)	1440 (56.69 in)	1578 (62.13 in)	1562 (61.50 in)	1598 (62.91 in)	724 (28.50 in)	716 (28.17 in)	520 (20.47 in)	
539-822N	AT715-1500	1500 (60 in)	1540 (60.63 in)	1678 (66.06 in)	1662 (65.43 in)	1698 (66.85 in)	759 (30.00 in)	751 (29.57 in)	550 (21.65 in)	
539-823N	AT715-1600	1600 (64 in)	1640 (64.57 in)	1778 (70.00 in)	1762 (69.37 in)	1798 (70.79 in)	789 (31.06 in)	781 (30.75 in)	580 (22.83 in)	
539-824N	AT715-1700	1700 (68 in)	1740 (68.50 in)	1878 (73.94 in)	1862 (73.31 in)	1898 (74.72 in)	819 (32.24 in)	811 (31.93 in)	610 (24.01 in)	
539-825N	AT715-1800	1800 (72 in)	1840 (72.44 in)	1978 (77.87 in)	1962 (77.24 in)	1998 (78.66 in)	849 (33.42 in)	841 (33.12 in)	640 (25.19 in)	
539-860N	AT715-2000	2000 (80 in)	2040 (80.31 in)	2178 (85.75 in)	2162 (85.12 in)	2198 (86.54 in)	929 (36.57 in)	921 (36.26 in)	710 (27.95 in)	
539-861N	AT715-2200	2200 (88 in)	2240 (88.19 in)	2378 (93.62 in)	2362 (92.99 in)	2398 (94.41 in)	1009 (39.72 in)	1001 (39.41 in)	780 (30.71 in)	
539-862N	AT715-2400	2400 (96 in)	2440 (96.06 in)	2578 (101.50 in)	2562 (100.87 in)	2598 (102.28 in)	1089 (42.87 in)	1081 (42.56 in)	850 (33.46 in)	
539-863N	AT715-2500	2500 (100 in)	2540 (100.00 in)	2678 (105.43 in)	2662 (104.80 in)	2698 (106.22 in)	1119 (44.05 in)	1111 (43.74 in)	880 (34.63 in)	
539-864N	AT715-2600	2600 (104 in)	2640 (103.94 in)	2778 (109.37 in)	2762 (108.74 in)	2798 (110.16 in)	1149 (45.23 in)	1141 (45.31 in)	910 (35.81 in)	
539-865N	AT715-2800	2800 (112 in)	2840 (111.81 in)	2978 (117.24 in)	2962 (116.61 in)	2998 (118.03 in)	1229 (48.35 in)	1221 (48.04 in)	980 (38.58 in)	
539-866N	AT715-3000	3000 (120 in)	3040 (119.68 in)	3178 (125.12 in)	3162 (124.49 in)	3198 (125.91 in)	1309 (51.53 in)	1301 (51.22 in)	1050 (41.34 in)	

* Combination of a 5 m signal cable and a 2 m extension cable

Standard-size Type Scale Unit

AT103 Standard type with wide measuring range



Reference dimensions for mounting

Effective range 1600 – 3000 mm

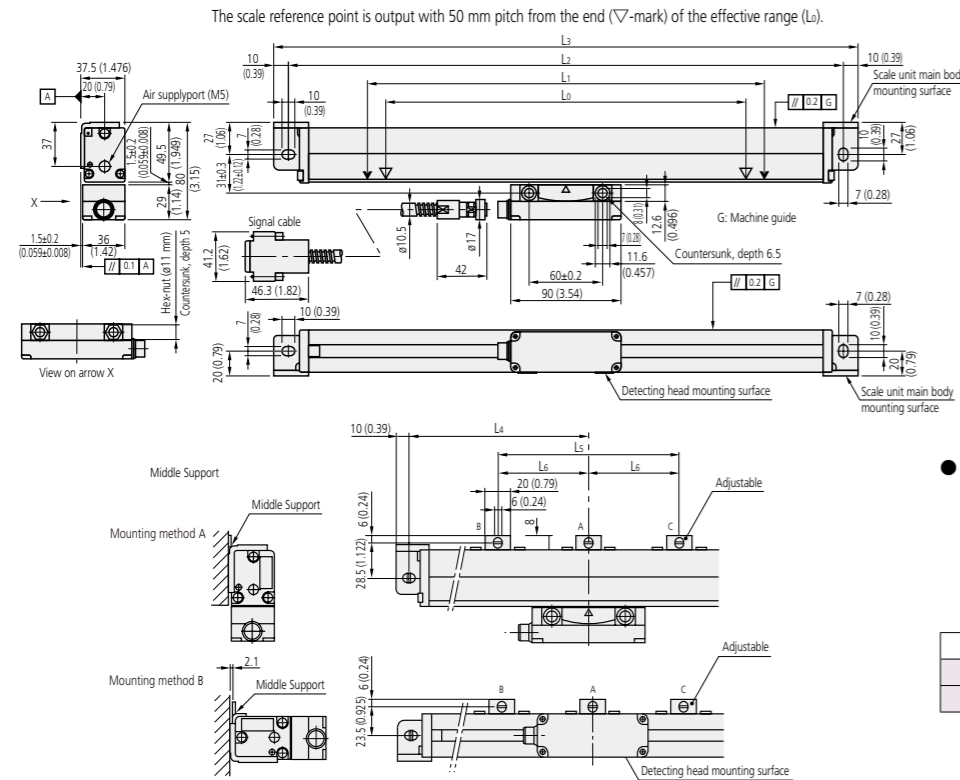

mm (inch)

● Dimensions L4, L5 and L6 indicate the recommended positions of intermediate supports for scale units. (The intermediate support position is adjustable in the measuring length direction.)

Effective range (mm)	Middle Support
1600 – 2200	B C (2 points)
2400 – 3000	A B C (3 points)

AT103		Effective range L ₀ (mm)	Maximum travel length L ₁ (mm)	Mounting hole pitch L ₂ (mm)	Overall length L ₃ (mm)	Middle support positions L ₄ (mm)	Middle support positions L ₅ (mm)	Middle support positions L ₆ (mm)	Signal cable length (m)
Code No.	Model								
539-133-30	AT103-1600	1600 (64 in)	1690 (66.53 in)	1818 (71.57 in)	1838 (72.36 in)	—	—	—	5
539-134-30	AT103-1700	1700 (68 in)	1790 (70.47 in)	1918 (75.51 in)	1938 (76.30 in)				
539-135-30	AT103-1800	1800 (72 in)	1890 (74.41 in)	2018 (79.45 in)	2038 (80.24 in)				
539-136-30	AT103-2000	2000 (80 in)	2100 (82.67 in)	2228 (87.72 in)	2248 (88.50 in)				
539-137-30	AT103-2200	2200 (88 in)	2300 (90.55 in)	2428 (95.59 in)	2448 (96.38 in)				
539-138-30	AT103-2400	2400 (96 in)	2500 (98.42 in)	2628 (103.46 in)	2648 (104.25 in)	1314 (51.73 in)	1300 (51.18 in)	650 (25.59 in)	7
539-139-30	AT103-2500	2500 (100 in)	2600 (102.36 in)	2728 (107.40 in)	2748 (108.19 in)	1364 (53.70 in)	1340 (52.76 in)	670 (25.38 in)	
539-140-30	AT103-2600	2600 (104 in)	2700 (106.30 in)	2828 (111.34 in)	2848 (112.13 in)	1414 (55.67 in)	1400 (55.12 in)	700 (27.56 in)	
539-141-30	AT103-2800	2800 (112 in)	2900 (114.17 in)	3028 (119.21 in)	3048 (120.00 in)	1514 (59.60 in)	1500 (59.06 in)	750 (29.53 in)	
539-142-30	AT103-3000	3000 (120 in)	3100 (118.11 in)	3228 (127.09 in)	3248 (127.87 in)	1614 (63.99 in)	1600 (62.99 in)	800 (31.50 in)	

Note 1: High precision model AT103F (JIS Class 0, (3+3L/1000) μm) is also available to special order for the effective range of 1600 to 2000 mm.
 Note 2: The indication accuracy does not include quantizing error. L₀: Effective range (mm)

Standard-size Type Scale Unit

AT103 Standard type with wide measuring range



Reference dimensions for mounting

Effective range 3250 – 6000 mm

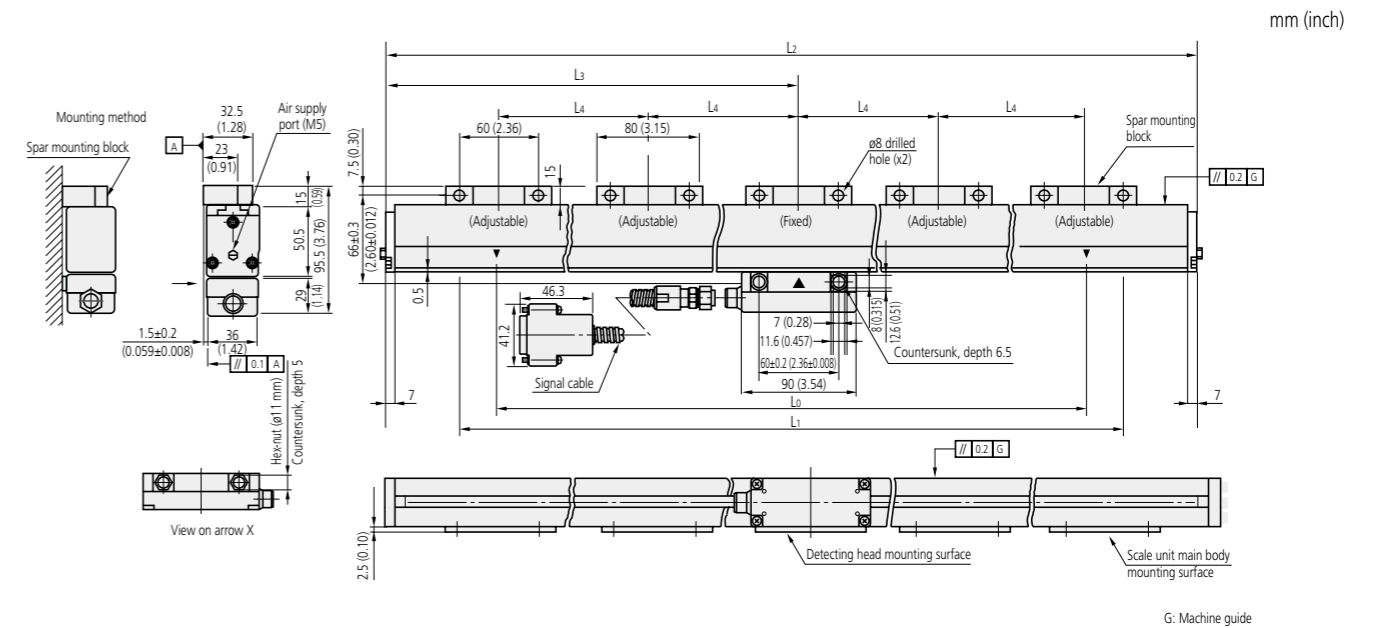

mm (inch)

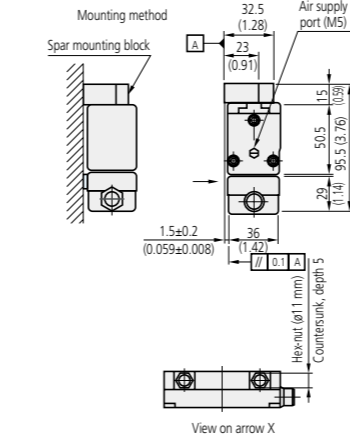

View on arrow X

AT103		Effective range L ₀ (mm)	Maximum travel length L ₁ (mm)	Overall length L ₂ (mm)	Supporting bracket position L ₃ (mm)	Supporting bracket position L ₄ (mm)	Signal cable length (m)
Code No.	Model						
539-143-30	AT103-3250	3250 (130 in)	3350 (131.88 in)	3464 (136.38 in)	1725 (67.91 in)	800 (31.50 in)	10
539-144-30	AT103-3500	3500 (140 in)	3600 (141.73 in)	3714 (146.22 in)	1850 (72.83 in)	850 (33.46 in)	
539-145-30	AT103-3750	3750 (150 in)	3850 (151.57 in)	3964 (156.06 in)	1975 (77.76 in)	930 (36.61 in)	
539-146-30	AT103-4000	4000 (160 in)	4100 (161.42 in)	4214 (165.91 in)	2100 (82.68 in)	1000 (39.37 in)	
539-147-30	AT103-4250	4250 (170 in)	4350 (171.26 in)	4464 (175.75 in)	2225 (87.60 in)	1050 (41.34 in)	
539-148-30	AT103-4500	4500 (180 in)	4600 (181.10 in)	4714 (185.59 in)	2350 (92.52 in)	1100 (43.31 in)	
539-149-30	AT103-4750	4750 (190 in)	4850 (191.94 in)	4964 (195.43 in)	2475 (97.44 in)	800 (31.50 in)	
539-150-30	AT103-5000	5000 (200 in)	5100 (200.78 in)	5214 (205.28 in)	2600 (102.36 in)	830 (32.68 in)	15
539-151-30	AT103-5250	5250 (210 in)	5350 (210.63 in)	5464 (215.12 in)	2725 (107.28 in)	870 (34.25 in)	
539-152-30	AT103-5500	5500 (220 in)	5600 (220.47 in)	5714 (224.96 in)	2850 (112.20 in)	910 (35.83 in)	
539-153-30	AT103-5750	5750 (230 in)	5850 (230.31 in)	5964 (234.80 in)	2975 (117.13 in)	950 (37.40 in)	
539-154-30	AT103-6000	6000 (240 in)	6100 (240.16 in)	6214 (244.65 in)	3100 (122.05 in)	1000 (39.37 in)	

G: Machine guide

Slim Type Scale Unit

AT113 Slim type with cross-sectional dimensions of 22 x 35 mm

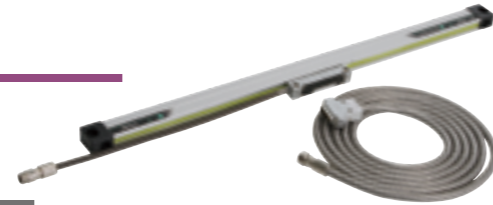

Reference dimensions for mounting

Effective range 100 – 1500 mm

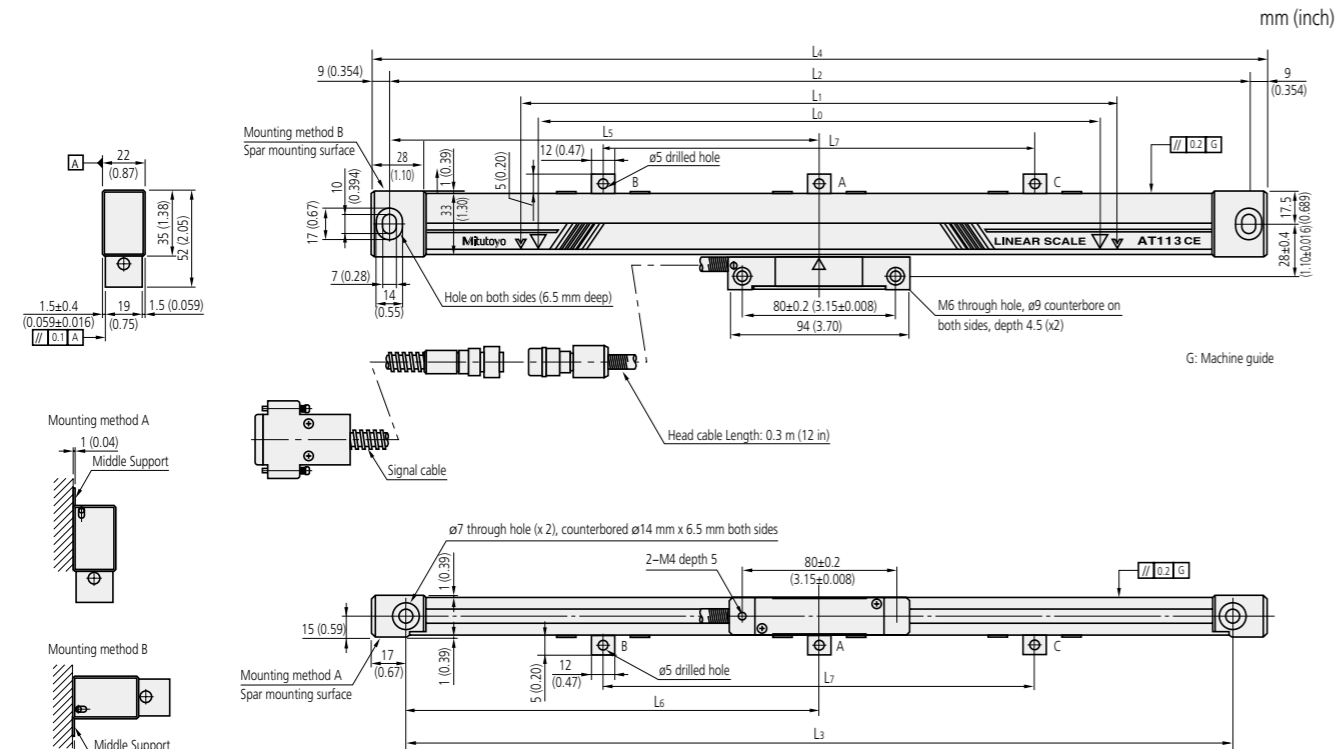

● Dimensions L5, L6 and L7 indicate the recommended positions of intermediate supports for scale units with an effective range greater than 500 mm.

Effective range (mm)	Middle Support
500 – 1000	A (1 point)
1100 – 1500	B C (2 points)

AT113		Effective range L _e (mm)	Maximum travel length L _t (mm)	Mounting hole pitch L ₁ (mm)	Mounting hole pitch L ₂ (mm)	Overall length L _t (mm)	Middle support positions L ₅ (mm)	Middle support positions L ₆ (mm)	Middle support positions L ₇ (mm)	Signal cable length (m)
Code No.	Model									
539-201-30	AT113-100	100 (4 in)	120 (4.72 in)	258 (10.16 in)	242 (9.53 in)	276 (10.87 in)				3
539-202-30	AT113-150	150 (6 in)	170 (6.69 in)	308 (12.13 in)	292 (11.50 in)	326 (12.83 in)				
539-203-30	AT113-200	200 (8 in)	220 (8.66 in)	358 (14.09 in)	342 (13.46 in)	376 (14.80 in)				
539-204-30	AT113-250	250 (10 in)	270 (10.63 in)	408 (16.06 in)	392 (15.43 in)	426 (16.77 in)				
539-205-30	AT113-300	300 (12 in)	330 (12.99 in)	468 (18.43 in)	452 (17.80 in)	486 (19.13 in)				
539-206-30	AT113-350	350 (14 in)	380 (14.96 in)	518 (20.39 in)	502 (19.76 in)	536 (21.10 in)				
539-207-30	AT113-400	400 (16 in)	430 (16.93 in)	568 (22.36 in)	552 (21.73 in)	586 (23.07 in)				
539-208-30	AT113-450	450 (18 in)	480 (18.90 in)	618 (24.33 in)	602 (23.70 in)	636 (25.04 in)				
539-209-30	AT113-500	500 (20 in)	540 (21.26 in)	678 (26.69 in)	662 (26.06 in)	696 (27.40 in)	339 (13.35 in)	331 (13.03 in)		
539-211-30	AT113-600	600 (24 in)	640 (25.20 in)	778 (30.63 in)	762 (30.00 in)	796 (31.34 in)	389 (15.31 in)	381 (15.00 in)		
539-213-30	AT113-700	700 (28 in)	740 (29.13 in)	878 (34.57 in)	862 (33.94 in)	896 (35.28 in)	439 (17.28 in)	431 (16.97 in)		
539-214-30	AT113-750	750 (30 in)	780 (30.71 in)	918 (36.14 in)	902 (35.51 in)	936 (36.85 in)	459 (18.07 in)	451 (17.76 in)		
539-215-30	AT113-800	800 (32 in)	840 (33.07 in)	978 (38.50 in)	962 (37.87 in)	996 (39.21 in)	489 (19.25 in)	481 (18.94 in)		
539-216-30	AT113-900	900 (36 in)	940 (37.01 in)	1078 (42.44 in)	1062 (41.81 in)	1096 (43.15 in)	539 (21.22 in)	531 (20.91 in)		
539-217-30	AT113-1000	1000 (40 in)	1040 (40.94 in)	1178 (46.38 in)	1162 (45.75 in)	1196 (47.09 in)	589 (23.19 in)	581 (22.87 in)		
539-218-30	AT113-1100	1100 (44 in)	1140 (44.88 in)	1278 (50.31 in)	1262 (49.69 in)	1296 (51.02 in)			430 (16.93 in)	5
539-219-30	AT113-1200	1200 (48 in)	1240 (48.82 in)	1378 (54.25 in)	1362 (53.62 in)	1396 (54.96 in)			460 (18.11 in)	
539-220-30	AT113-1300	1300 (52 in)	1340 (52.76 in)	1478 (58.19 in)	1462 (57.56 in)	1496 (58.90 in)			490 (19.29 in)	
539-221-30	AT113-1400	1400 (56 in)	1440 (56.69 in)	1578 (62.13 in)	1562 (61.50 in)	1596 (62.83 in)			530 (20.87 in)	
539-222-30	AT113-1500	1500 (60 in)	1540 (60.63 in)	1678 (66.06 in)	1662 (65.43 in)	1696 (66.77 in)			560 (22.05 in)	

Note 1: High precision model **AT113F** (JIS Class 0, 3+3L/1000) μm is also available to special order.
 Note 2: Ultra-high precision model **AT113S** (2+2L/1000) μm is also available to special order for the effective range 100 to 500 mm.
 Note 3: The indication accuracy does not include quantizing error. L_e: Effective range (mm)

Display Unit (counter)

Type	High performance
Function	KA-200 Counter
Zero-setting	ZERO ●
Preset	P.SET ●
Resolution setting	0.0005 / 0.1 ●
Measurement direction setting	← ●
mm/inch conversion	mm / E ●
Diameter display	DIA ●
Scale reference point setting*1	▼ SET ●
1/2 calculation	1/2 ●
Coordinate system switching	N ●
Bolt-hole circle machining	⊕ ●*2
Pitch machining	↗ ●
Zero approach machining (INC mode)	⊕-1 ●
Addition of 2-scale data	Z1+Z2 ●*3
Linearity error compensation	↔ ●
Pitch error compensation	↗ ●*1
Smoothing	1234 ●
Memory backup	🔋 ●
Scaling ratio	📏 ●
Lower digit blanking out	123 ●
External zero-setting	ZERO SET IN PUT ▲*4
RS-232C interface unit	RS-232C OUTPUT ▲*4
USB output	USB ▲*5
Error message	Error ●

●: Standard function, ▲: Optional function, —: Not available
 *1: Only available when connecting with AT100 Series.
 *2: Not available in single-axis use
 *3: Only available for 3-axis model (KA-213)
 *4: Code out unit (06AET993) is required.
 *5: Data output via optional code out unit and foot switch (937179T)

Display Unit (counter)

KA-200 Counter

High performance display unit with many functions.

FEATURES

- Can be used as a “standard counter” or “lathe counter” by modifying parameters.
- Downsizing, weight saving and multiple functionality have been realized.
- Sub display for easy operation.
- The optional external interface RS-232C enables connection to a PC and printer.
- Text data can be output using the optional USB interface.
- Two-year guarantee



KA-212



KA-213

DIMENSIONS

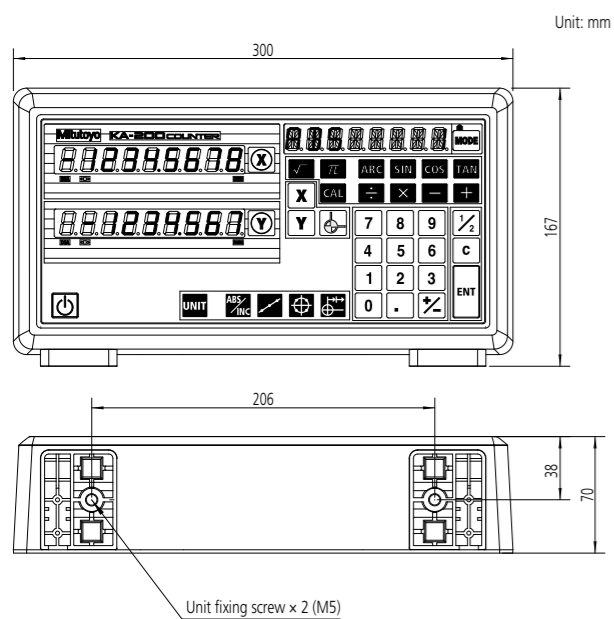

SPECIFICATIONS

Code No.	174-183□	174-185□
Model	KA-212	KA-213
Number of axes displayed	2	3
Resolution	(Changeable according to the parameter) When AT100 is connected: 0.05 to 0.0001 mm When AT715 is connected: 0.01 to 0.001 mm	
Display/digit	Main display: 9 digits including sign Sub display: 8 digits	
Power supply voltage	100-240 VAC, 50/60 Hz	
Power consumption	20-25 VA	
Operating temperature/humidity range	0 to 45 °C, RH 20 to 80%	
Storage temperature/humidity range	-10 to 60 °C, RH 20 to 80%	
Dimensions	300 (W) × 70 (D) × 167 (H) mm	
Output (optional)	RS-232C	
Mass	1.25 kg	1.3 kg

□: To denote the power cable for your Country/region add the applicable suffix to the code of the counter. Examples are provided below.

Standard Accessories

1.8 m AC cable (provided with counter. Please see the below table for the combination)

Code No. and Suffix for counter	Country/Region*	Power supply standard	Code No. for AC cable
174-183/174-185	Japan	PSE	02ZAA000
174-183A/174-185A	America, Canada	UL CSA	02ZAA010
174-183B/174-185B	Asia	PSE	02ZAA000
174-183D/174-185D	Europe	CEE	02ZAA020
174-183E/174-185E	UK	BS	02ZAA030
174-183F/174-185F	Australia	AS	933098
174-183DC/174-185DC	China	CCC	02ZAA040
174-183KC/174-185KC	Korea	EK	02ZAA050

Note: Please also confirm the power supply standard

- Dust-proof cover: **06AEU075**
- GND lead wire (4 m): **09CAA985**
- Seal set (1 pc.): **06AEU080**
- D-SUB15P Connector cap: **06AFC149**
- User's Manual (1 set): **99MBE083A**

Optional Accessories

- Code out unit: **06AET993**
- External extension cable: **06ACF941**
- Foot switch for measurement data output (USB interface): **937179T**

Note: The touch-probe has been discontinued.

Part names

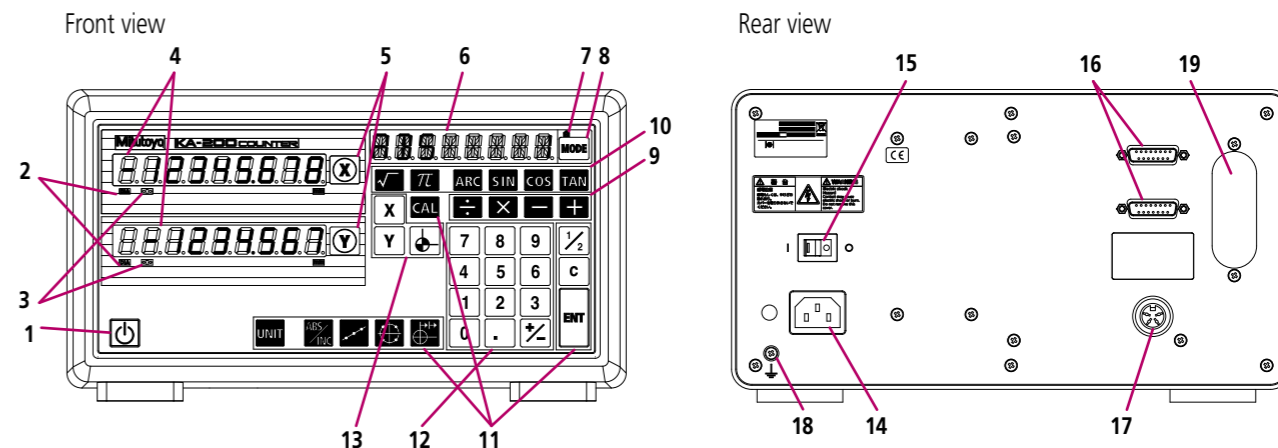

1. Display ON/OFF switch

Turns ON/OFF the display on the front panel.

2. DIA

Lights up while the diameter is displayed.

3. Scaling

Lights up when a scaling ratio is applied.

4. Main display

Displays each axis count value with 1-digit sign and 8-digit numbers.

5. Zero reset key

Resets the display of each axis to zero.

6. Sub-display

Displays set coordinates and operation information.

7. Lock

Lights up when a function is locked.

8. MODE key

Keys to execute functions used with numeric keys.

9. Four arithmetic operation keys

Keys to execute arithmetic operations.

10. Trigonometric function keys

Keys to execute trigonometric operations.

11. Function keys

Keys for controlling the basic functions.

12. Numeric keypad

Keys for entering numerical data.

13. Axis/coordinates selection key

Keys for selecting axis or coordinates.

14. AC inlet

Connects the power cord.

15. Main switch

Turns the power ON/OFF as the main switch.

16. Linear scale input connectors

Connects scale units.

17. Touch signal probe connector

Connects the touch signal probe.

18. Ground terminal

Terminal for connecting the earth lead for grounding the main unit.

19. Interface unit fixing section

Connects an optional code out unit.

Display Unit (counter)

Basic functions

Zero-setting ZERO

The display can be set to "0" (zero) at any scale position.

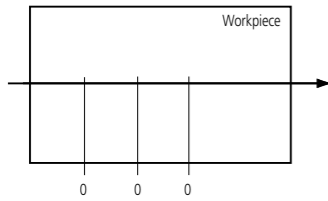

Lower digit blanking out 123

Unnecessary lower digits (up to 4 digits of the lowest digits) can be blanked out.

Resolution setting 0.0005 / 0.1

The display resolution can be selected from among 0.05, 0.01, 0.005, 0.002, 0.001, 0.0005 and 0.0001 mm. (When AT100 Series is connected.)
When the AT715 is connected, the display resolution can be selected from among 0.01, 0.005, 0.002 and 0.001 mm.

Preset P.SET

This function allows the user to enter a numeric value on the counter display.

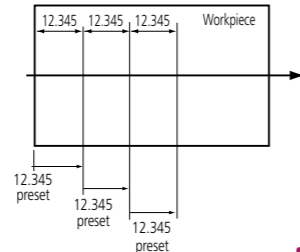

1/2 calculation 1/2

This function halves the display value.

Absolute/incremental coordinate system switching KA-200 Counter

Although both the scale and the counter use the incremental system, detecting the origin point on the scale enables using them as absolute coordinates.

Thus two coordinate systems are available:

- Absolute coordinate system
When measuring by defining an arbitrary coordinate point as a reference, setting the machine origin to 0 is convenient. This coordinate system is also usable when an arbitrary workpiece point is set as a reference point, and setting a datum point on the workpiece to 0 is convenient in this case.
- Incremental coordinate system
Use this system when successively measuring with an arbitrary point as a reference point. In this case, performing zero-setting each time when reaching an arbitrary point is convenient.

Measurement direction setting

The readout can be set to count up or down in either direction of scale movement, whichever is more convenient for the operator.

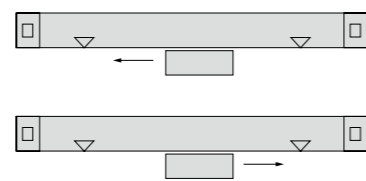

mm/inch conversion mm/E

The counting unit can be changed between "mm" and "inch" (or between "mm" and "E (=1/25.4 mm)" depending on the model.)

Special functions

Linearity error compensation

Machine errors caused due to workpiece weight, inaccurate table adjustment, etc., are linearly compensated to reduce the positioning error.

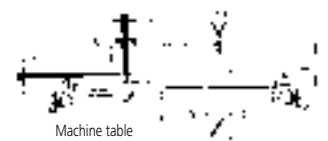

Display value backup

The displayed value at power-off is preserved in memory and restored at the next power-on. When an AT715 scale is connected to the counter, the stored display value is corrected appropriately if the detector head is moved during power off so that the display always shows the correct displacement from the origin.

Smoothing Function 1234

Turning on 'smoothing' slows display updating to enable the display to be read more easily when a measurement value is rapidly oscillating due to machine vibration. Measurement speed remains unaffected.

Expansion/contraction coefficient setting

This function multiplies the actual counter measurements by a constant factor. This is useful in, for example, mold manufacture by allowing the mold to be machined to the actual molded component dimensions directly, without having to increase the machining dimensions manually to allow for material shrinkage after molding. Tedious work can thus be reduced and the risk of mistakes in calculation eliminated.

Parameter All Clear A CLR

Clears the setup parameter data and resets to the default data.

Pitch Error Correction KA-200 Counter & AT100 Series

This function allows correction of machine errors, thus improving positioning accuracy.

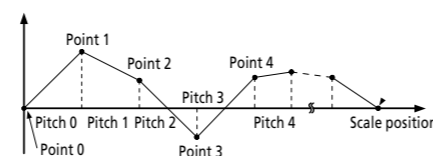

Function Lock KA-200 Counter

This function prevents any risk of the operational settings being accidentally changed.

Best suited functions for milling machines!

Zero approach machining [INC mode] KA-200 Counter

Zero approach machining can be repeated at preset intervals. Since the counter keeps the total displacement in absolute coordinates, a positioning error made by the operator at one tooling position has no effect on the remaining positions.

Errors due to table positioning by the machine are automatically corrected to the next target value.

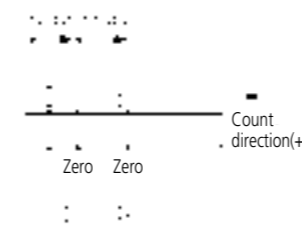

Pitch machining KA-200 Counter

Bores multiple holes between two arbitrary points in the X-Y plane at equal pitch. By inputting the number of holes and positions of the start and end points, holes can be bored easily at equal spacing.

Errors due to table positioning by the machine are automatically corrected at the next target value.

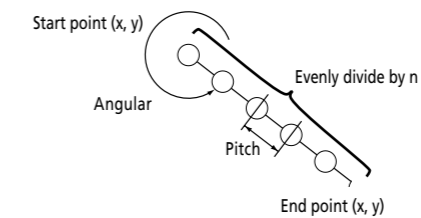

Scale reference point setting SET

● Scale reference point
The position reference marked on the glass scale of the scale unit is the absolute origin point and it has highly accurate positional reproducibility. When the scale absolute point is passed through, a count from the preset values (zero-set or preset values) or a value to be displayed when passing through can be fixed. That is, it can be used when memorizing or reproducing the machine origin or the machining reference point.

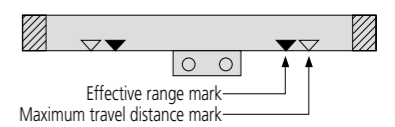

Absolute points of the scale are engraved every 50 mm between the effective range marks (▽-marks).

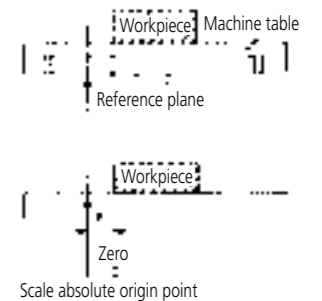

Bolt-hole circle machining KA-200 Counter

Machining can be easily performed by entering the diameter of the dividing circle (bolt circle) and the division number and performing zero-approach machining.

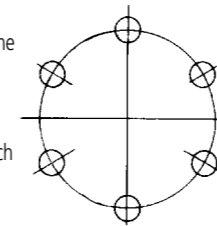

Special functions for lathes!

Diameter display DIA

The doubled scale displacement can be displayed. This convenient function can be used to display the diameter of a workpiece during a turning operation.

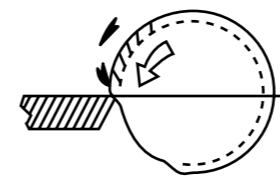

Addition of 2-scale data KA-200 Counter

Mounting a second scale on the finely-fed upper slide enables counting the total travel distance when two machine slides are movable along the same axis.

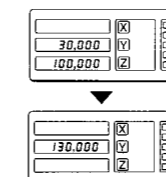

Memorization of machining reference point for each cutting tool KA-200 Counter

Absolute coordinate and incremental coordinate can be switched by every one of four cutting tools. The counter can memorize the center of a machining workpiece as a reference point and it can display the diameter of the machine workpiece by using absolute coordinate. The counter can zero-set/preset at the arbitrary position by using incremental coordinate.

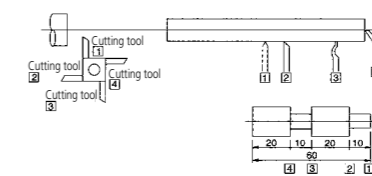

Special functions

Connection with Line Driver Output Scale/Linear Gage

The KA-200 Counter can also connect with a line-driver output type scale and a linear gage. To connect these sensors use optional LINE conversion adapters. For detailed information, refer to page 16.

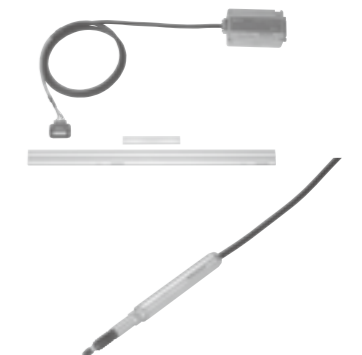

Linear Scale System

Optional Accessories

Special accessories are available for the Mitutoyo linear scale to support various measurement methods.

External Load Box

Outputs counter value just by pressing the button when using the counter's data output function. (For KA-200 Counter (equipped with RS-232C output))

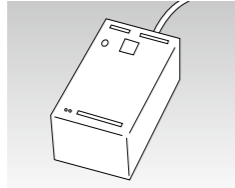

Code No.	Number of axis
937328	3-axis

External Zero-set Box

Performs zero-setting by touch and outputs the currently displayed counter value to external equipment. (For KA-200 Counter (equipped with RS-232C output))

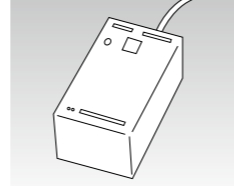

Code No.	Number of axis
936553	3-axis

Note 1: Both of the counter and the external zero-set box have to have the same number of axes.
 Note 2: When using for KA-200 Counter, a cable for external connection is also required.

Digimatic Mini-Processor DP-1VA LOGGER

Display data printing becomes available by connecting the RS-232C output connector of the KA-200 Counter and DP-1VA LOGGER. For connection, use RS-232C Counter cable (1 m). (For KA-200 (RS-232C output) Counter.)



Code No.	Product name
264-505	DP-1VA LOGGER
Code No.	Product name
09EAA094	RS-232C counter cable

Code Out Unit (For KA-200 Counter)

This is a code out unit for RS-232C output. Communication with a PC is available using each command. Text data output using USB becomes available in combination with a foot switch.
 Note: USB output using commands from a PC is not supported.

Code No.	Product name
06AET993	Code Out Unit
937179T	Foot switch

Counter Support

Supports for various counters. Desk-top, turnable-arm, turnable-double-arm, stand, and special type are available. (The support type depends on the counter. Please specify your counter so that we can select the appropriate support for you.)

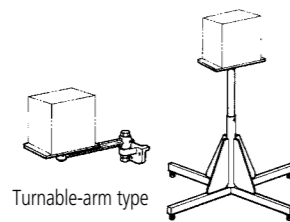

External Load Foot Switch

Outputs counter value just by stepping on the switch when using the counter's data output function. (For KA-200 Counter (equipped with RS-232C output))



Code No.	965004
----------	--------

Note: When using for KA-200 Counter, a cable for external connection is also required.

Cable for External Connection

External zero-set box, external load box and external load foot switch can be used when connected with RS-232C output of KA-200 Counter. Combination use with RS-232C output is available.

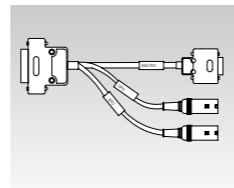

Code No.	06ACF941
----------	----------

Extension Cable

Extends the cable length of a Linear Scale when there is a distance between the Linear Scale and a counter. For detailed information, refer to page 17.



For AT100 Series

Code No.	Cable length
09AAA033A	2 m
09AAA033B	5 m
09AAA033C	7 m

For AT715

Code No.	Cable length
09AAB674A	2 m
09AAB674B	5 m
09AAB674C	7 m

Various Adapters

Mitutoyo provides a variety of adapters, meeting various applications. (Refer to Pages 15 to 16 for details.)

- Connecting adapters for former Linear Scales and existing counters (KA-200 Counter)
- Connecting adapters for existing Linear Scales (AT100 Series) and former counters.
- Connecting adapters for line-driver-output Linear Scales, various sensors and existing counters (KA-200 Counter)

Linear Scale System

Adapter Configurations

Optional Adapters

Adapters for Connecting between Older and Current Products

A specific adapter may be required for connecting between an older product and a current product. For applicable connecting adapters, refer to the following configuration diagrams. An adapter is connected to the input connector on a counter.

The early 1 μm linear scales are not compatible with KA counters.

Also, linear scales from the AT715 series are only compatible with the KA series counters.

- Adapter configurations for connecting between a current linear scale (AT100 Series) and an older counter

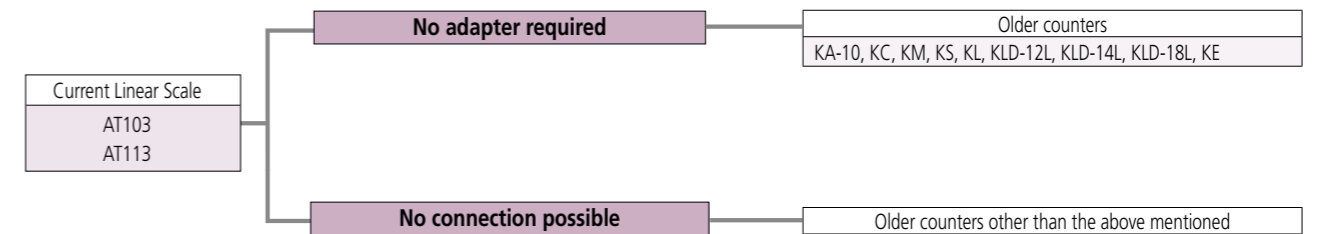

- Adapter configurations for connecting between a current counter and an older linear scale

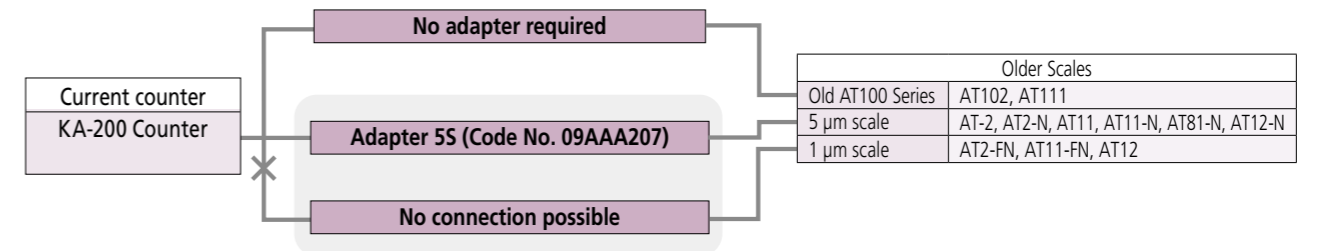

Linear Scale System

Line Conversion Adapter

Connects a line-driver-output Linear Scale, a Linear Gage and a KA-200 Counter.

- Configuration of line-driver-output models and connecting adapters for the KA-200 Counter

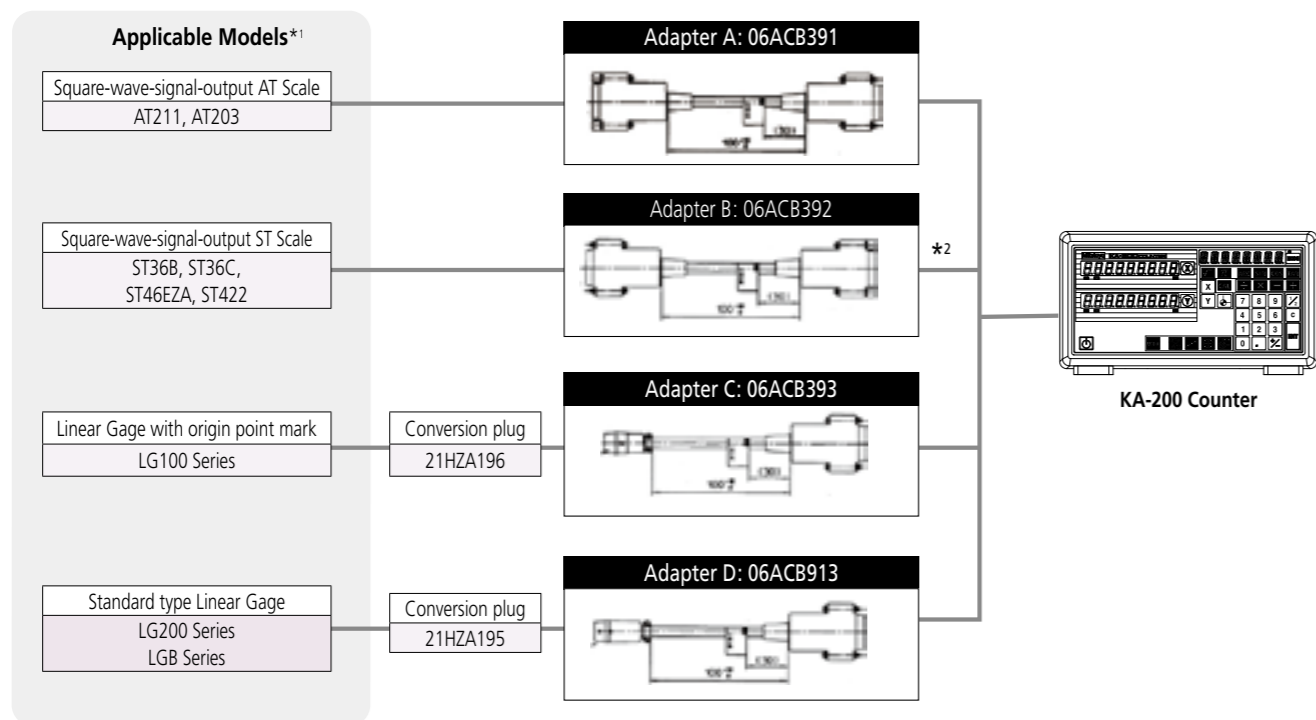

*1: For details regarding square-wave-signal-output scales and Linear Gages, refer to leaflet No. E13005 "NC Linear Scale Systems" and No. E13007 "LINEAR GAGE".

*2: A cable between adapter A and the counter is required.

Use an optional connecting cable for ST Series (2 m/3 m/5 m), or make a connecting cable to the counter using a connector provided with a ST Scale as standard. Other adapters than Adapter B can be directly connected to the counters.

CAUTION

When using adapters A to D, maximum response speed is determined by the resolution of the connected models.

- When the parameter 96 of the KA-200 Counter is set to 5 (input frequency: 300 kHz)

Connected model's resolution	Maximum response speed
1 μm	300 mm/s
0.5 μm	150 mm/s
0.2 μm	60 mm/s
0.1 μm	30 mm/s

Connecting to External Devices

Connection diagram

Machine slide travel distance data and limit switch signals for a machine tool or measuring machine can be output to a PC using the optional RS232/USB interface.

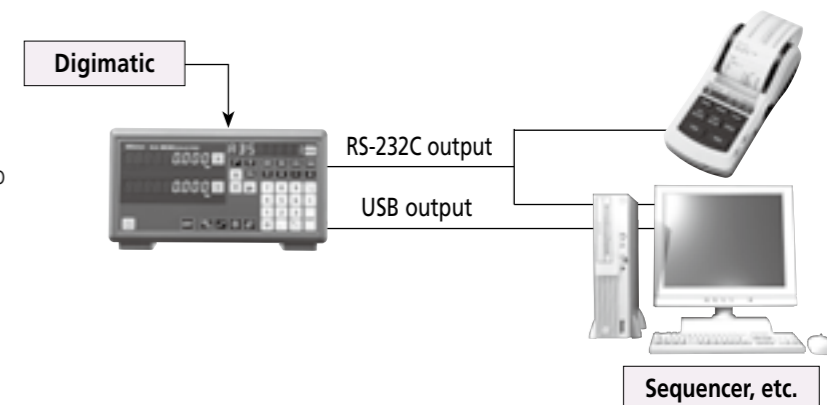

RS-232C Input and Output

Data transmission/reception is available using request commands from a PC.

Communication with a PC and printer is available using an RS-232C interface.

Common specification

DATA OUTPUT MODE

Data output can be selected from two modes: the trigger mode that outputs data by commands input from an external load signal or a PC, and the interval mode that outputs data at regular intervals. The interval mode is supported by the KA-200 Counter and the trigger mode is supported by all models.

SPECIFICATIONS

1) Communication specifications*

- Home position : DCE
- Communication method : Half duplex
- Data transfer speed : 300, 600, 1200, 2400, 4800, 9600, 19200, 38400 bps
- Parity bit : NO (n/a), EVEN, ODD
- Data bit : 7 bit
- Stop bit : 1 bit

* The setting is switchable by parameter.

2) Operation for data output

1. Output of counter display value in the trigger mode
Counter display values can be output in the following ways. Only one signal type can be used for input at any one time.

Method	Counter mode	Output axis	Applicable counters
Data request command X (CR) (LF) Y (CR) (LF) Z (CR) (LF) A (CR) (LF)	Normal mode	X Y Z All axes	KA-200 Counter
External extension cable and external load box	Normal mode	Axes that are selected by the external load box	KA
External extension cable and foot switch	Normal mode	All axes	KA

2. Control the counter from external equipment
The counter is controllable from a PC using the following commands. Command codes must be entered in upper-case characters.

Function	Command code from PC
Zero-setting Sets the counter display values to zero.	RX (CR) (LF): X-axis zero-setting RY (CR) (LF): Y-axis zero-setting RZ (CR) (LF): Z-axis zero-setting
Error cancellation Has the same effect as the CANCEL key on the counter.	CO (CR) (LF)

3) Error code output

If a data output command is issued when the counter is in an error status, or when an incorrect command is issued, the counter outputs a corresponding error code signal.

Counter display	Code out output
Count overspeed (Error20)	E20
Display overflow (Error30)	E30
Signal error (Error40)	E40
Internal error (Error60)	No response
Startup display (-----)	E00

CAUTION

- The output data format is fixed to either 7 or 8 digits, without zero-suppression.
e.g. X + 0000.000 (CR) (LF)
- If data is output from multiple axes, a comma "," is used as a delimiter.
- Data is output in the same unit that is used on the counter (mm or inch). However, the unit identifier itself will not be output.

Connecting to External Devices

4) RS-232C connectors

The output connector of the code out unit for the KA-200 Counter is a 25-pin type.

25-pin specifications (KA-200 Counter)

Pin No.	Signal	Remarks	Signal direction (Counter ↔ PC)
1	FG	Frame grounding	—
2	SD	Command	←
3	RD	Data	→
4	—	Not used	—
5	CS	"H" fixed	→
6	DR	"H" fixed	→
7	SG	Signal grounding	—
8 to 12	—	Not used	—
13	XLOAD	X-axis load	←
14	YLOAD	Y-axis load	←
15	—	Not used	—
16	ZLOAD	Z-axis load	←
17	—	Not used	—
18	ALOAD	X-, Y-, Z-axis load	←
19 to 22	—	Not used	—
23	XZERO	X-axis zero-setting	←
24	YZERO	Y-axis zero-setting	←
25	ZZERO	Z-axis zero-setting	←

Note: Refer to "(7) External extension cable" for how to use the external load box and external zero.

- Applicable plug (male): HDBB-25P (plug/HIROSE)
HDB-CHT (case/HIROSE)

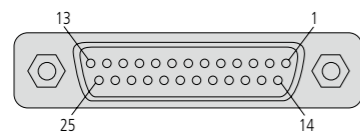

5) About connection cables

Use a straight cable to connect with a PC. No cable with compatible connectors is provided with the product. Please purchase commercial products separately.

6) Connecting to the DP-1VA LOGGER (KA-200 Counter only)

Display data printing becomes available by connecting the 25-pin output connector of the code out unit for the KA-200 Counter and DP-1VA LOGGER. When connecting, use the RS-232C counter cable (09EAA094) sold separately.

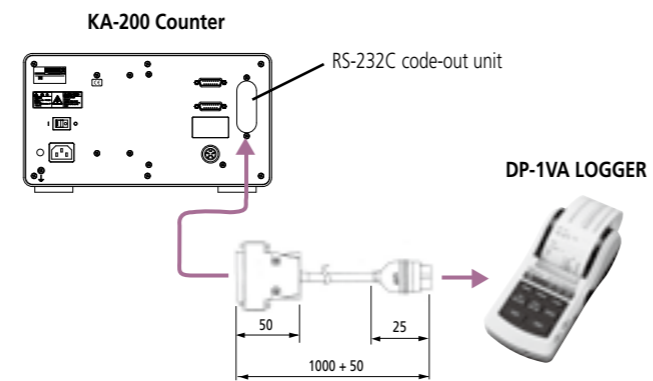

7) External extension cable

By attaching an external extension cable to a KA-200 Counter + RS-232C code-out unit, the optional external load box, foot switch and external zero set box can be connected. RS-232C outputs can be used together.

● Configuration

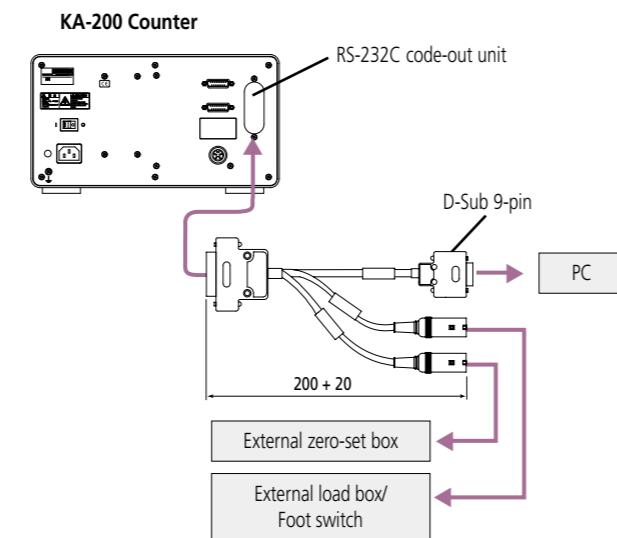

TIMING CHART

1) Outputting data a fixed time after startup (Interval Mode, KA-200 Counter only)

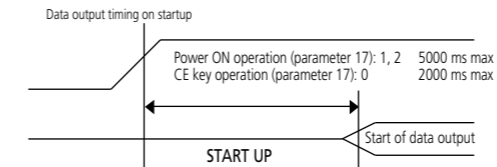

Note: The display mode at startup can be selected with a parameter (KA-200 Counter).

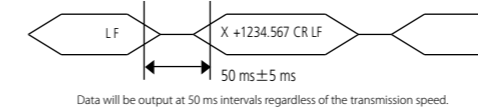

2) Inputting commands from external equipment (Trigger Mode)

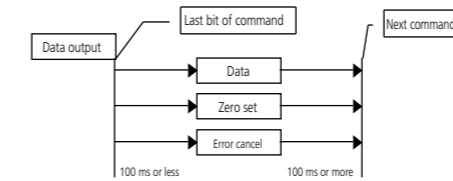

Note: Each value in the timing chart indicates response time to a command. Consequently, be aware that this command may cause a difference between the detected point value and the actual point value when the slider is moving.

3) External zero-set signal

- Input signal



Note: Maintain the low level for 100 ms or more.

■ USB Output

A KA-Series counter can output measurement values as USB text data in combination with the optional code output unit and foot switch.

These numeric values can be imported to applications such as Excel.

- Code Output Unit (06AET993)

Note: Connector specification: USB 2.0 type

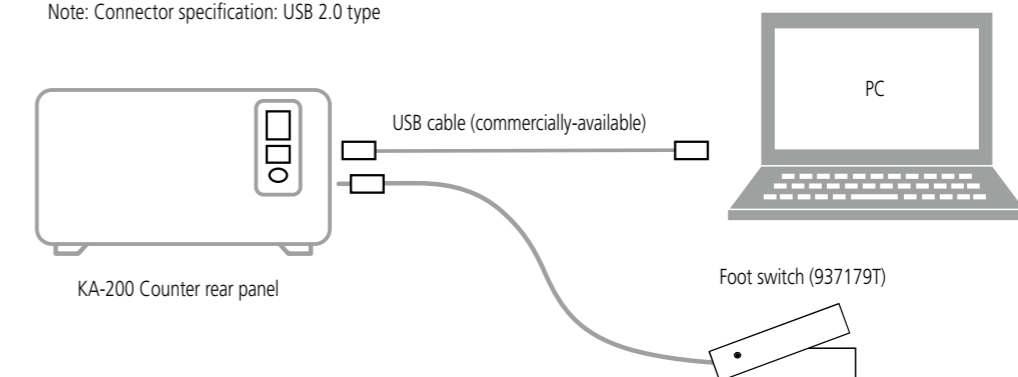

Precautions when mounting and handling Linear Scales

Selecting the scale unit mounting position and mounting method

It is important to keep in mind the following four points when determining the scale unit mounting position and orientation.

Ease of mounting

Mount the scale unit making sure that the unit including the detector head and the cables does not interfere with any part of the machine. To facilitate mounting, mount the scale unit and the brackets on machined surfaces wherever possible.

Protection from machining fluids and swarf (mounting orientation)

The scale unit is constructed in such a way that machining fluids and swarf cannot easily enter into the interior of the unit. However, since the openings are protected from entry of foreign material with rubber seals only, avoid directly exposing the scale unit to machining fluids and swarf. Select the mounting orientation of the scale unit after carefully considering the direction in which machining fluids and swarf are sprayed and scattered.

Accuracy considerations

The total system accuracy of the machine on which the scale unit is mounted is not only determined by the scale unit accuracy but by the machine accuracy as well. Particularly for machines with slide tables, geometrical errors may occur, depending on the straightness of moving parts; Thus, the scale unit must be mounted in a way that these errors are minimized. If the slide table moves not linearly but curvilinearly, errors occur in proportion to the distance "L" between the scale unit and the machining point (cutter position). Thus, mount the scale unit in a position that minimizes "L".

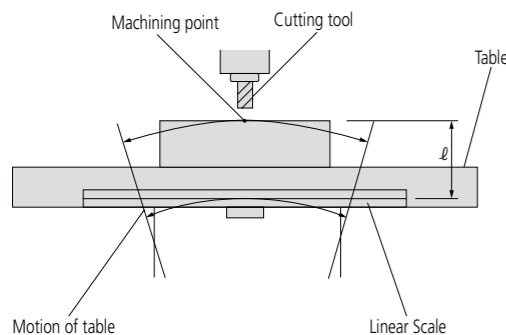

Other considerations

- If the detector head moves, the signal cables also moves with the slide table. This should be considered when laying out the signal cables. It is therefore recommended to mount the scale unit on the moving part of the machine.
- Mount the scale unit in a place where it is not directly subjected to airflow. When removing swarf using an air gun, be careful of flying swarf.
- The scale unit must be mounted in a place where maintenance can be easily performed.

Checking parallelism and adjustment of scale unit

In order to attain maximum accuracy, the scale unit must be mounted parallel to the machine guide (machining axis). Incorrect mounting may cause the scale unit to bend or twist.

Checking parallelism

Use a dial indicator as shown in the figure below. To adjust the parallelism between the scale unit and the machine guide, check the parallelism while manually moving the machine's movable part such as the slide table, or measure the parallelism with reference to the guideways of the machine or equivalent reference surface.

- Parallelism tolerance: Refer to scale specifications.
- Checking direction: Back/forward direction on mounting surface and directions along mounting surface (up and down).
- Checking position: Position of the scale unit near the mounting plate and the mounting block

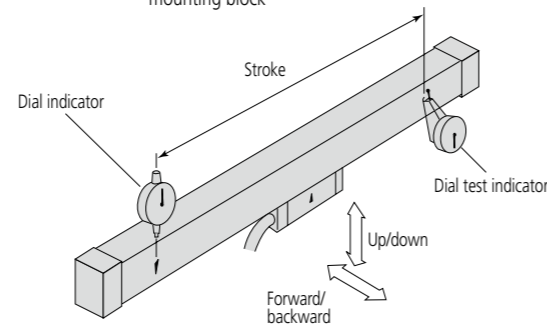

Adjusting parallelism

Adjust the parallelism to within 0.2 mm. Spacers used in adjustment are not included in the accessories.

Adjusting the mounting surface back/forward

Readjust the mounting position of the bracket, or adjust by inserting a spacer between the scale mounting surface and the mounting block or the mounting plate.

Adjusting along (up and down) the mounting surface

Adjust by sliding the mounting block or the mounting plate onto the mounting surface.

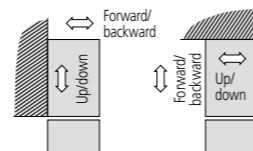

Information about Air Supply (Improvement in Dust and Oil Resistance)

Feeding clean compressed air into the scale unit is provided as a means of improving the environmental resistance (to coolant and dust) of assembly-type linear scales. This is done by piping air to either of two M5 screw holes situated on the sides of the scale unit.

Note: AT103 is equipped as standard with an air supply fitting.

Caution: This air supply method is suggested as optional protection for the scale.

The installation of the air supply piping is important and should be implemented as described in the manual. The air should be filtered and the filter replaced periodically, depending on the cleanliness of the air source. Continued use of a heavily contaminated filter may allow contaminants to pass into the scale unit.

For detailed information, contact the nearest Mitutoyo Sales Office.

Cautions on handling signal cable for linear scale

It is important to keep in mind the following points when deciding on the layout scheme for signal cables.

When the cable is fixed

The radius of curvature of the signal cable must be larger than 50 mm.

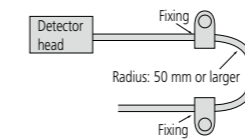

When the cable is movable

When the detector head is the moving element, it carries the signal cable with it during operation. Take care, in such a case, that the radius of curvature of the signal cable is not smaller than 100 mm and excessive force is not applied to the cable. It is a good idea to protect the cable with a flexible support cover.

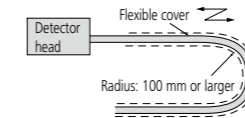

Note: It is important to ensure that the signal cable does not interfere with, and is not chafed by, any part of the machine.

Other considerations

The signal cable is durable enough to withstand repeated bending up to approximately 2 million times (when the bending radius is limited to more than 100 mm). When repeated bending exceeding 2 million times is expected, the signal cable should be considered as a consumable part. In such a case, carrying a spare cable will allow immediate replacement when necessary and so minimize machine downtime.

Resonance frequency of Linear Scale

Each object has a natural frequency of oscillation, depending on its shape, length, and the type of material. The Linear Scale frame is not an exception. It has its natural frequency and thereby resonates at a certain frequency. In general, this will not cause a problem, since a machine tool and the Linear Scale frame have different natural frequencies under normal machining conditions. However, should the natural frequency of the machine tool body and the Linear Scale coincide, which can lead to performance abnormalities due to excessive vibration amplitude, the following counter-measures can be taken.

[Remedy]

Remedy for scale

1. Increase rigidity of the mounting bracket for the scale.
2. Add a mid-support to the middle of the scale to shift its resonance point higher.

Remedy for machine

3. Mount the Linear Scale at a place where vibrations from the machine tool cannot be easily transmitted.
4. Limit the machine process conditions to be within a specific range in which the natural frequencies of the machine tool and the scale do not coincide.

Maintenance of dust-proof seals

In order to maintain and extend the life of the dust-proof rubber seals, it is recommended that a small amount of silicon lubricant be applied to the contact area between the rubber and the detector head once a year. (The maintenance frequency slightly differs depending on the operational conditions of the scale.)

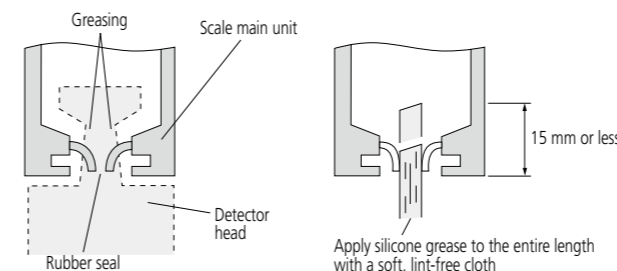

Linear Scale evaluation methods

Testing within the operating temperature range

Testing has proven that there is no abnormality of functions and signals when the Linear Scale is used within the specified operating temperature range.

Temperature cycle (dynamic characteristics) test

Testing has proven that there is no abnormality when the Linear Scale is used under the condition where the ambient temperature continuously changes within the specified range.

Vibration test (Sweep test)

Testing has proven that the Linear Scale functions without abnormality when subject to vibration within the frequency range 30 Hz to 300 Hz at a maximum acceleration of 3 G.

Vibration test (Acceleration test)

Confirms that there is no performance abnormality of a unit subject to vibrations at a specific, non-resonant frequency. (Approx. 10 G)

Noise test

In accordance with the EMC Directive, EN61326-1

Crate Drop Test

In accordance with the heavy equipment drop test (JISZ0200) specified in the JIS standard.

Constructional features of the Linear Scale

1. Joint Structure of Detector

A ball joint structure is employed at the contact area between the detector head and the slider (sensor unit) inside the scale.

This arrangement prevents the slider movement from deviating from the normal moving directions when the detector head is slightly misaligned transversely, thus providing a normal scale reading and increasing flexibility in the scale installation. In addition, this structure is highly rigid and therefore has excellent durability.

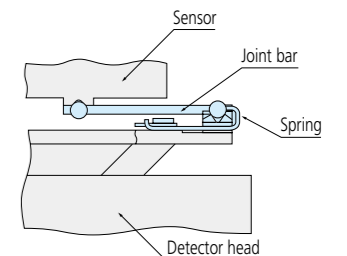

2. Water-proof Connector

A waterproof/splash-proof connector is used to enable separation of the signal cable. Thus, installation and maintenance of the Linear Scale can be easily performed. (Only for AT100 Series)

3. Conduit armored type signal cable

The signal cable is protected by the conduit system. Its exterior is made of stainless steel, which is corrosion-resistant and withstands continuous use.

4. Unique rubber seals

The slider is shaped to glide smoothly through the rubber-seal opening – almost like the keel of a boat through water.

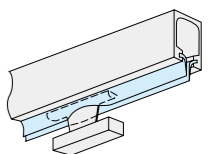

5. Excellent splash- and dust-proof rubber-seal structure

The rubber seals are made of a strong, special urethane, and wires are inserted in these seals to improve the splash-proofing and dust-proofing of the scale.

Note: AT103 only.

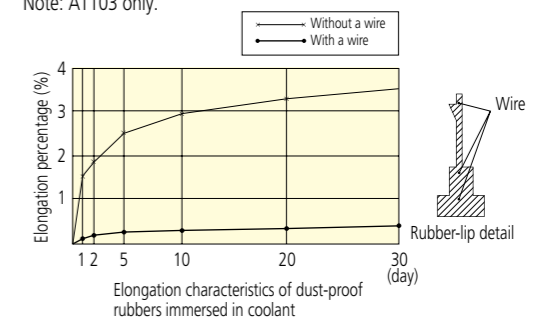

Scale systems for various multi-axis machine tools

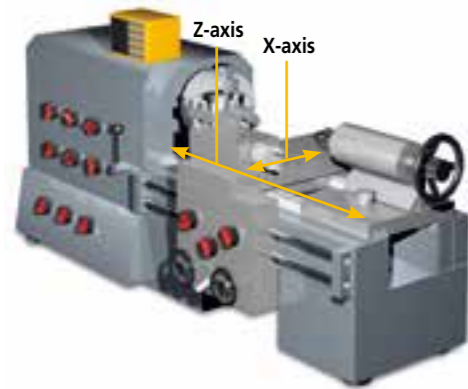

2-axes KA-200 Counter + two scales

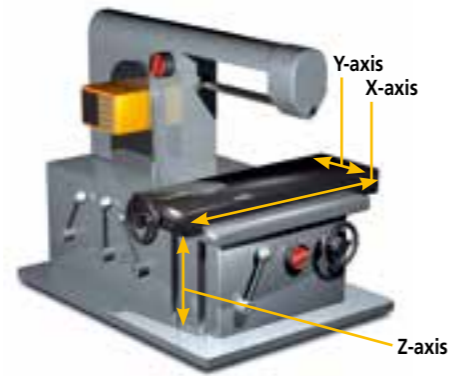

3-axes KA-200 Counter + three scales

Horizontal boring and milling machine

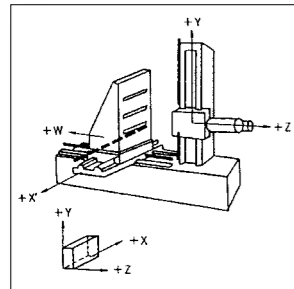

Bed-type milling machine

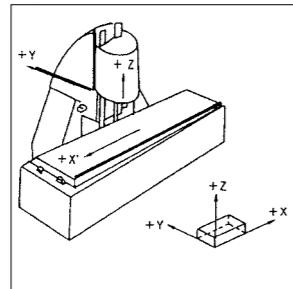

Vertical milling machine, drilling machine, and jig borer

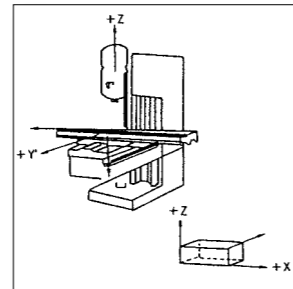

Surface grinder

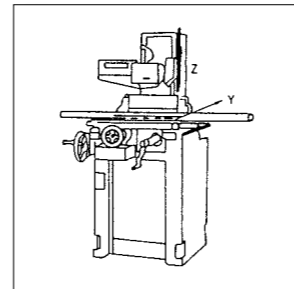

Cylindrical grinder

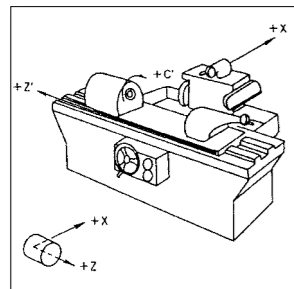

Horizontal borer

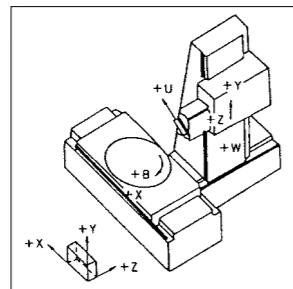

Vertical turret lathe, vertical lathe

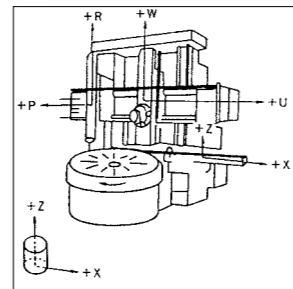

Center lathe

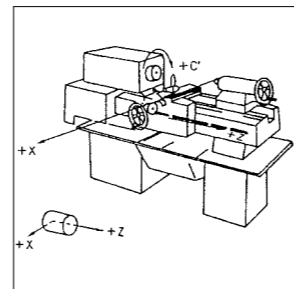

Electrical discharge machine

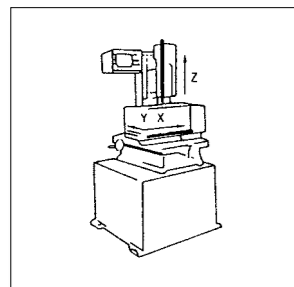

Bridge type planomiller

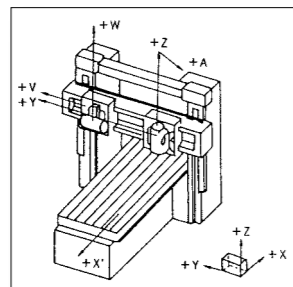

Tool grinder

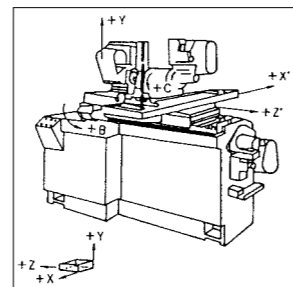

Open-sided planer

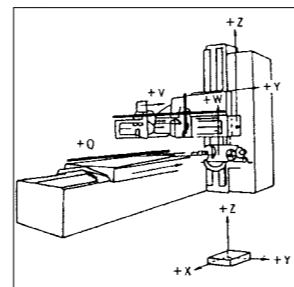

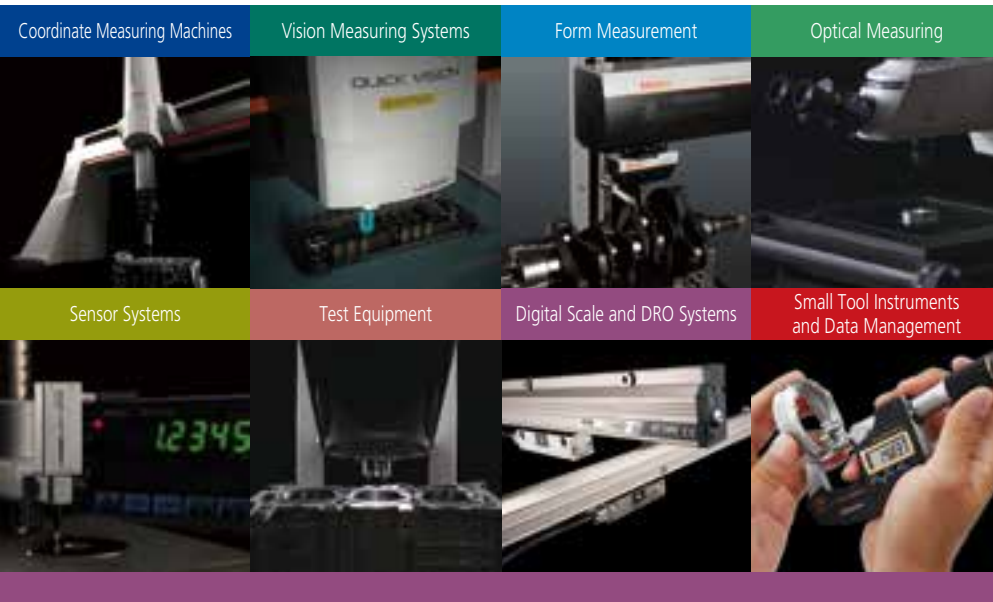

Whatever your challenges are, Mitutoyo supports you from start to finish.

Mitutoyo is not only a manufacturer of top quality measuring products but one that also offers qualified support for the lifetime of the equipment, backed up by comprehensive services that ensure your staff can make the very best use of the investment.

Apart from the basics of calibration and repair, Mitutoyo offers product and metrology training, as well as IT support for the sophisticated software used in modern measuring technology. We can also design, build, test and deliver measuring solutions and even, if deemed cost-effective, take your critical measurement challenges in-house on a sub-contract basis.



Find additional product literature and our product catalogue

<https://www.mitutoyo.co.jp/global.html>

Notes on Export Regulations:

Do not commit an act, which could directly or indirectly, violate any law or regulation of Japan, your country or any other international treaty, relating to the export or re-export of any commodities.

Note: Product illustrations are without obligation. Product descriptions, in particular any and all technical specifications, are only binding when explicitly agreed upon.
MITUTOYO and MICAT are either registered trademarks or trademarks of Mitutoyo Corp. in Japan and/or other countries/regions.
Other product, company and brand names mentioned herein are for identification purposes only and may be the trademarks of their respective holders.
All product information contained in this brochure is current as of March 2024.

Mitutoyo

Mitutoyo Corporation

20-1, Sakado 1-Chome,
Takatsu-ku, Kawasaki-shi,
Kanagawa 213-8533, Japan
T +81 (0) 44 813-8230
F +81 (0) 44 813-8231
<https://www.mitutoyo.co.jp>