

PRECISION IS OUR PROFESSION

Introduction to Precision Measuring Instrument Solutions  
— Electric Vehicle xEV Measurement —

**Mitutoyo**

# Mitutoyo Precision Measuring Instruments That Support

## Power Control Unit (PCU)

### IGBT (Insulated Gate Bipolar Transistor)

This is a power transistor which is a major component in an inverter. An inverter is an assembly of semiconductor components.

A **vision measuring system** is effective for high-speed inspection of minute parts such as chip and bonding wires, and a **measuring microscope** is effective at checking chip bonding solder for cracks.

### PCU Cover

A **CNC coordinate measuring machine** that allows automatic contact measurement of complicated 3D form is used for the PCU cover, which is an aluminum die casting.



## Motor

### Motor Core

The use of a **vision measuring system equipped with a touch signal probe** allows effective measurement both of discrete pressed components before lamination, and laminated parts. The vision measurement mode is available for thin, flat, discrete components before lamination and the touch probe mode is available for 3D evaluation of twist and displacement of laminated parts. A **roundness/cylindricity measuring instrument** is also effective for measurement of rotor outside diameter and stator inside diameter.

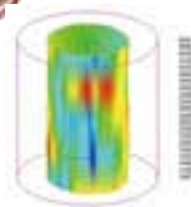

### Coil

A **laser scan micrometer** that allows high speed, high-resolution measurement is effective at measuring the outside diameter of coils used for rotors.

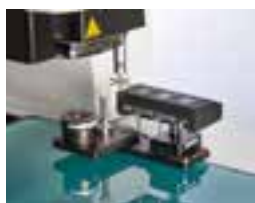

# Development and Production of Electric Vehicles xEV

## Battery

### Lithium-ion Battery

Control over the thickness of the separators that insulate the positive electrode from the negative electrode is absolutely essential for the manufacturing process of lithium-ion batteries (which are subject to explosion or fire risk). The **high-accuracy length measuring machine VL-50** is best suited to this thickness measurement thanks to a low measuring force that minimizes distortion of the material. Also, a **measuring microscope** is used to check for any contamination inside a laminate-type lithium-ion battery.

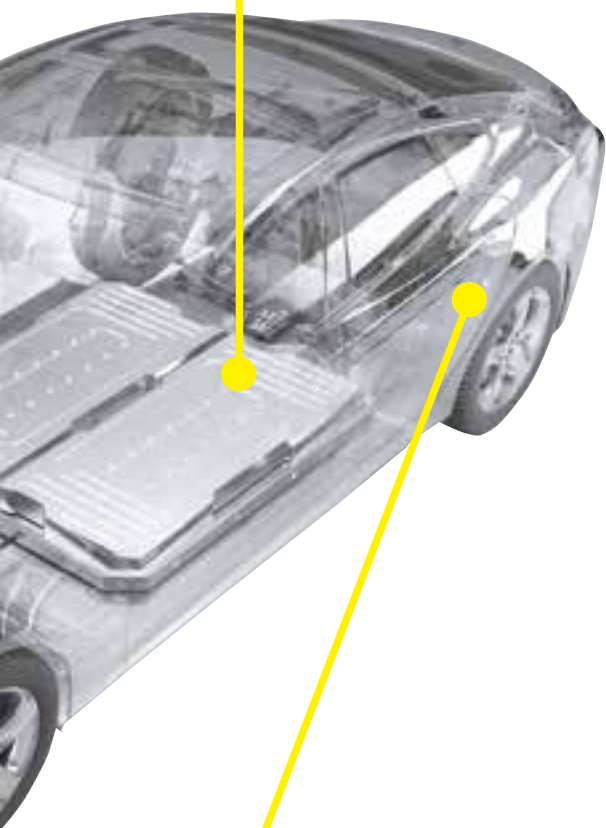
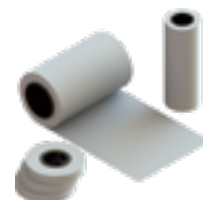

### Fuel-cell Separator

The fuel-cell separator is molded to incorporate flow channels for gas diffusion. The **minute-form measuring system UMAP** that has a minimum probe-ball diameter of 15 $\mu$ m and an ultra-low measuring force of 1 $\mu$ N (minimum) has achieved high-reliability measurement of features such as corner radius, pitch, and angle. For wall-thickness measurement, a **Formtracer** is ideal since it allows continuous measurement of top and bottom faces using with a dual-side conical stylus.

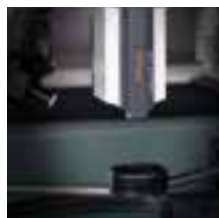

## Battery Charger/ Charger Plug

### In-vehicle Battery Charger

An in-vehicle battery charger includes various parts such as a cover, connector, housing, and relay. Mitutoyo's product lineup - including **coordinate measuring machines**, **vision measuring machines**, **form measuring instruments**, and others - fully cover the many types of measurement required on these components..



### Quick Charger

In order to improve efficiency of the metal terminals in a socket, measurement by a **surface roughness tester** is effective.

### Wiring Harness

A specialized **micrometers** is used for measuring the height of crimped contacts on wiring harnesses.

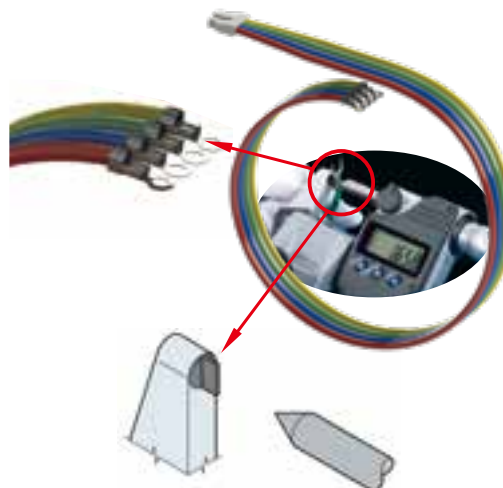

# Solutions to Measurement for Electric Vehicle xEV

Mitutoyo offers solutions to measurement of a wide variety of electric vehicles from research and development to preproduction and mass production.

## Classification of Electric Vehicle xEV

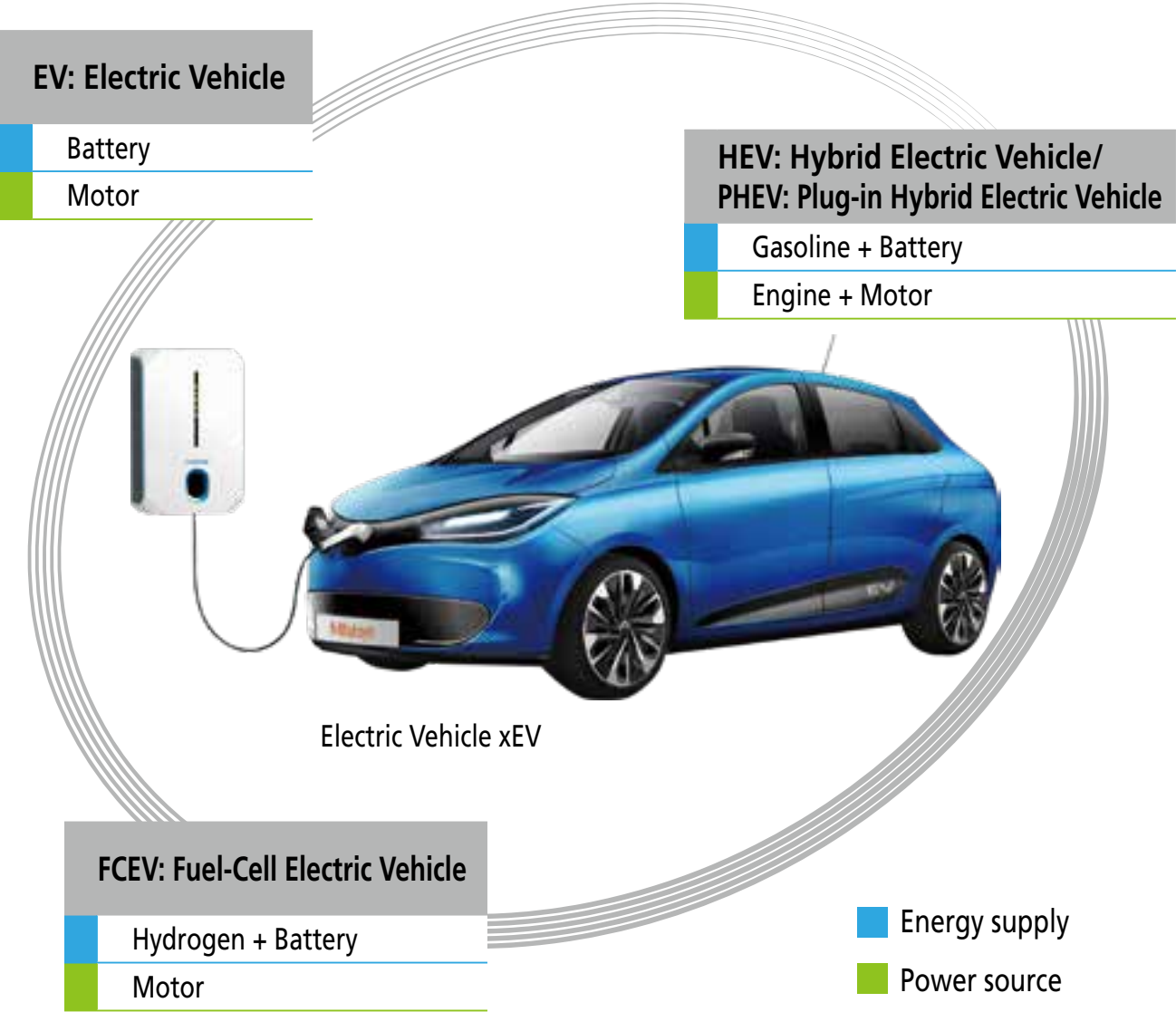

## Precision Measuring Instruments That Support Development and Production of Electric Vehicle xEV

The table below matches Mitutoyo's precision measuring instruments to various applications.

Components		Applications	Coordinate measuring machine	CNC vision measuring system	Minute form measuring system	Form measuring system	Measuring microscope	Precision sensor	Hardness testing machine	Measuring tool
Battery	Lithium-ion Battery	Cover part dimension measurement, surface texture	✓			✓	✓		✓	✓
		Battery case dimension measurement, surface texture	✓	✓			✓		✓	✓
		Separator thickness/width						✓		
	Hydrogen/oxygen fuel-cell separator	Section dimension measurement/observation (presence or absence of contamination)		✓			✓			
		Molded part dimension/form measurement			✓					
		Molded part thickness measurement				✓				
Motor	Motor Core	Unlaminated pressed-part dimension measurement		✓		✓	✓		✓	✓
		Laminated-part dimension, various geometric tolerance measurement	✓	✓		✓				✓
		Rotational axis runout	✓					✓		
	Commutator	Peripheral adjacent gap	✓	✓		✓	✓			
		Bearing coaxiality	✓			✓				
	Coil	Outside diameter						✓		✓
Post-wound form check		✓								
Power Control Unit (PCU)	IGBT*	Various dimensions of power modules	✓	✓		✓	✓		✓	✓
		Various dimensions of semiconductor circuitry		✓			✓			
		Soldered part crack inspection					✓			
		Bonding wire height		✓						
	Inverter housing	Various dimensions of aluminum cabinet, surface texture	✓	✓		✓	✓		✓	✓
Battery charger	In-vehicle Battery Charger	Various dimensions of aluminum cabinet	✓	✓		✓	✓		✓	✓
		Various dimensions of pressed parts	✓	✓		✓	✓		✓	✓
		Connector pin squareness/roughness	✓	✓		✓				
	Quick Charger	Various dimensions of sockets	✓	✓		✓	✓		✓	✓
		Terminal surface texture				✓				
		Various dimensions of panels	✓	✓		✓	✓		✓	✓
Wiring Harness	Height of crimp contact									✓
	Core wire length/diameter		✓			✓	✓			✓

\* Insulated Gate Bipolar Transistor

Coordinate Measuring Machines

Vision Measuring Systems

Form Measurement

Optical Measuring

Sensor Systems

Test Equipment

Digital Scale and DRO Systems

Small Tool Instruments  
and Data Management

### Whatever your challenges are, Mitutoyo supports you from start to finish.

Mitutoyo is not only a manufacturer of top quality measuring products but one that also offers qualified support for the lifetime of the equipment, backed up by comprehensive services that ensure your staff can make the very best use of the investment.

Apart from the basics of calibration and repair, Mitutoyo offers product and metrology training, as well as IT support for the sophisticated software used in modern measuring technology. We can also design, build, test and deliver measuring solutions and even, if deemed cost-effective, take your critical measurement challenges in-house on a sub-contract basis.



Find additional product literature  
and our product catalogue

<https://www.mitutoyo.co.jp/global.html>

#### Notes on Export Regulations:

Do not commit an act, which could directly or indirectly, violate any law or regulation of Japan, your country or any other international treaty, relating to the export or re-export of any commodities.

Note: Product illustrations are without obligation. Product descriptions, in particular any and all technical specifications, are only binding when explicitly agreed upon.

MITUTOYO and MiCAT are either registered trademarks or trademarks of Mitutoyo Corp. in Japan and/or other countries/regions. Other product, company and brand names mentioned herein are for identification purposes only and may be the trademarks of their respective holders.

All product information contained in this brochure is current as of December 2023.

# Mitutoyo

#### Mitutoyo Corporation

20-1, Sakado 1-Chome,  
Takatsu-ku, Kawasaki-shi,  
Kanagawa 213-8533, Japan  
T +81 (0) 44 813-8230  
F +81 (0) 44 813-8231  
<https://www.mitutoyo.co.jp>